

Yarik 540  
Art. Nr. 4015850

1/10

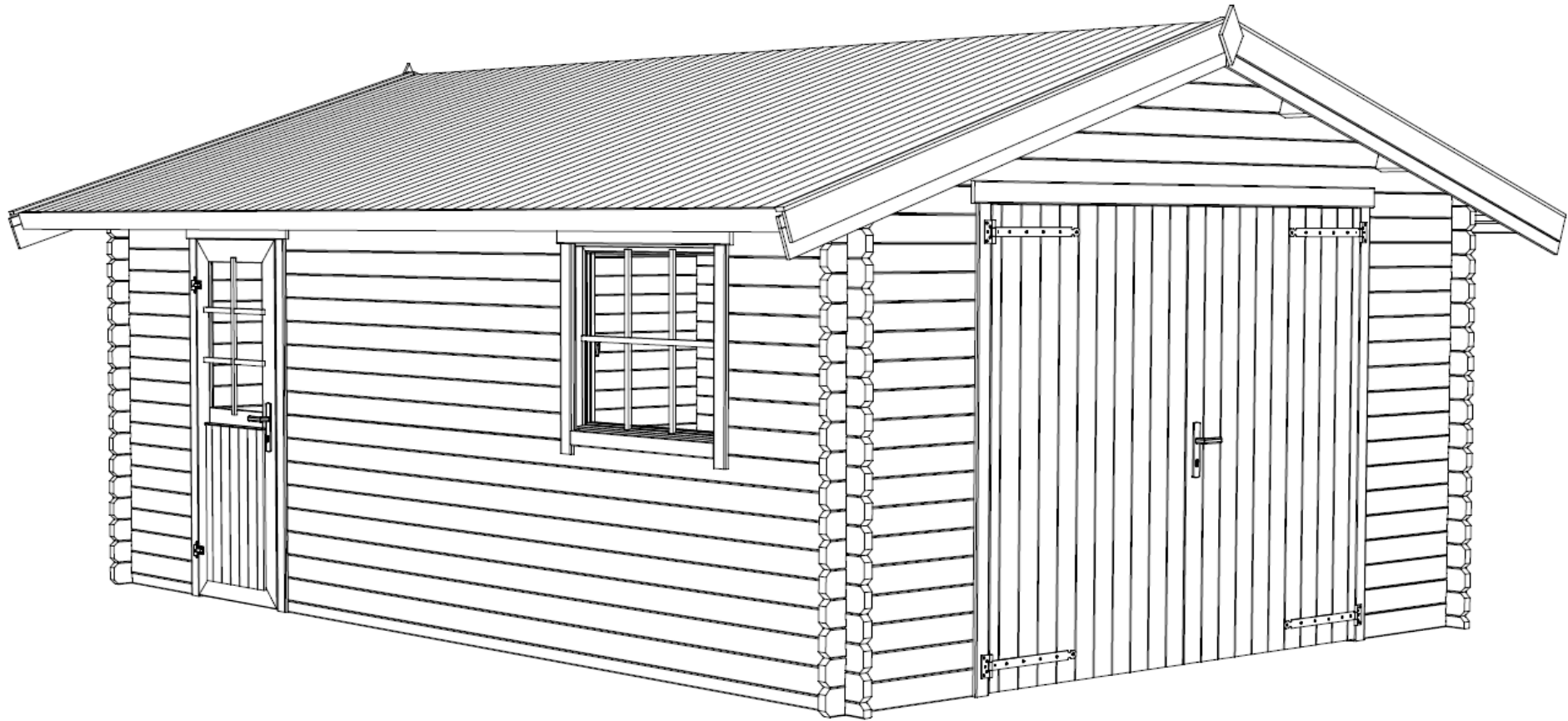

29.09.2017

Art.Nr. 4015850

Groundplan - Grundplan - Plan de masse - Planimetria - Plattegrond - Põhiplaan

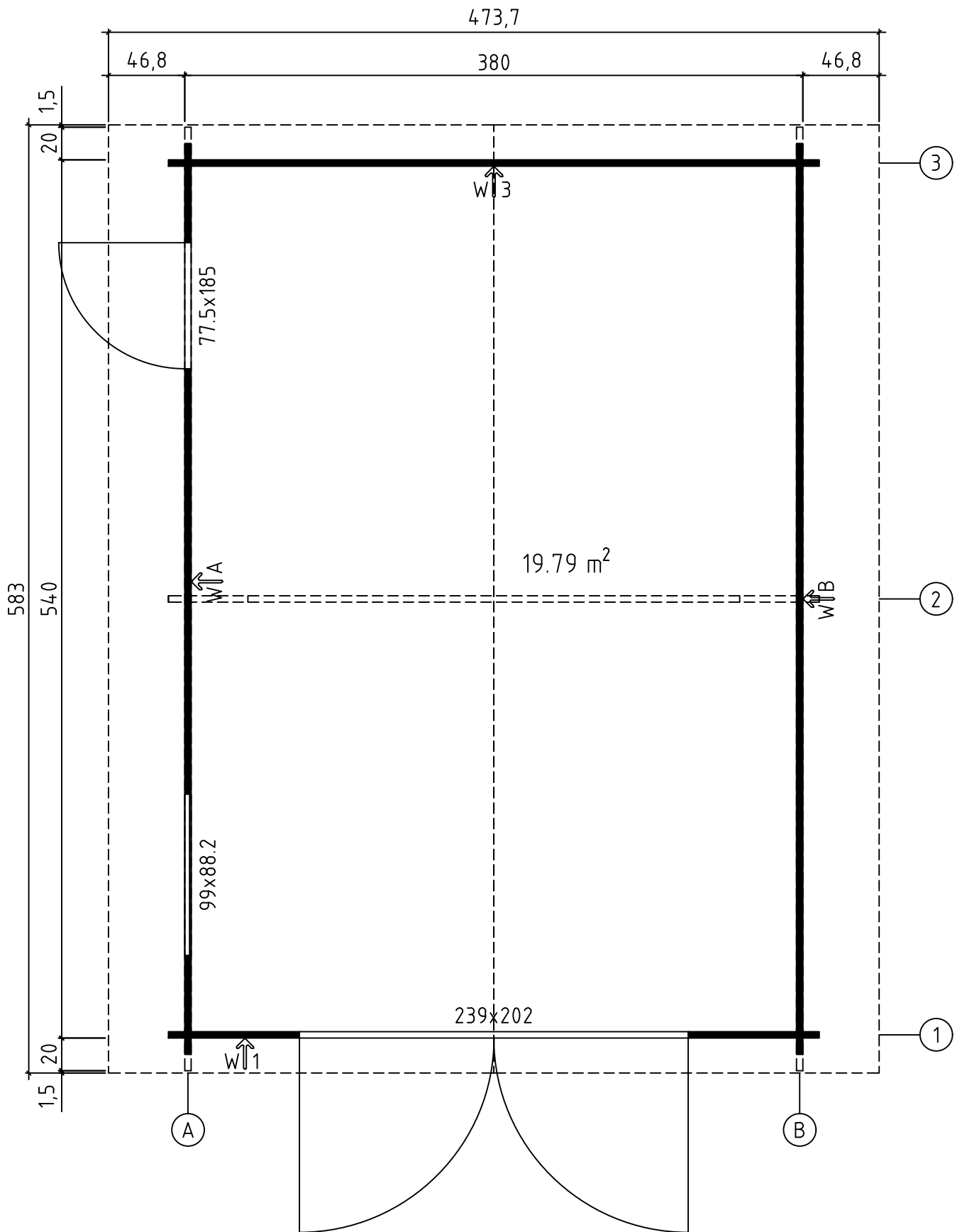





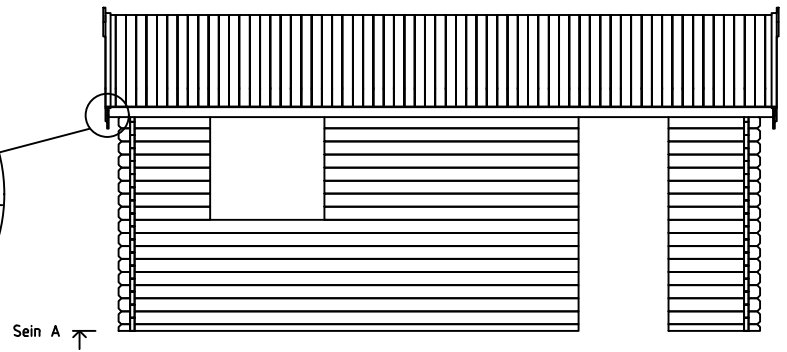
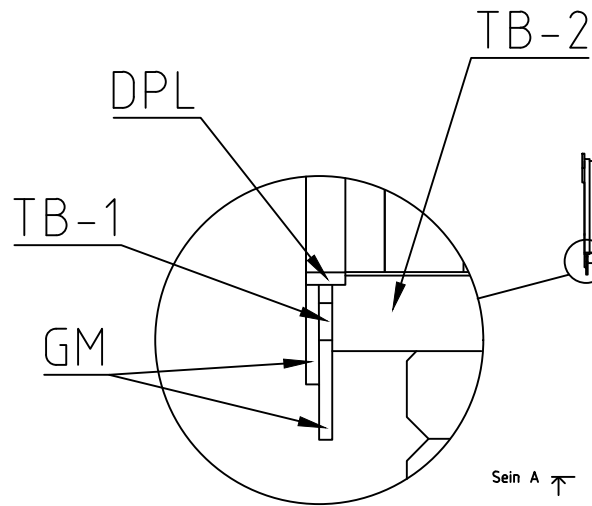
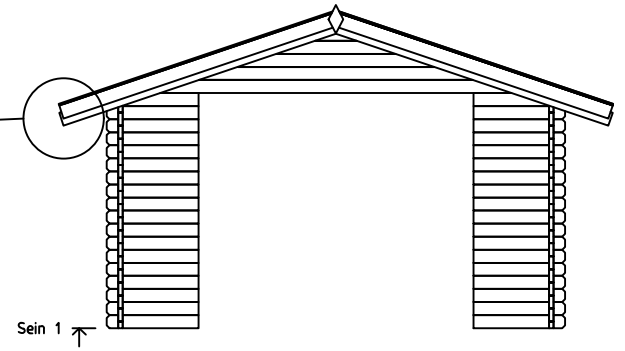
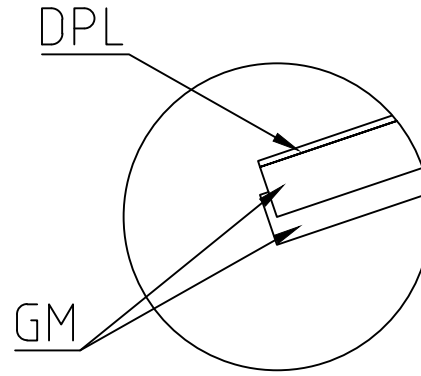
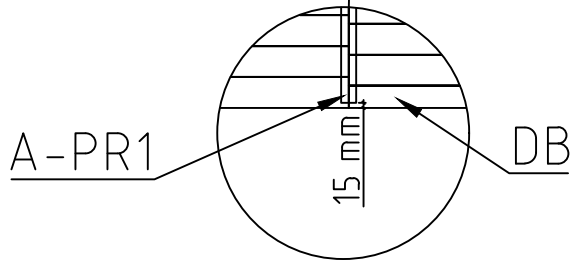
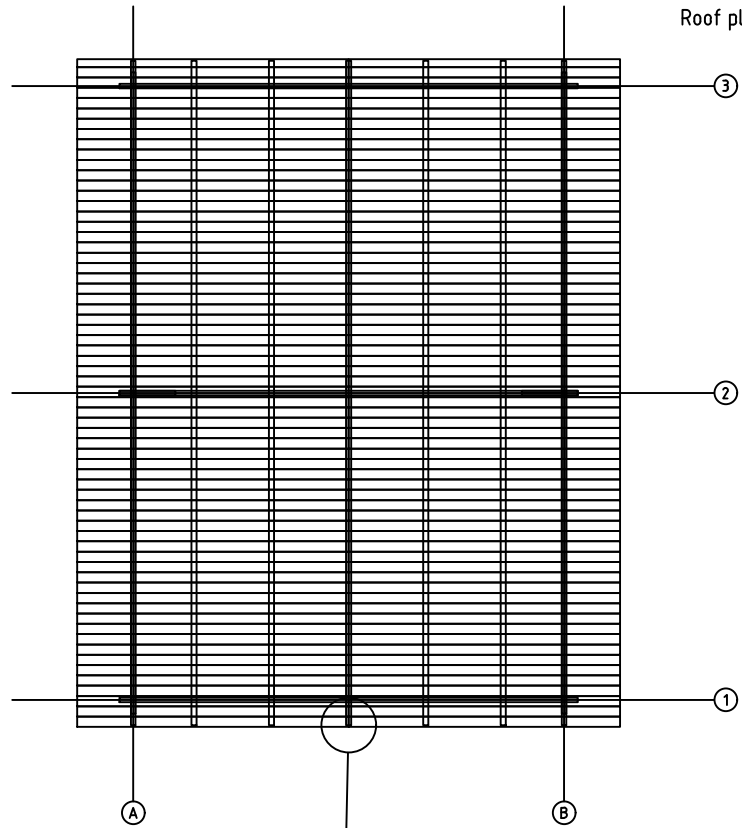

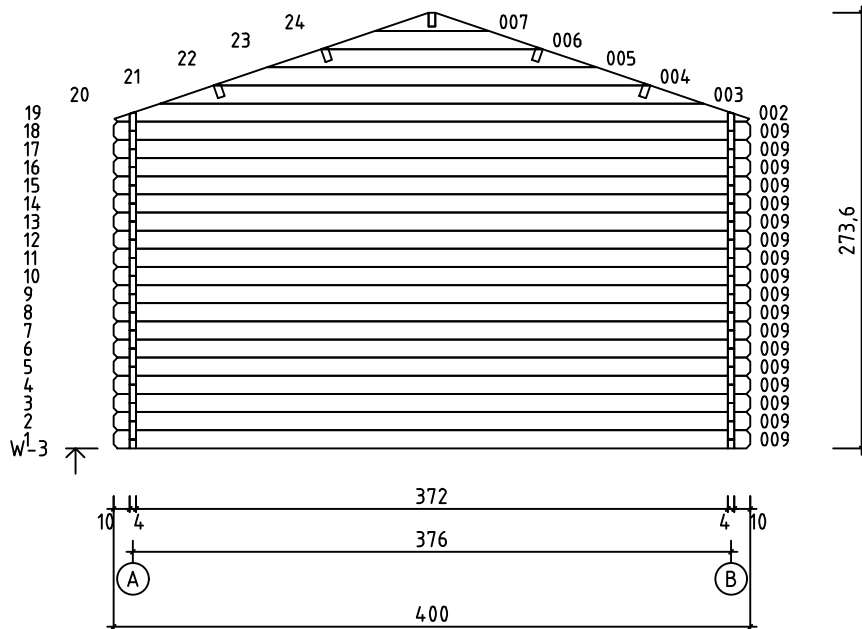
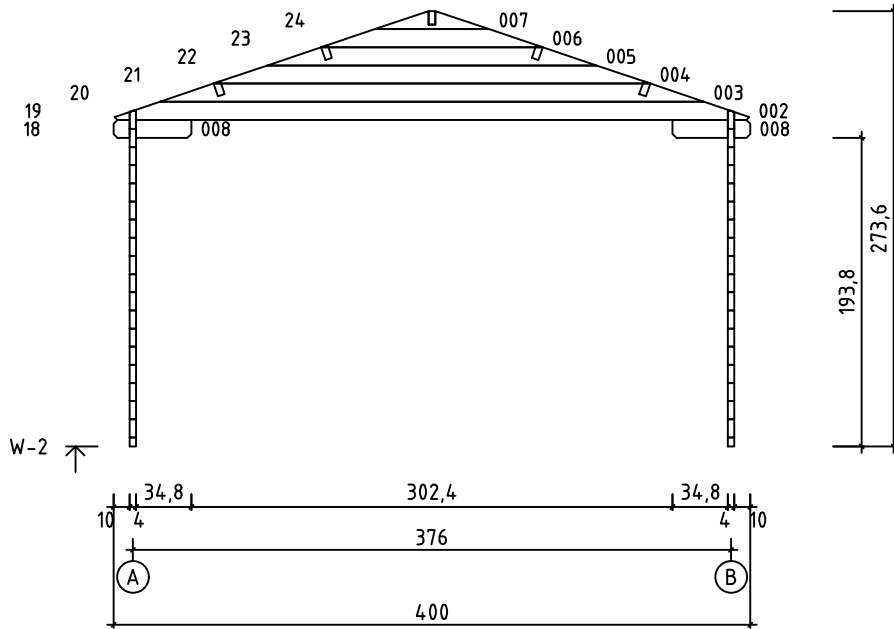
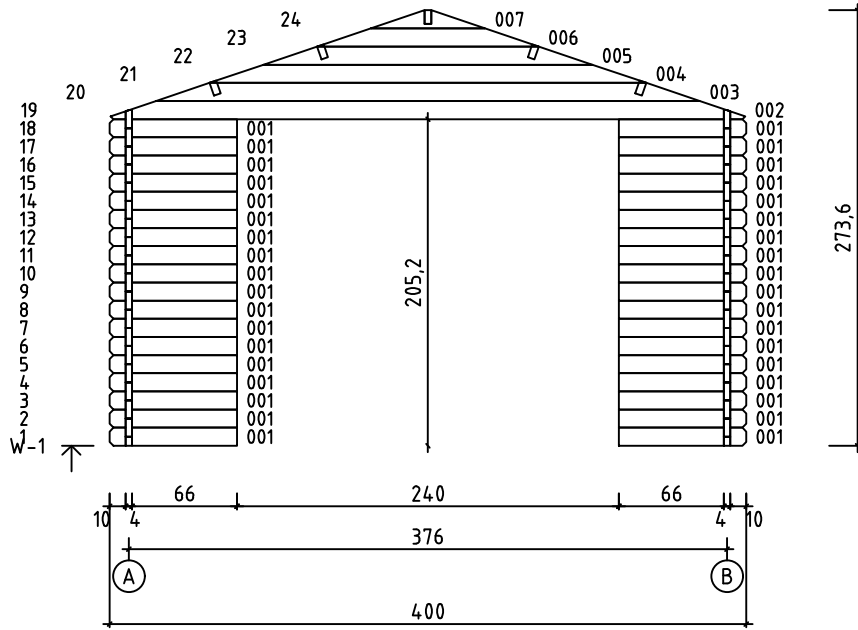
Art.Nr. 4015850

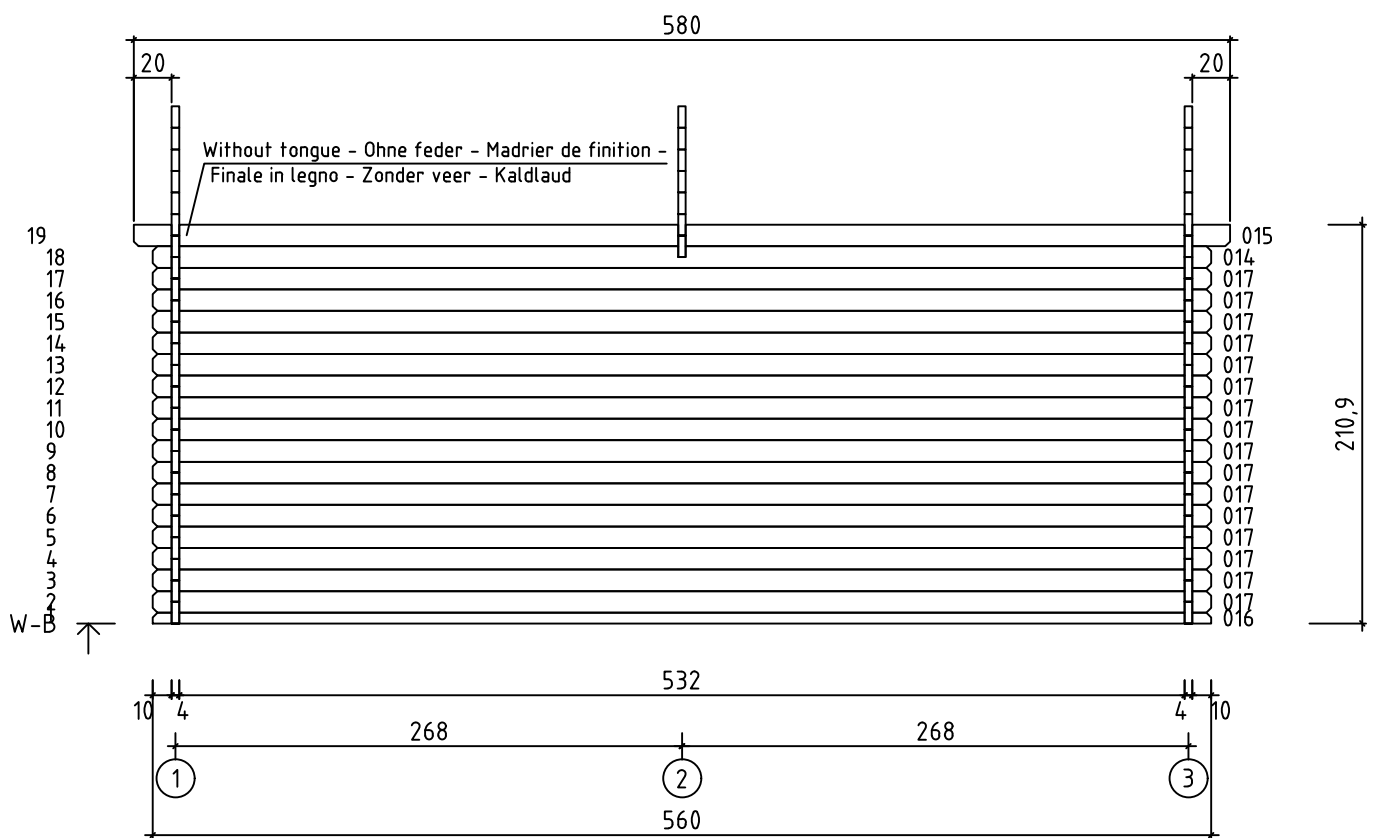
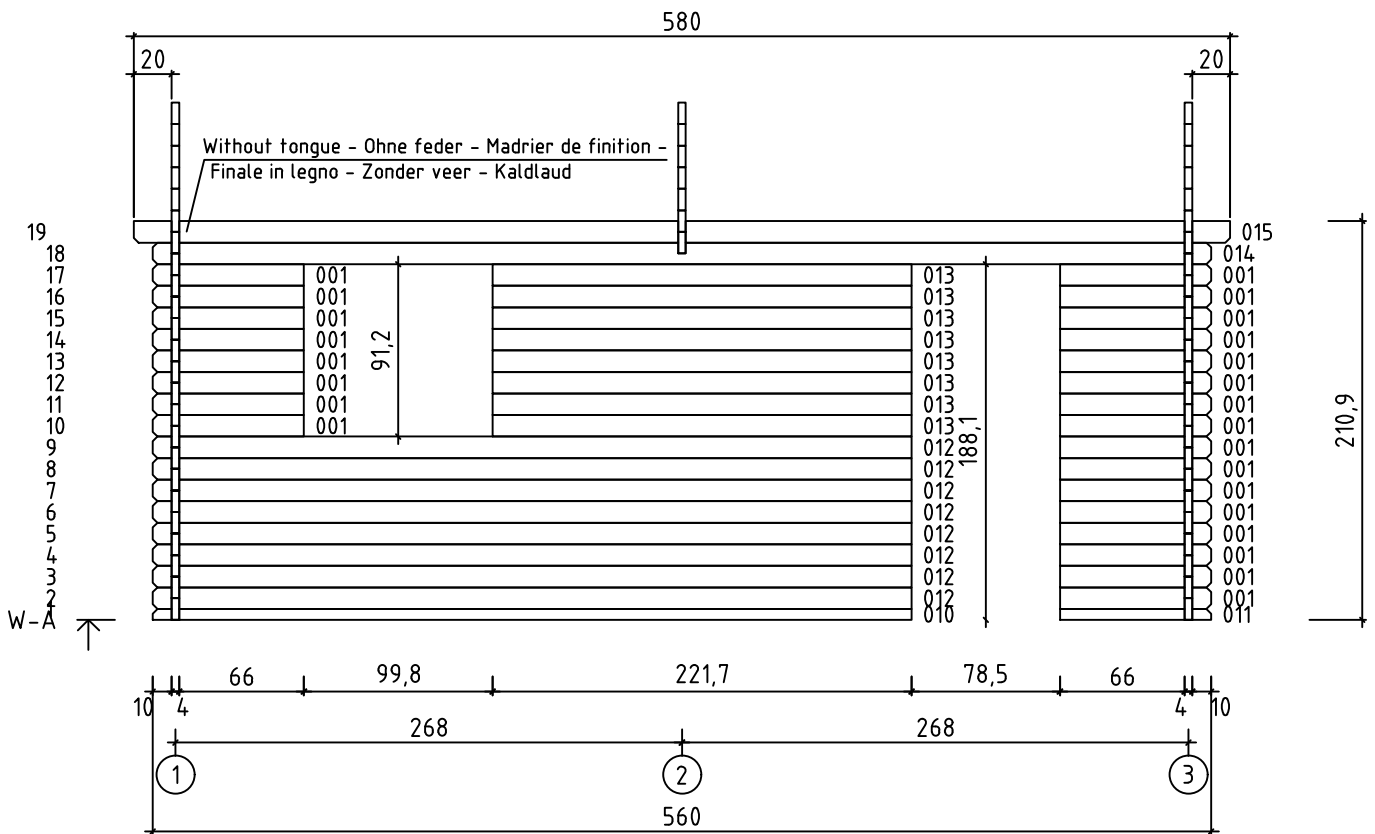

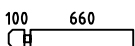

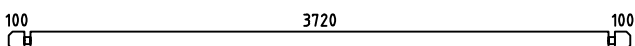
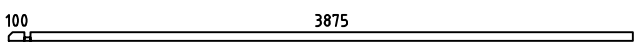
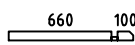
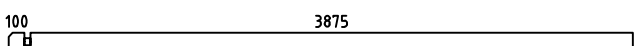
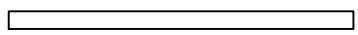
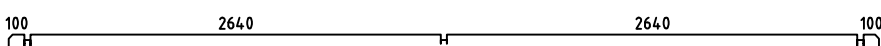
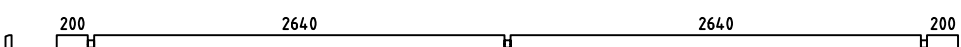
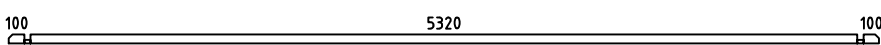
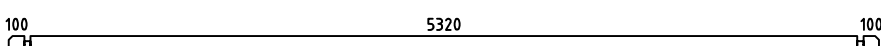
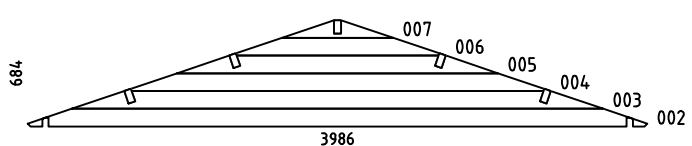
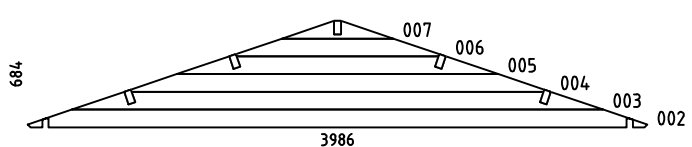
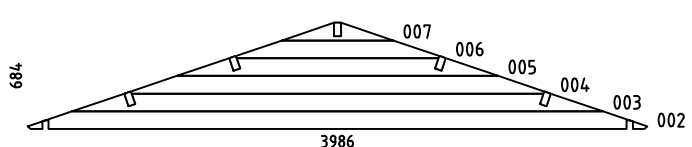
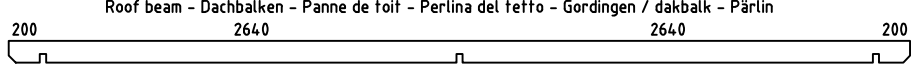
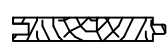

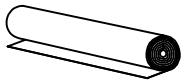



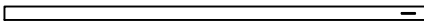
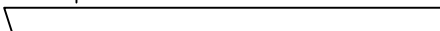
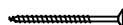



Roof plan - Dach-plan - Plan du toit - Piano del tetto - Dak plattegrond - Katuseplan











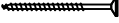
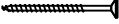
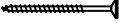
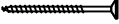
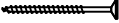
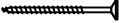
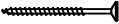
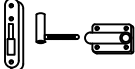
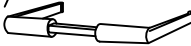

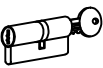
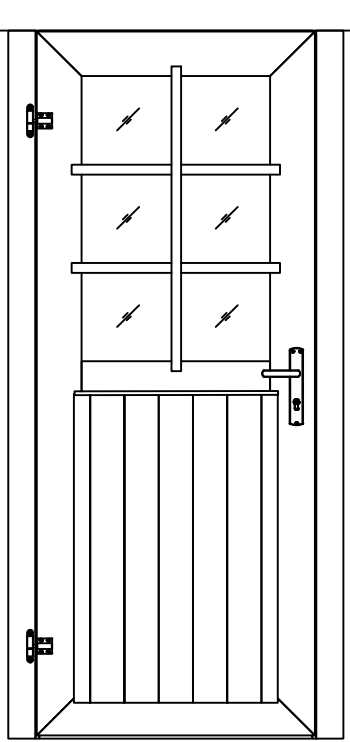
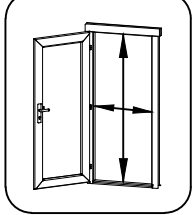



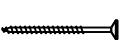

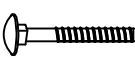
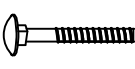
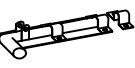

Pos	29.09.2017 Piece list - Stückliste - Liste des pièces - Elementi - Stuklijst - Tükítabel Art.Nr. 4015850 6/10	Q	P (mm)	L (mm)
001		60	40x114	800
008		2	40x114	488
009		18	40x114	4000
010		1	40x57	4015
011		1	40x57	800
012		8	40x114	4015
013		8	40x114	2217
014		2	40x114	5600
015		2	40x114	5800
016		1	40x57	5600
017		16	40x114	5600
W1-1		1		
W2-1		1		
W3-1		1		
A-PR1	Roof beam - Dachbalken - Panne de toit - Perlina del tetto - Gordingen / dakbalk - Pärlin 	5	44x140	5800
DB	Roof boards - Dachbretter - Voliges - Perlina per tetto - Dakhout - Katuselaud 	130	90x15	2500
DPL	Roofing felt fillet - Dachpappenleiste - Baguette de fixation du feutre bitumeux - Asse per fissaggio guaina bituminosa - Afdekljst asfaltpapier - Katussepapiilist 	4	15x45	2550
DPP-1	Roofing felt (strip) - Dachpappe (bahnen) - Feutre bitumeux (bande) - Cartone catramato - Asfaltpapier (baan) - Katussepapp 	6		5900
TB-1	Fascia board - Traufbrett - Bandeau de toit - Finitura lati tetto - Gevellijst - Räästalaud 	4	15x45	2550
TB-2	Fascia board - Traufbrett - Bandeau de toit - Finitura lati tetto - Gevellijst - Räästalaud 	4	15x90	2900

Pos	29.09.2017 Piece list - Stückliste - Liste des pièces - Elementi - Stuklijst - Tükítabel Art.Nr. 4015850 7/10	Q	P (mm)	L (mm)
DRV-1	Roof edge reinforcement - Dachrandverstärkung - Corniere de renfort de bord de toit - Rinforzo x tetto - Dakrand versterking - Räästatugevdus 	4	28x34	2900
KFS-1	Storm protection - Sturmleiste - Latte anti-tempete - Protezione anti vento - Stormverankering / beveiliging - Tormikinnitusliist 	4	22x45	2050
	Gable moulding - Giebelleiste - Planche de rive - Finitura per frontale e retro del tetto - Gevellijst - Viilulaud 	8	15x120	2550
HS8	Screw for gable segment - Schrauben für deckblatt - Vis pour fixation losange de finition - Viti x frontali tetto - Schroef voor gevelpunt segment - Kruvi rombile 	4	3.5x35	
HS9	Screw for gable moulding - Schrauben für giebelleiste - Vis pour fixation planche de rive - Vite per fissare finiture davanti e dietro del tetto - Schroef voor gevellijst - Kruvi viilulauale 	64	3.5x50	
HS4	Screw for fascia boards - Schrauben für traufbretter - Vis pour fixation bandeau de toit - Viti x striscia del tetto - Schroef voor gevellijst - Kruvi räästalauale 	24	3x30	
HS12	Screw for fascia boards - Schrauben für traufbretter - Vis pour fixation bandeau de toit - Viti x striscia del tetto - Schroef voor gevellijst - Kruvi räästalauale 	26	4x40	
HS12	Screw for roof edge reinforcement - Schrauben für dachrandverstärkung - Vis pour fixation corniere renfort de bord de toit - Viti x rinforzo bordo tetto - Schroef voor dakrand versterking - Kruvi räästatugevdusele 	26	4x40	
HS18	Screw for roof beams - Schrauben für dachbalken - Vis pour fixation pannes de toit - Viti per perline del tetto - Schroef voor gordingen / dakbalken - Kruvi pärlinitele 	15	5x120	
HS18	Screw for gable - Schrauben für giebel - Vis pour fixation des pignons - Viti per timpano - Schroef voor gevelpunt - Kruvi viilude kinnitamiseks 	6	5x120	
SH40	Hammer block - Schlagholz - Calle de frappe - Blocco di legno da usare come cuscinetto quando si usa il martello - Slagklos - Löögiklots 	1		
SFS	Nut for storm protection - Schraubenmutter für sturmleiste - Ecrou pour latte anti-tempete - Dado x asta protezione vento - Moer voor stormverankering - Mutter tormikinnitusliistule 	8	D6	
NF4	Zn nail for roof - Zn nägel für dachbretter - Pointe pour fixation voliges de toit - Chiodi x perline tetto - Spijker(nagel) voor dakhout - Nael katuselauale 	540	2x50	
NF5	Zn nail for roofing felt fillet - Zn nägel für dachpappenleiste - Pointe pour baguette de fixation feutre bitumeux - Chiodi x carta bituminosa x tetto - Spijker(nagel) voor asfaltpapier afdekljst - Papiliistunael 	20	2x40	
NF6	Roofing nails for roofing felt - Nägel für dachpappe - Pointe pour fixation feutre bitumeux - Chiodi per cartone catramato - Asfaltnagel - Papinael 	280	2.8x15	
BFS	Bolt for storm protection - Bolzen für sturmleiste - Boulon pour latte anti-tempete - Bullone x asta protezione vento - Bout voor stormankerlat - Puidupolt tormikinnitusliistule 	8	6x60	
GS	Gable segment - Deckblatt - Losange de finition - Decorazione in legno x frontale tetto - Gevelpunt segment - Romb 	2		
DFS	Washer for storm protection - Dichtscheibe für sturmleiste - Rondelle pour latte anti-tempete - Rondella x asta protezione vento - Afdichtring voor storm strip - Seib tormikinnitusliistule 	8	D6	
	Window - Fenster - Fenetre - Finestra - Raam - Aken AK.1.106.SSV.j SGC	1		
	Door - Tür - Porte - Porte - Deur - Uks TUL.2.100.IVP TC	1		
	Door - Tür - Porte - Porte - Deur - Uks UK.2.056.SVV.MMX40 SGA+28	1		

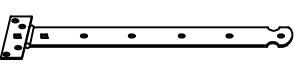
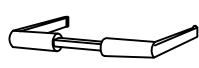
Pos	29.09.2017 Piece list - Stückliste - Liste des pièces - Elementi - Stuklijst - Tükítabel 775x1850 UK.2.056.SVV.MMX40 SGA+28 8/10	Q	P (mm)	L (mm)
HS1	Screw for georgian bars - Schraube für sprossen - Vis pour croisillons - Viti per unire la griglia georgiana della finestra - Schroeven voor raamverdeling - Kruvi ukse peffeliistule 	6	2.5x20	
HS9	Screw for fixing door to the wall - Schraube zur befestigung für - zarge mit wand - Vis de fixation partie basse dormants de porte au 1er rang de madrier - Viti per fissare la porta alla parete - Schroef voor bevestiging deur naar wand - Kruvi ukse selengi kinnifamiseks seinale 	2	3.5x50	
HS11	Screw for fixing bolt hinge - Schraube für türband - Vis pour fixation gonds de porte - pour ouvrant - Viti per fissaggio cardini e cerniere della porta - Schroef voor scharnier - Kruvi ukse polthingele 	8	4x30	
HS12	Screw for fixing bolt hinge - Schraube für türband - Vis pour fixation gonds de porte - pour ouvrant - Viti per fissaggio cardini e cerniere della porta - Schroef voor scharnier - Kruvi ukse polthingele 	6	4x40	
HS13	Screw for door jamb - Schraube für türrahmen - Vis de fixation partie haute avec montants du cadre de porte - Viti x fissaggio montanti porte - Schroef voor deurkozijn - Kruvi ukse lengile 	2	4x60	
HS16	Screw for door jamb - Schraube für türrahmen - Vis de fixation partie haute avec montants du cadre de porte - Viti x fissaggio montanti porte - Schroef voor deurkozijn - Kruvi ukse lengile 	2	5x90	
HS25	Screw for doorstep - Schrauben für swelle - Vis pour fixation barre de seuil - Vite per soglia della porta - Schroef voor deurdorpel - Kruvi lävepakule 	2	4.5x65	
	Male bolt hinge for door - Türband - Partie male de paumelle de porte - Cerniera anube x porta - Scharnier bout - Polthing adapteriga DIN15-57 	2		
TL4	Door handle fittings - Türgriff - Poignée de porte - Maniglie - Deurhendel / klink - Ukse käepide 	1		
TL5	Set of door lock covers - Schlossblenden - Set de garnitures de porte - Copertura serrature - Slot sluitplaat set - Ukse lukuplaat 	1		
	Cylinder lock - Zylinderschloss - Barillet de porte - Serratura - Cylinder slot - Ukse lukusüdamik 	1	30x30	
Glass size - Glasgröße - Taille de la vitre - Misura del vetro - Glas afmeting - Klaasi mõõt: 502x750 mm		  <p>702x1793 mm</p>		

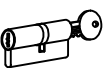
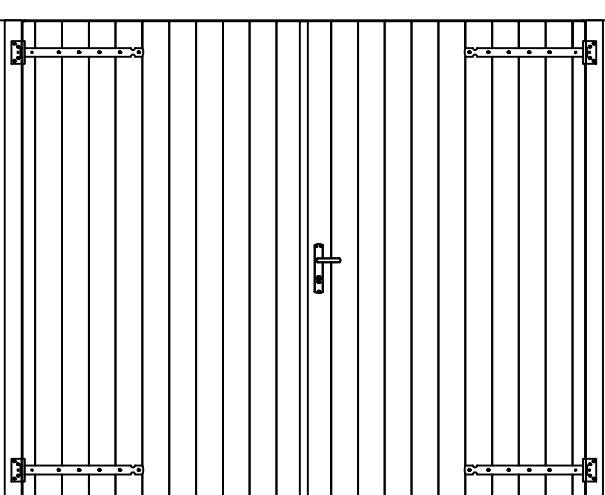
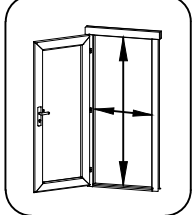

Pos	29.09.2017	Piece list - Stückliste - Liste des pièces - Elementi - Stuklijst - Joonis 2390x2020 TUL.2.100.IVP.TC	9/10	Q	P (mm)	L (mm)
HS9	Screw for fixing door to the wall - Schraube zur Befestigung für - zarge mit wand - Vis de fixation partie basse dormantis de porte au 1er rang de madrier - Viti per fissare la porta alla parete - Schroef voor bevestiging deur naar wand - Kruvi ukseleingi kinnitamiseks seinale		4	3.5x50		
HS4	Screw for door fillet - Schraube zur Befestigung türleiste - Vis pour fixation baguette d'arret de porte - Viti per massellino della porta - Schroef voor deurlijst - Kruvi ukse kokkuvaltšiliistule		6	3x30		
HS10	Screw for latch bolt for gate - Schraube für doppeltürfeststellriegel - Vis de fixation des loquets de fermeture pour porte double vantaux - Vite per il fermo della porta - Schroef voor dubbele deur vergrendelingsbout - Kruvi riivile		12	4x25		
HS12	Screw for latch answer - Schraube für einrasten antwort - Vis pour fixation partie reception loquet haut de porte - Contro vite per il fermo - Schroef tbv vergrendeling - Kruvi riivi vastusele		2	4x40		
HS16	Screw for door jamb - Schraube für türrahmen - Vis de fixation partie haute avec montants du cadre de porte - Viti x fissaggio montanti porte - Schroef voor deurkozijn - Kruvi ukse lengile		2	5x90		
HS19	Screw for gate hinges - Schrauben für torriegel - Vis pour fixation charniere de porte - Viti per cerniere del cancello - Schroef voor poort scharnier - Kruvi T-hingedele		36	6x40		
SFS	Nut for gate hinges - Schraubenmutter für torriegel - Ecrou pour les charniere de porte - Dado per cerniere delle porte - Moer voor poort scharnier - Mutter T-hingele		8	D6		
BFS	Bolt for gate hinges - Bolzen für torriegel - Boulon pour charniere de porte - Bullone per cerniere di porte - Scharnier bout - Puidupolt T-hingele		4	6x100		
BFS	Bolt for gate hinges - Bolzen für torriegel - Boulon pour charniere de porte - Bullone per cerniere di porte - Scharnier bout - Puidupolt T-hingele		4	6x60		
TL	Latch bolt for double door - Türriegel - Loquet pour double porte - Scrocco per porta doppia - Nachtslot - Riiv		2			
	Latch answer - Einrasten antwort - Partie de reception du loquet haut de porte - Contro fermo della chiusura della porta - Sluitbeugel plaatgrendel - Riivi vastus		1			
	Washer for gate hinges - Dichtscheibe für torriegel - Rondelle pour charniere de porte - Rondella per cerniera della porta - Afdichtring voor poortscharnier - Seib T-hingele		8	D6		
	Door hinges - Torriegel - Charniere de porte - Cerniere - Deur scharnier - T-hing		4			
TL4	Door handle fittings - Türgriff - Poignée de porte - Maniglie - Deurhendel /klink - Ukse käepide		1			
TL5	Set of door lock covers - Schlossblenden - Set de garnitures de porte - Copertura serrature - Slot sluitplaat set - Ukse lukuplaat		1			
	Cylinder lock - Zylinderschloss - Barillet de porte - Serratura - Cylinder slot - Ukse lukusüdamik		1	30x40		
				 2290x1970		

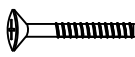
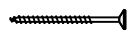
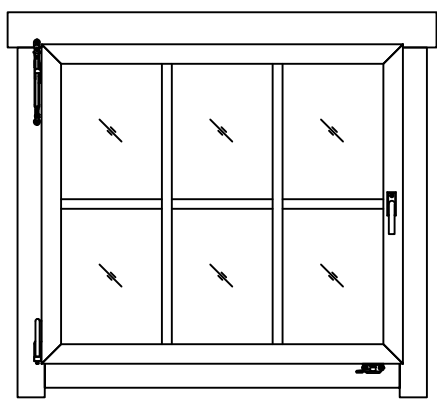
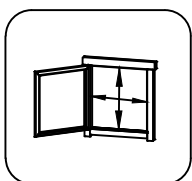
Pos	29.09.2017 Piece list - Stückliste - Liste des pièces - Elementi - Stuklijst - Joonis 10/10 990x882 AK.1.106.SSV.j SGC	Q	P (mm)	L (mm)
FS1	Window handle fittings - Fenstergriff - Poignee de fenetre - Maniglia c/ferramenta - Raamhendel -/grendel -/klink - Aknalink 	1		
FSP	Bolt for window handle fittings - Bolzen für fenstergriff beschlag - Vis pour fixation poignee de fenetre - Bullone x apertura manuale finestra - Schroef voor raamhendel - Akna käepideme polt 	2		
HS1	Screw for georgian bars - Schraube für sprossen - Vis pour croisillons - Viti per unire la griglia georgiana della finestra - Schroeven voor raamverdeling - Krugi akna petteliistule 	6	2.5x20	
<p data-bbox="255 414 1284 459">Glass size - Glasgröße - Taille de la vitre - Misura del vetro - Glas afmeting - Klaasi mõõt: 846x738 mm</p>   <p data-bbox="1364 604 1492 649">890x782 mm</p>				