

Art. Nr. 2810550

1/6

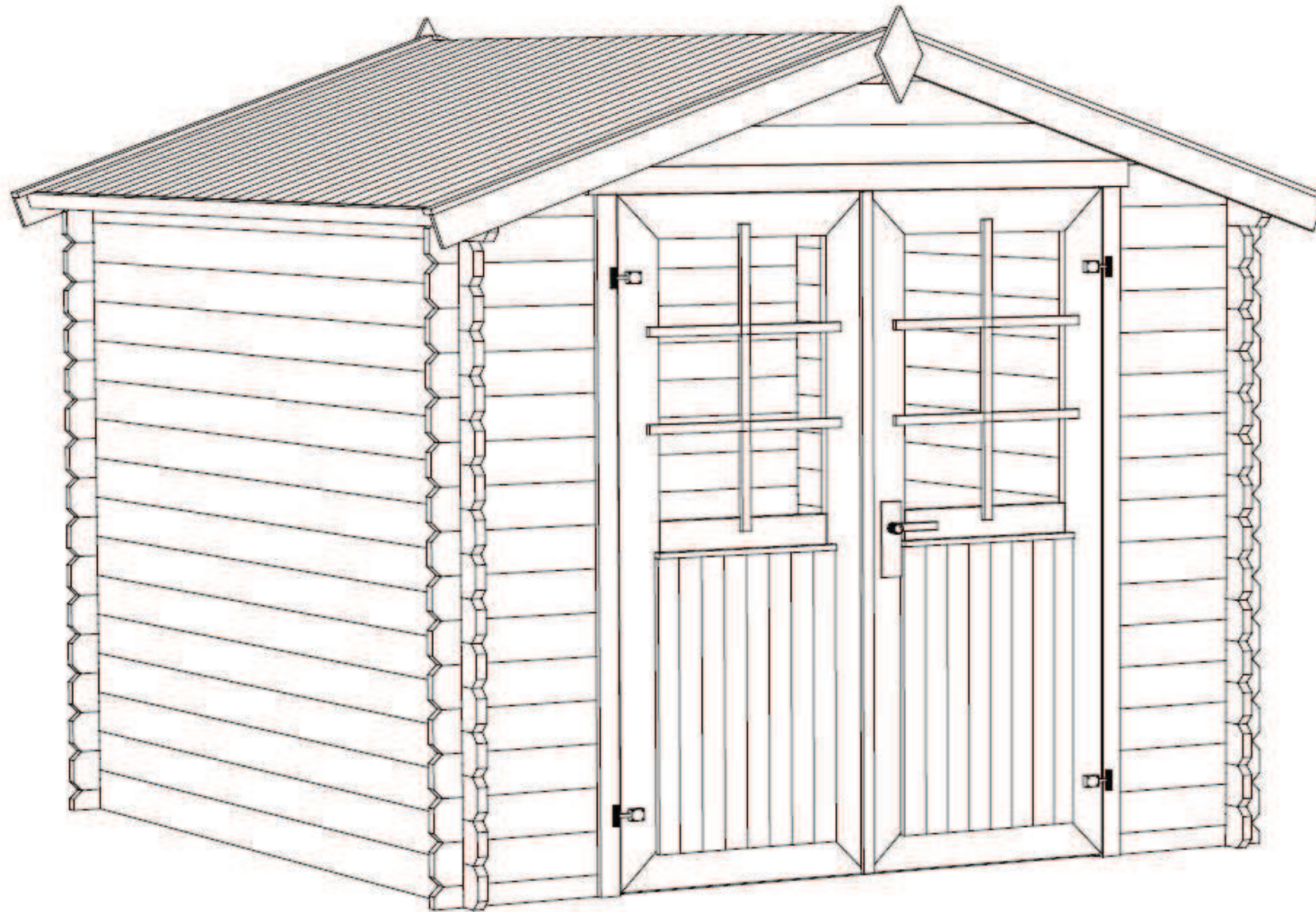

09.01.2014

Art.Nr. 2810550

GROUNDPLAN - GRUNDPLAN - PLAN DE MASSE

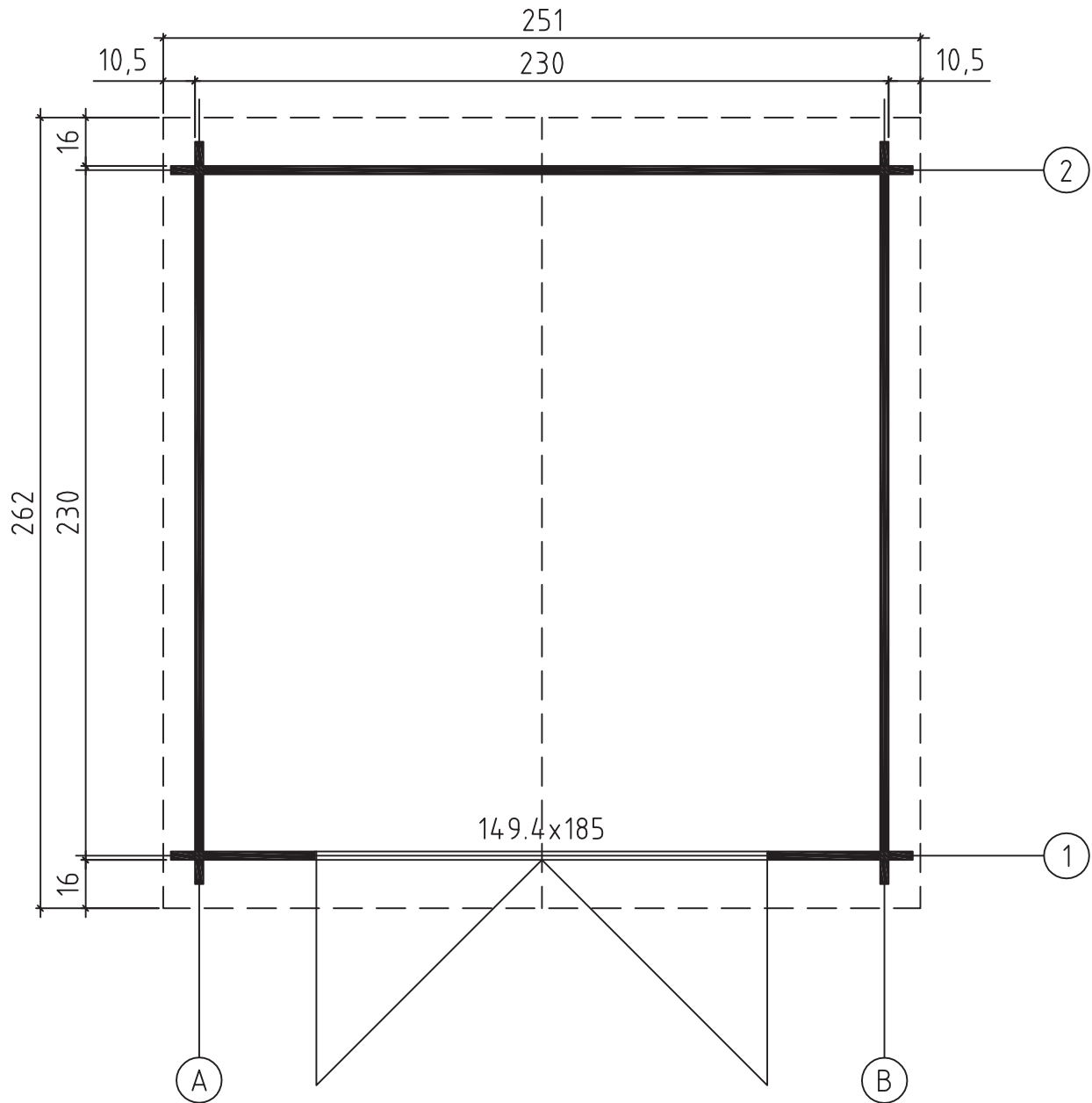

Art.Nr. 2810550

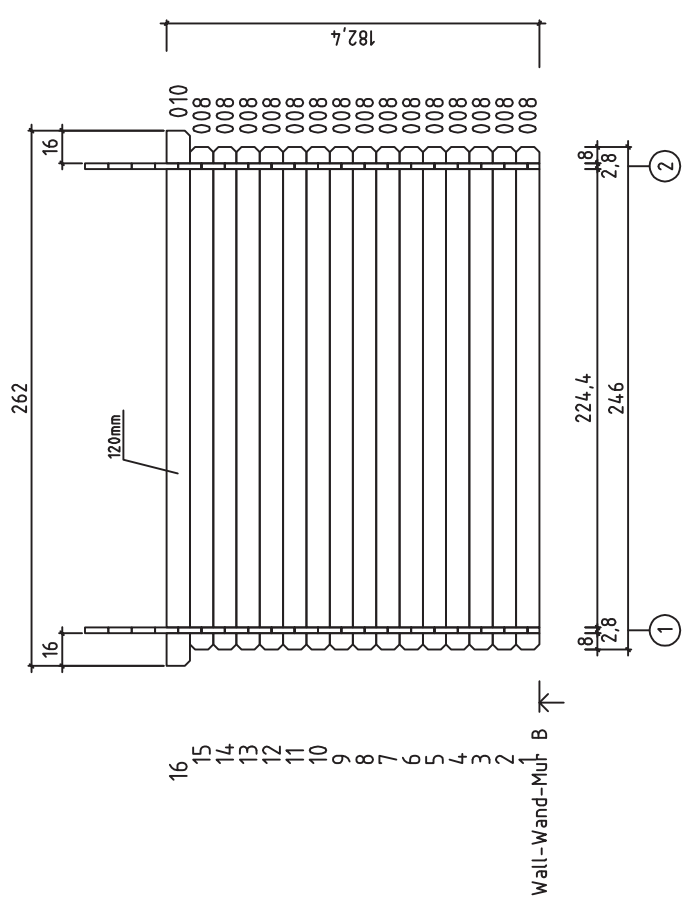
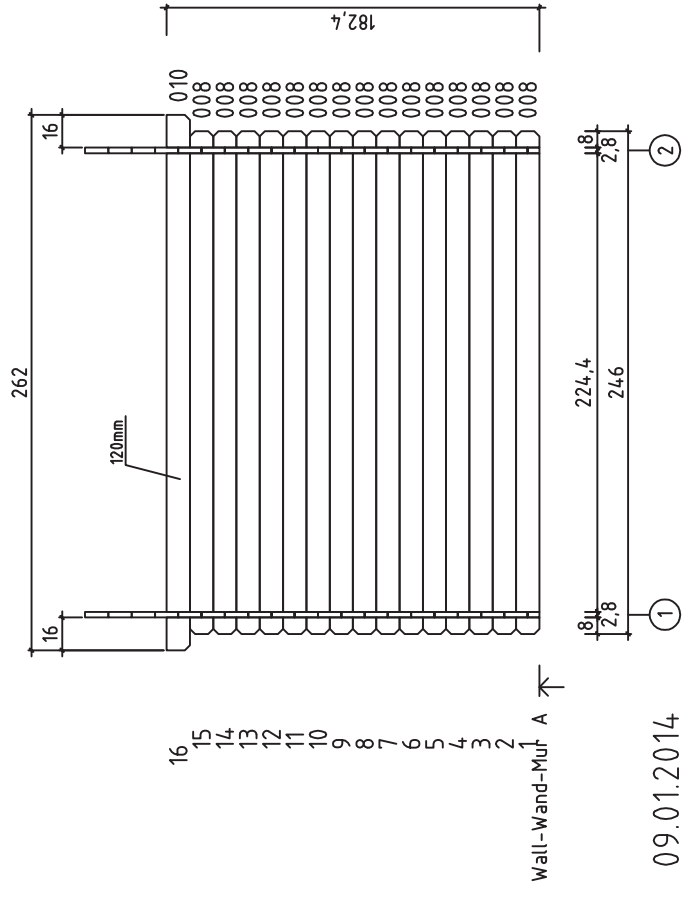
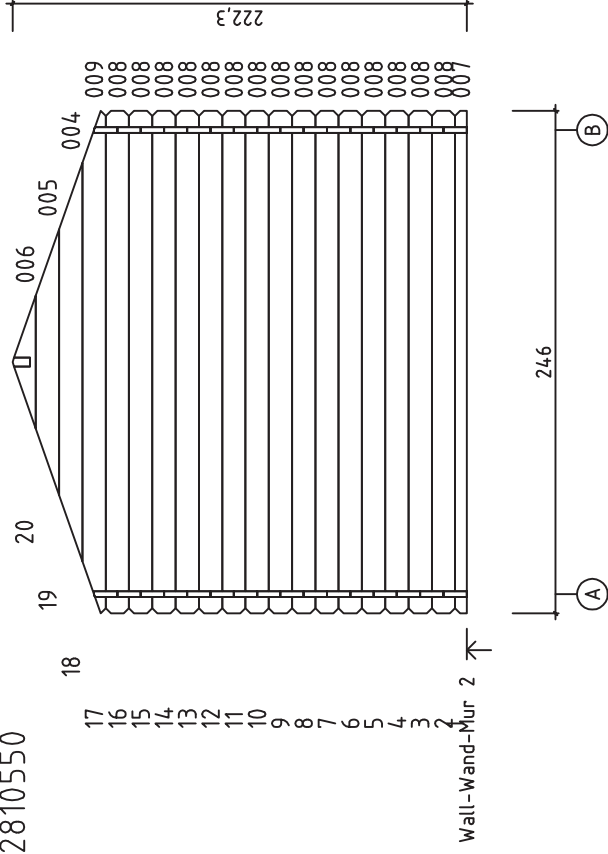
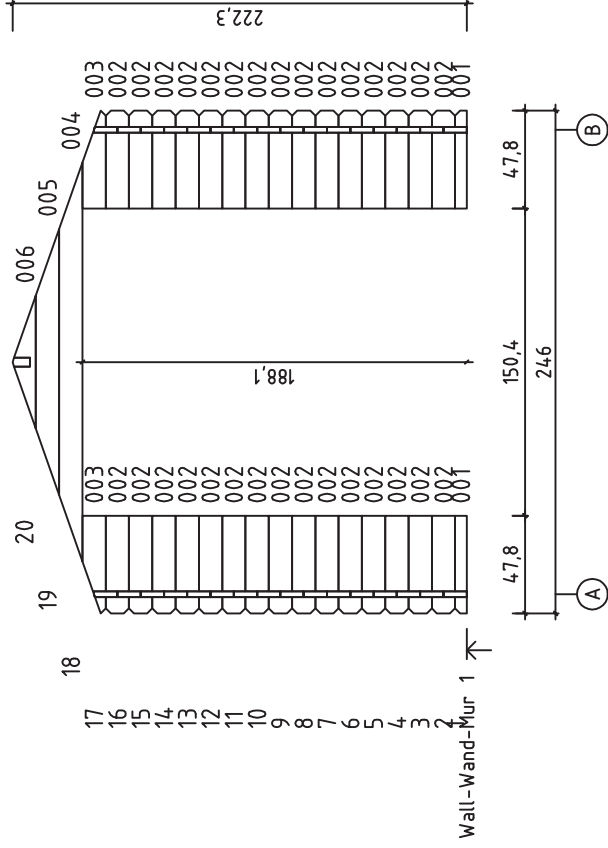

09.01.2014



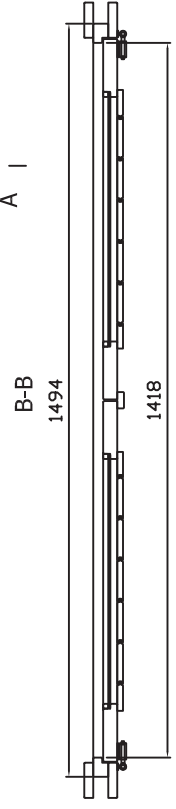
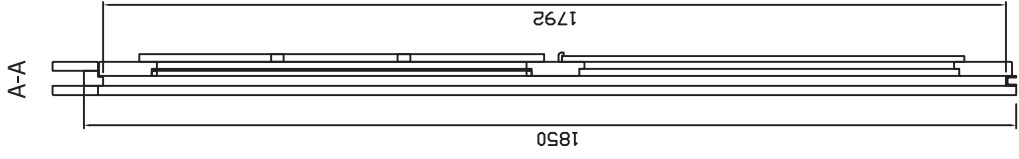
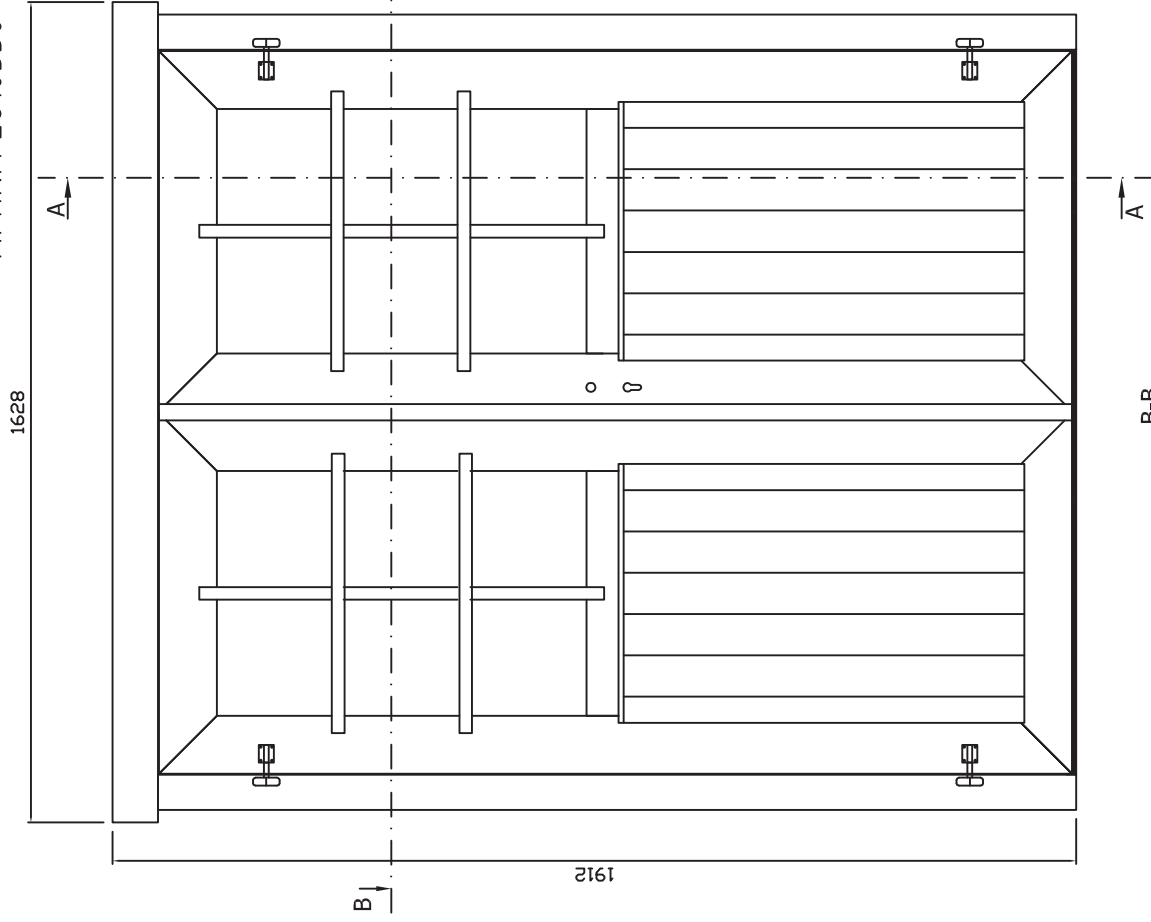









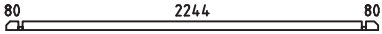
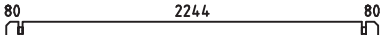
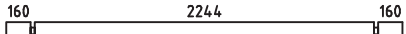
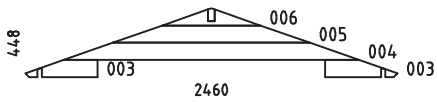
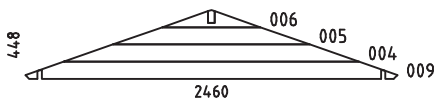
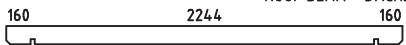

Art.Nr. 2810550

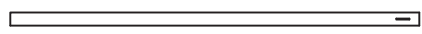
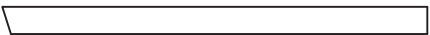











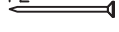

Door glass size - Glasgröße - Taille de la vitre:
502x750 mm

09.01.2014

4/6

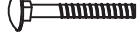
Pos	09.01.2014	Piecelist - Stücklist - Liste des composants Art.Nr. 2810550	5/6	Q.	P. (mm)	L. (mm)
001				2	28x57	478
002				30	28x114	478
007				1	28x57	2460
008				45	28x114	2460
010				2	28x120	2620
W1-1				1		
W2-1				1		
PR1		ROOF BEAM - DACHBALKEN - PANNE DE TOIT		1	44x120	2620
	ROOF BOARDS - DACHBRETTER - VOLIGES			60	90x15	1330
	ROOFING FELT FILLET - DACHPAPPENLEISTE - BAGUETTE DE FIXATION DU FEUTRE BITUMEUX			4	15x45	1380
DPP	ROOFING FELT - DACHPAPPE - FEUTRE BITUMEUX			3		2720
	EAVES BOARD - TRAUFBRETT - BANDEAU DE TOIT			2	15x45	2620
	STORM PROTECTION - STURMLEISTE LATTE ANTI-TEMPETE			4	22x45	1760
	GABLE MOULDING - GIBELLEISTE PLANCHE DE RIVE			4	15x90	1380
HS12	SCREW FOR GABLE SEGMENT - SCHRAUBEN FÜR DECKBLATT - VIS POUR FIXATION LOSANGE DE FINITION			4	3.5x35	
	SCREW FOR GEORGIAN BARS - SCHRAUBE FÜR SPROSSEN - VIS DE BARRES GEORGIANNE			12	2.5x20	
HS16	SCREW FOR GABLE MOULDING - SCHRAUBEN FÜR GIBELLEISTE - VIS DE FIXATION POUR PLANCHE DE RIVE			16	3.5x50	
HS3	SCREW FOR DOOR FILLET - SCHRAUBE ZUR BEFESTIGUNG TÜRLEISTE - VIS D'ASSEMBLAGE DU CADRE DE PORTE			5	3x30	
HS59	SCREW FOR DOORSTEP - SCHRAUBEN FÜR SWELLE - VIS DE FIXATION DU SEUIL DE PORTE			3	4.5x65	
HS56	SCREW FOR FIXING BOLT HINGE - SCHRAUBE FÜR TÜRRIGEL - VIS DE FIXATION POUR CHARNIERES ET GONDS DE PORTE			16	4x30	
HS58	SCREW FOR FIXING BOLT HINGE - SCHRAUBE FÜR TÜRRIGEL - VIS DE FIXATION POUR CHARNIERES ET GONDS DE PORTE			12	4x40	
HS32	SCREW FOR EAVES BOARDS - SCHRAUBEN FÜR TRAUFBRETTER - VIS DE FIXATION POUR BANDEAU DE TOIT			12	4x40	
	MALE BOLT HINGE FOR DOOR - TÜRRIGEL - PARTIE MALE DE CHARNIERE DE PORTE			4		

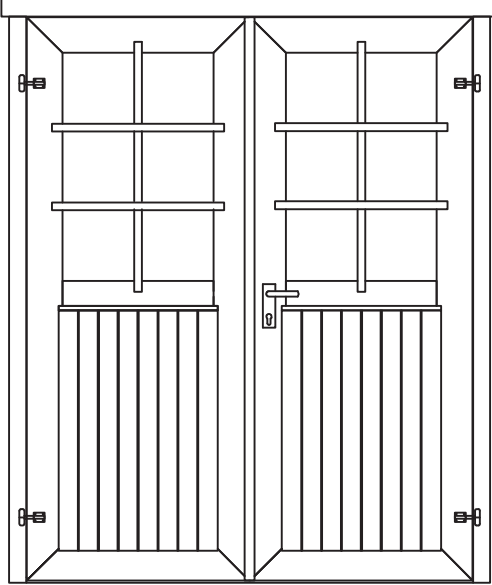
Pos	09.01.2014	Piecelist - Stücklist - Liste des composants Art.Nr. 2810550	6/6	Q.	P. (mm)	L. (mm)
HS22	SCREW FOR FIXING DOOR TO THE WALL - SCHRAUBE ZUR BEFESTIGUNG TÜR - ZARGE MIT WAND - VIS DE FIXATION DORMANT DE PORTE			2	3.5x50	
HS41	SCREW FOR DOOR JAMB - SCHRAUBE FÜR TÜRRAHMEN - VIS DE FIXATION POUR MONTANT DE PORTE			2	5x90	
TL5	DOOR LOCK COVER - SCHLOSSBLENDE - GARNITURE DE SERRURE DE PORTE			1		
SH28	HAMMER BLOCK - SCHLAGHOLZ - CALLE DE FRAPPE 28mm			1		
NFD	ZN NAIL FOR ROOFING FELT FILLET - ZN NÄGEL FÜR DACHPAPPENLEISTE - - POINTE POUR BAGUETTE FIXATION FEUTRE BITUMEUX			16	2x40	
NF	ROOFING NAILS FOR ROOFING FELT - NÄGEL FÜR DACHPAPPE - POINTE DE FIXATION POUR FEUTRE BITUMEUX			76	2.8x15	
TL4	DOOR HANDLE FITTINGS-TÜRGRIFF - SET DE GARNITURES DE SERRURE DE PORTE			1		
	CYLINDER - ZYLINDERSCHLOSS - CYLINDRE DE SERRURE			1	30x30	
TL	LATCH BOLT FÜR DOUBLE DOOR - TORRIEGEL - LOQUET POUR DOUBLE PORTE			2		
GS	GABLE SEGMENT-DECKBLATT - LOSANGE DE FINITION			2		
SFS	NUT FOR STORM PROTECTION - SCHRAUBENMUTTER FÜR STURMLEISTE - ÉCROU POUR LAME ANTI-TEMPETE			8	D6	
BFS	BOLT FOR STORM PROTECTION - BOLZEN FÜR STURMLEISTE - VIS POUR LAME ANTI-TEMPETE			8	6x60	
DFS	WASHER FOR STORM PROTECTION - DICHTSCHEIBE FÜR STURMLEISTE - RONDELLE POUR LAME ANTI-TEMPETE			8	D6	
NF2	ZN NAIL FOR ROOF - ZN NÄGEL FÜR DACHBRETTER - POINTE POUR TOIT			128	2x50	
	DOOR - TÜR - PORTE 14.94x1850 SGA	TUK.2.056.SVP.MMX28		1		
						

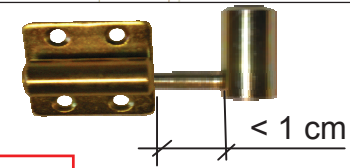
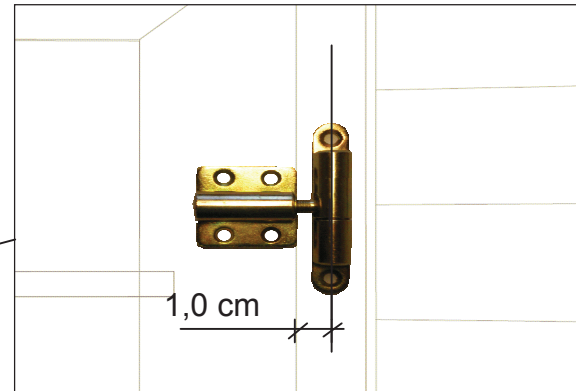
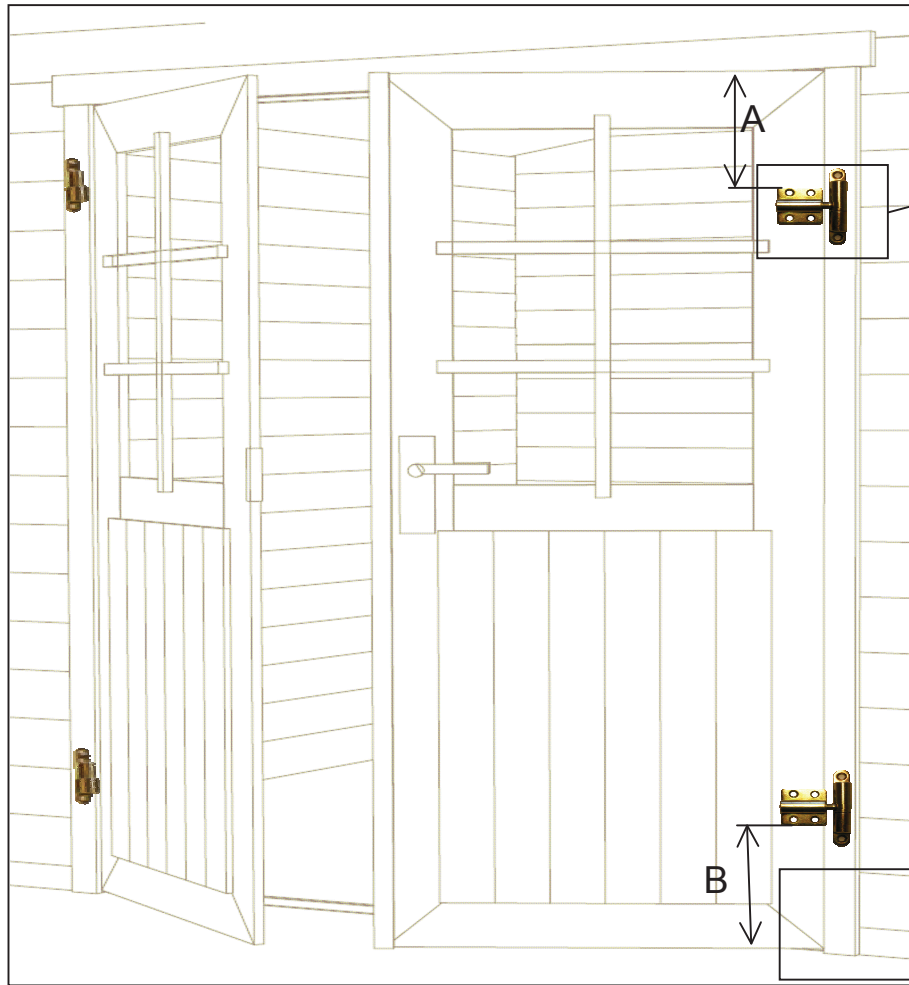

A=B= 210mm

