

Art. Nr. 2824650
1/7

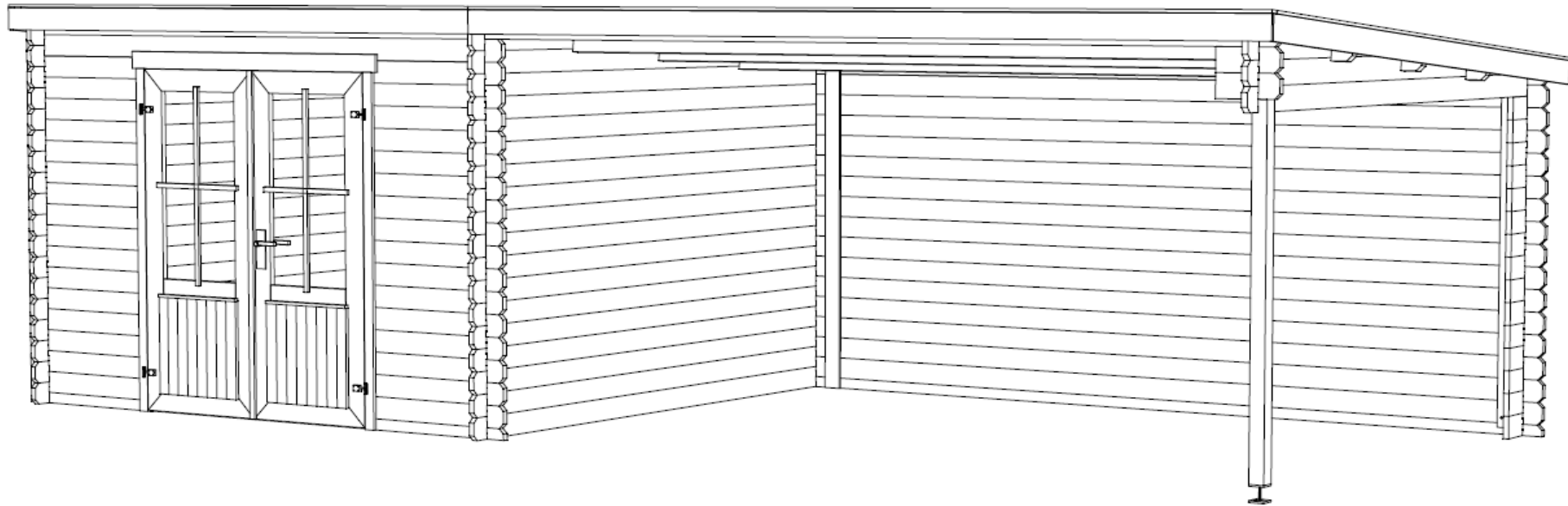

26.10.2015





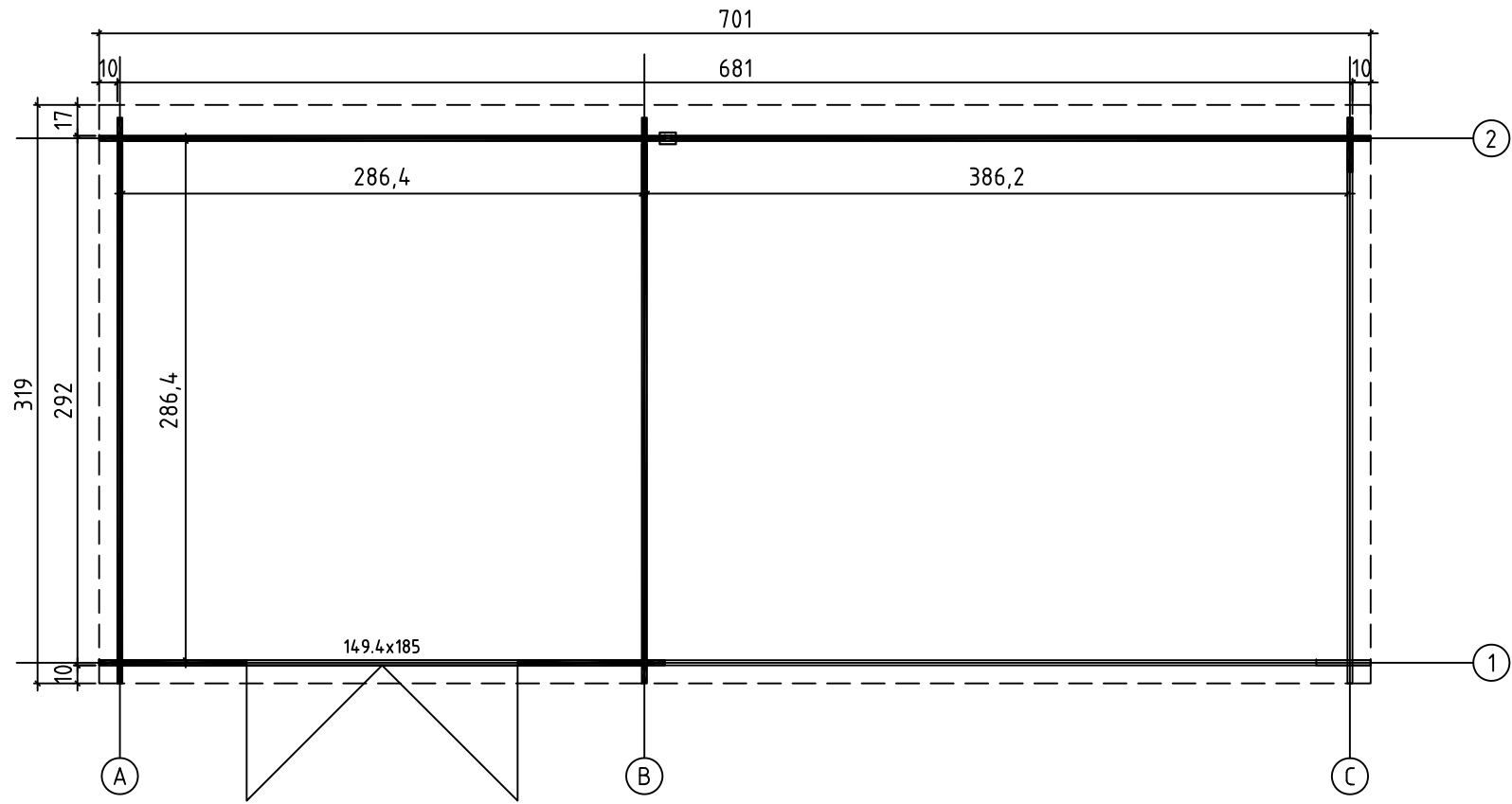

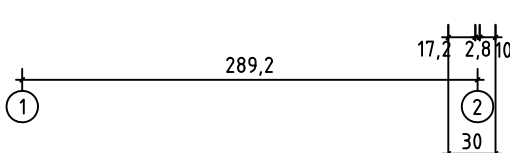
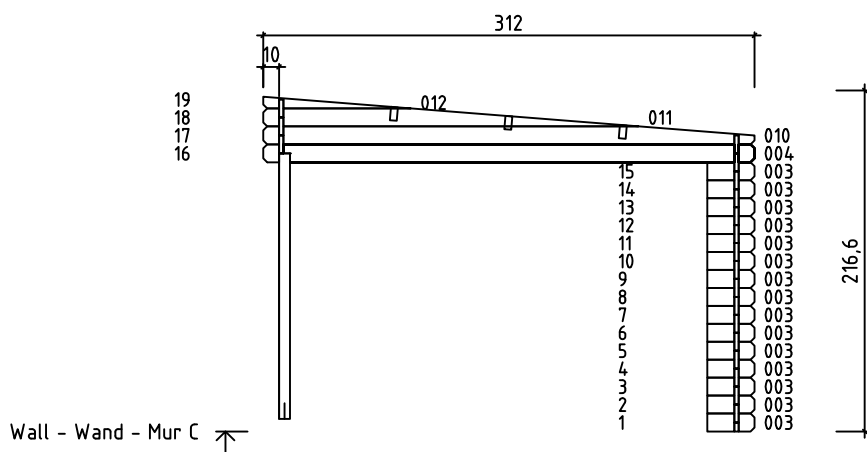
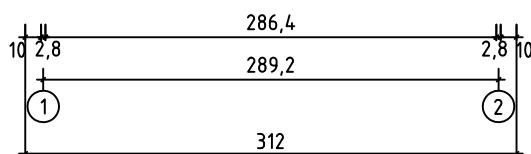
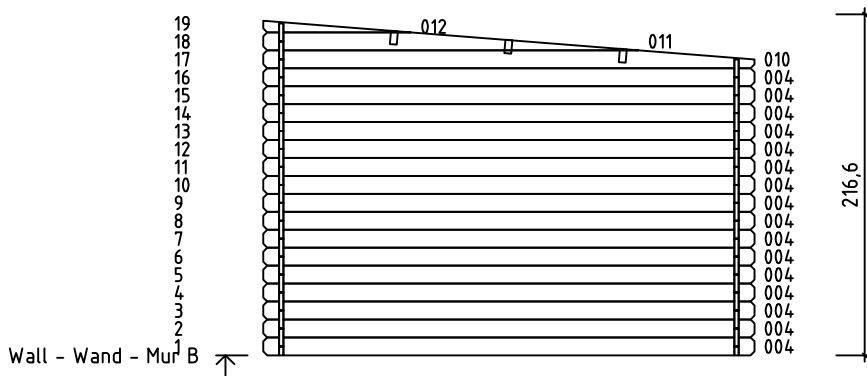
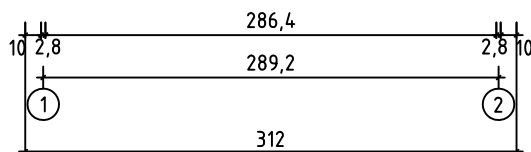
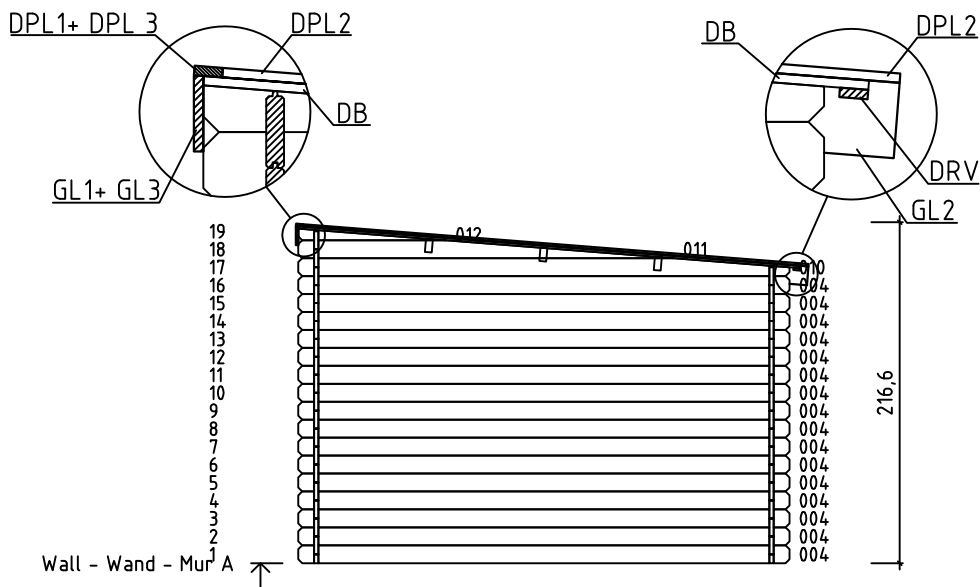



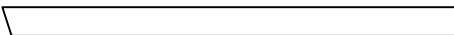
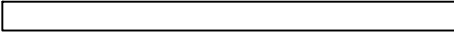
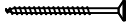
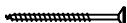



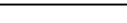
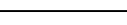



Art.nr. 2824650



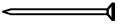

GROUNDPLAN - GRUNDPLAN - PLAN DE MASSE

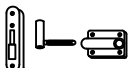
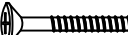



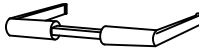

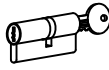

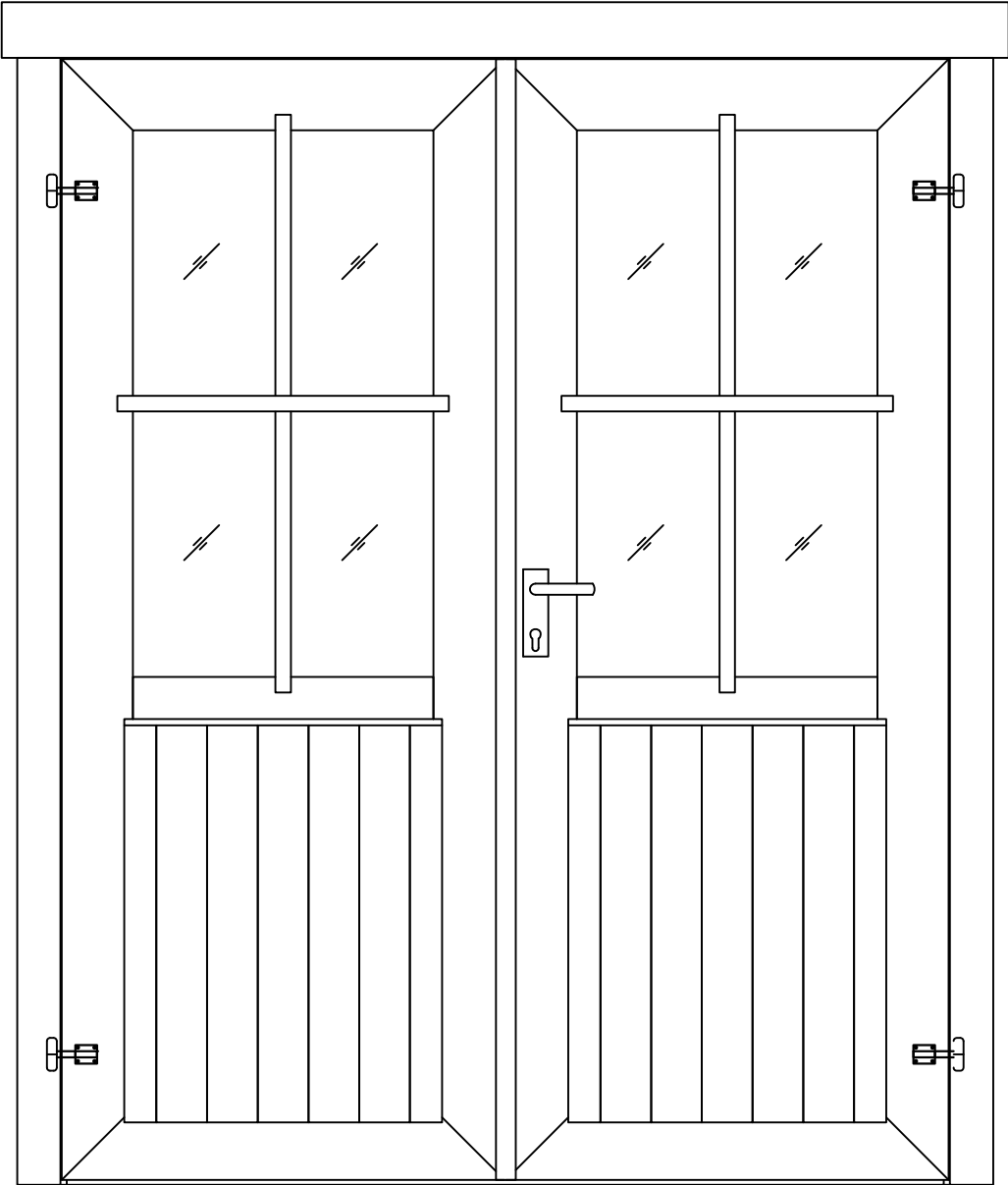
Pos	26.10.2015	Piece list - Stückliste - Liste des pièces Art.nr. 2824650	5/7	Q.	P (mm)	L (mm)
001				2	28x57	808
002				32	28x114	808
003				17	28x114	300
004				49	28x114	3120
005				2	28x114	3006
006				2	28x114	4004
007				1	28x57	3120
008				1	28x57	3856
009				15	28x114	3856
WA-1				1		
WB-1				1		
WC-1				1		
A-PR2				3	44x140	4004
A-PR1		ROOF BEAM - DACHBALKEN - PANNE DE TOIT		3	44x140	3006
DB	ROOF BOARDS - DACHBRETTER - VOLIGES			78	90x15	3200
	H-PROFILE - WANDVERBINDUNG - PROFILE H			1	58x90	1820
DPL1	ROOFING FELT FILLET - DACHPAPPENLEISTE - BAGUETTE DE FIXATION DU FEUTRE BITUMEUX			1	15x45	3021
DPL2	ROOFING FELT FILLET - DACHPAPPENLEISTE - BAGUETTE DE FIXATION DU FEUTRE BITUMEUX			2	15x45	3220
DPL3	ROOFING FELT FILLET - DACHPAPPENLEISTE - BAGUETTE DE FIXATION DU FEUTRE BITUMEUX			1	15x45	4019
	ROOFING FELT (STRIP) - DACHPAPPE (BAHNEN) - FEUTRE BITUMEUX (BANDE)			4		7110
P	POST - PFOSTEN - POTEAU			1	70x70	1687
DRV	ROOF EDGE REINFORCEMENT - DACHRANDVERSTÄRKUNG - CORNIERE DE RENFORT DE BORD DE TOIT			2	15x45	3505
	STORM PROTECTION - STURMLEISTE - LATTE ANTI-TEMPETE			3	22x45	1800
	STORM PROTECTION - STURMLEISTE - LATTE ANTI-TEMPETE			2	22x45	2000
GL1	GABLE MOULDING - GIEBELLEISTE - PLANCHE DE RIVE			1	15x120	3021

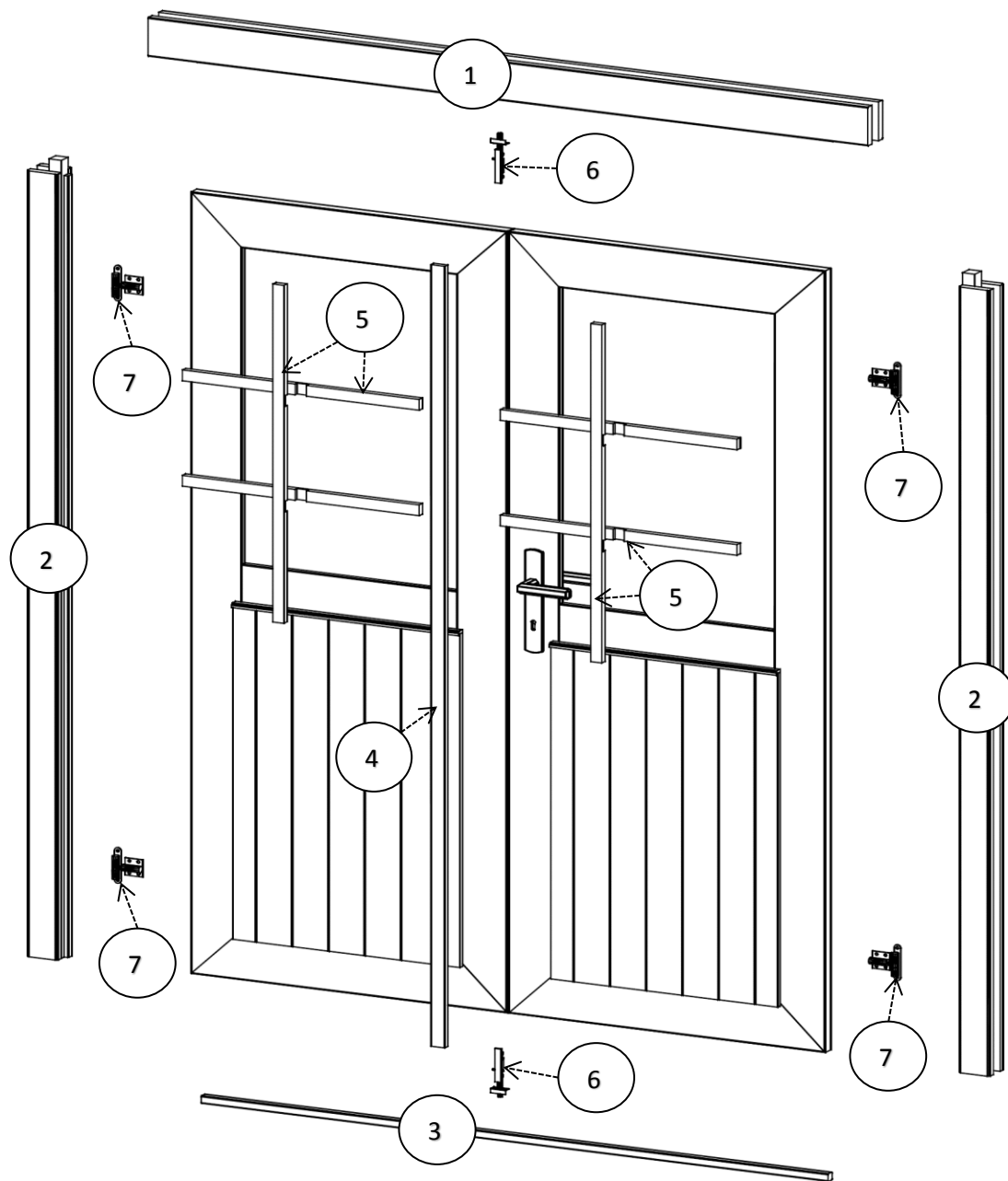
Pos	26.10.2015	Piece list - Stückliste - Liste des pièces Art.nr. 2824650	6/7	Q.	P (mm)	L (mm)
GL2	GABLE MOULDING - GIEBELLEISTE - PLANCHE DE RIVE			2	15x120	3250
GL3	GABLE MOULDING - GIEBELLEISTE - PLANCHE DE RIVE			1	15x120	4019
	SCREW FOR GEORGIAN BARS - SCHRAUBE FÜR SPROSSEN - VIS DE BARRES GEORGIENNE			8	2.5x20	
	SCREW FOR FIXING DOOR TO THE WALL - SCHRAUBE ZUR BEFESTIGUNG TÜR - ZARGE MIT WAND - VIS DE FIXATION DORMANT DE PORTE			2	3.5x50	
	SCREW FOR GABLE MOULDING - SCHRAUBEN FÜR GIEBELLEISTE - VIS DE FIXATION POUR PLANCHE DE RIVE			38	3.5x50	
	SCREW FOR POST - SCHRAUBEN FÜR PFOSTEN - VIS DE FIXATION DES POTEAUX			2	3.5x50	
	SCREW FOR DOORSTEP - SCHRAUBEN FÜR SWELLE - VIS DE FIXATION DU SEUIL DE PORTE			3	3x30	
	SCREW FOR ROOF EDGE REINFORCEMENT - SCHRAUBEN FÜR DACHRANDVERSTÄRKUNG - VIS POUR RENFORT DE BORD DE TOIT			16	3x30	
	SCREW FOR DOOR FILLET - SCHRAUBE ZUR BEFESTIGUNG TÜRLEISTE - VIS D'ASSEMBLAGE DU CADRE DE PORTE			5	3x30	
	SCREW FOR FIXING BOLT HINGE - SCHRAUBE FÜR TÜRRIEDEL - VIS DE FIXATION POUR CHARNIERES ET GONDS DE PORTE			16	4x30	
	SCREW FOR FIXING BOLT HINGE - SCHRAUBE FÜR TÜRRIEDEL - VIS DE FIXATION POUR CHARNIERES ET GONDS DE PORTE			12	4x40	
HS99	SCREWS FOR WALL MOUNTING - SCHRAUBEN FÜR WANDMONTAGE - VIS DE FIXATION AU MUR			1	4x60	
	SCREW FOR DOOR JAMB - SCHRAUBE FÜR TÜRRAHMEN - VIS DE FIXATION POUR MONTANT DE PORTE			2	4x60	
HS43	SCREW FOR ROOF BEAMS - SCHRAUBEN FÜR DACHBALKEN - VIS POUR PANNE DE TOIT			20	5x120	
	SCREW FOR DOOR JAMB - SCHRAUBE FÜR TÜRRAHMEN - VIS DE FIXATION POUR MONTANT DE PORTE			2	5x90	
	SCREW FOR POST HEIGHT ADJUSTMENT - SCHRAUBEN FÜR REGULIERUNGSSCHRAUBE FÜR PFOSTEN - VIS DE FIXATION DE SUPPORT RÉGLABLE DE POTEAU			8	6x50	
	HAMMER BLOCK - SCHLAGHOLZ - CALLE DE FRAPPE			1		
	NUT FOR STORM PROTECTION - SCHRAUBENMUTTER FÜR STURMLEISTE - ÉCROU POUR LAME ANTI-TEMPETE			10		
	NUT FOR POST HEIGHT ADJUSTMENT - MUTTER FÜR REGULIERUNGSSCHRAUBE - ÉCROU POUR SUPPORT RÉGLABLE DE POTEAU			1		
	ZN NAIL FOR ROOF - ZN NÄGEL FÜR DACHBRETTER - POINTES DE FIXATIONS DES VOLIGES DE TOIT			418	2x50	
	ZN NAIL FOR ROOFING FELT FILLET - ZN NÄGEL FÜR DACHPAPPENLEISTE - POINTE POUR BAGUETTE FIXATION FEUTRE BITUMEUX			32	2x40	
	ROOFING NAILS FOR ROOFING FELT - NÄGEL FÜR DACHPAPPE - POINTE DE FIXATION POUR FEUTRE BITUMEUX			250	2.8x15	
	MALE BOLT HINGE FOR DOOR - TÜRRIEGEL - PARTIE MALE DE CHARNIERE DE PORTE			4		
	BOLT FOR STORM PROTECTION - BOLZEN FÜR STURMLEISTE - VIS POUR LAME ANTI-TEMPETE			10		
	LATCH BOLT FOR DOUBLE DOOR - TORRIEGEL - LOQUET POUR DOUBLE PORTE			2		

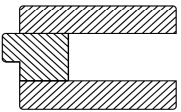
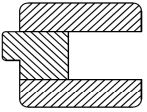
Pos	26.10.2015	Piece list - Stückliste - Liste des pièces Art.nr. 2824650	7/7	Q.	P (mm)	L (mm)
		WASHER FOR STORM PROTECTION - DICHTSCHEIBE FÜR STURMLEISTE - RONDELLE POUR LAME ANTI-TEMPETE		10		
TL4		DOOR HANDLE FITTINGS - TÜRGRIFF - SET DE GARNITURES DE SERRURE DE PORTE		1		
TL5		SET OF DOOR LOCK COVERS - SCHLOSSBLENDEN - SET DE GARNITURES DE SERRURE DE PORTE		1		
		CYLINDER LOCK - ZYLINDERSCHLOSS - CYLINDRE DE SERRURE		1		
		POST HEIGHT ADJUSTMENT - REGULIERUNGSSCHRAUBE FÜR PFOSTEN - SUPPORT RÉGLABLE DE POTEAU		1		
		DOOR - TÜR - PORTE 1494x1850	TUK.2.044.SVP.MX28	SGA+28	1	
						

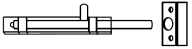
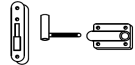

Pos	Piece list - Stückliste - Liste des pièces	Q.	P (mm)
1		1	66x100
2		2	66x80
3		1	18x18
4		1	13x32
5		6	15x25
6		2	
7		4	

