

Kenzo 300
Art. Nr. 3415500
1/9



07.11.2017

Art. Nr. 3415500

Groundplan - Grundplan - Plan de masse - Planimetria -
Plattegrond - Põhiplaan

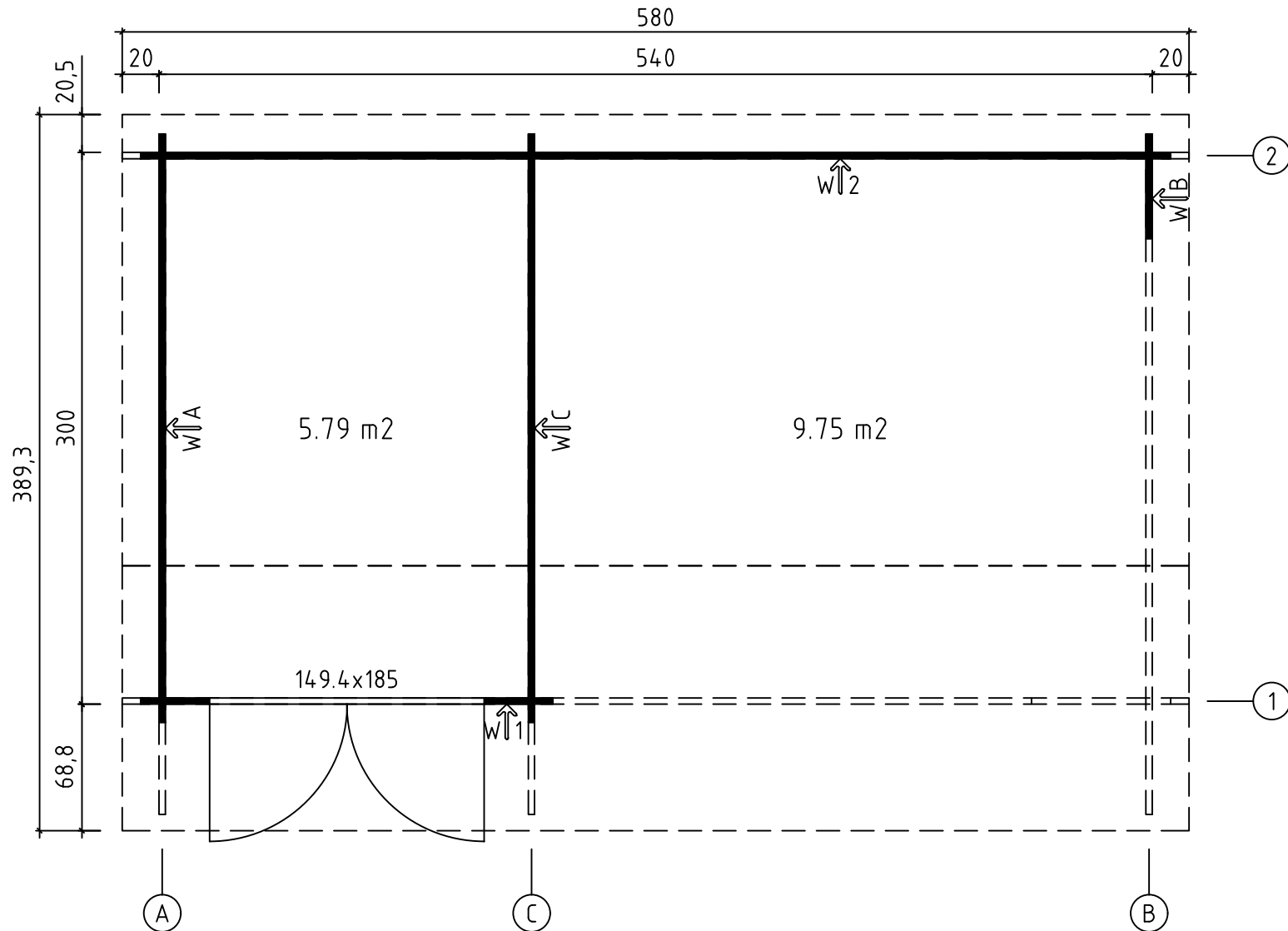

Art. Nr. 3415500

Foundation - Fundament - Fondazione - Fundamenta -
Fundering - Immutatud alusraam



Floor boards - Fussbodenbretter - Plan pose
plancher - Pavimento - Vloerhout - Põrandalaudis

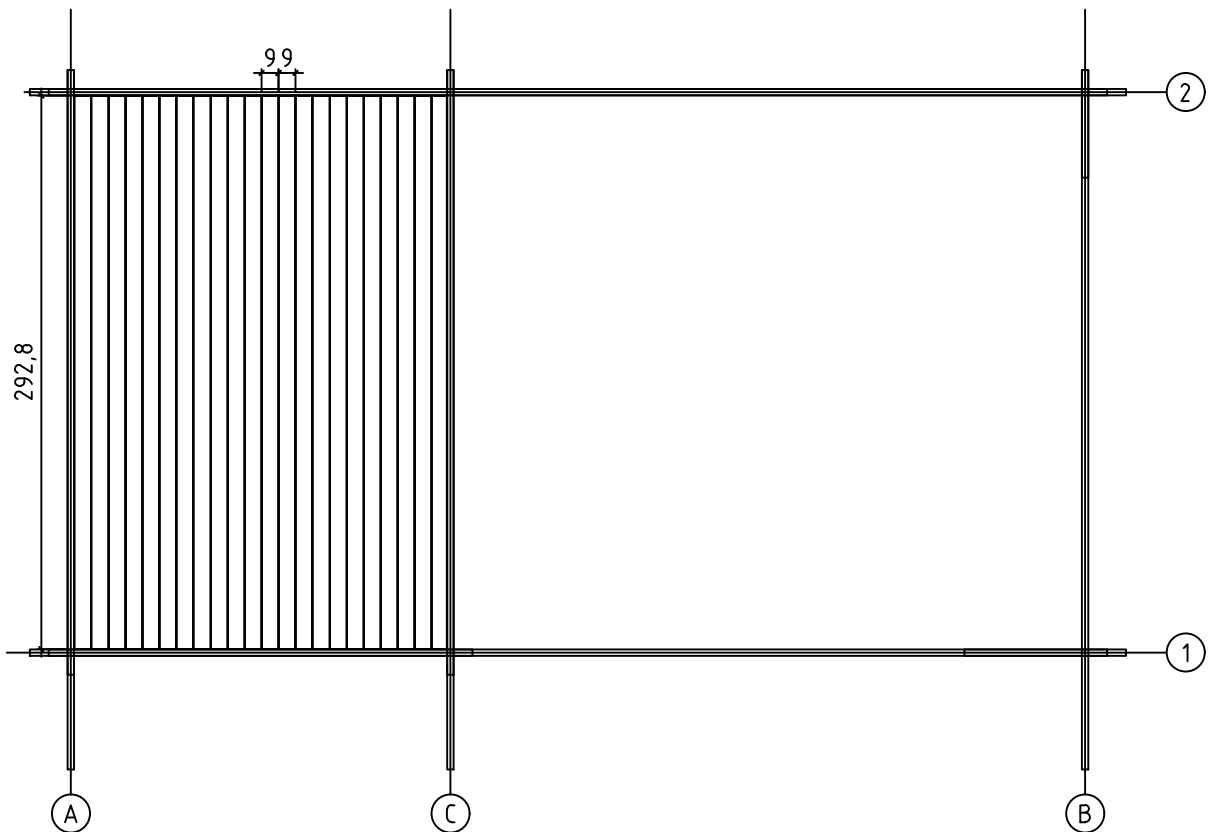



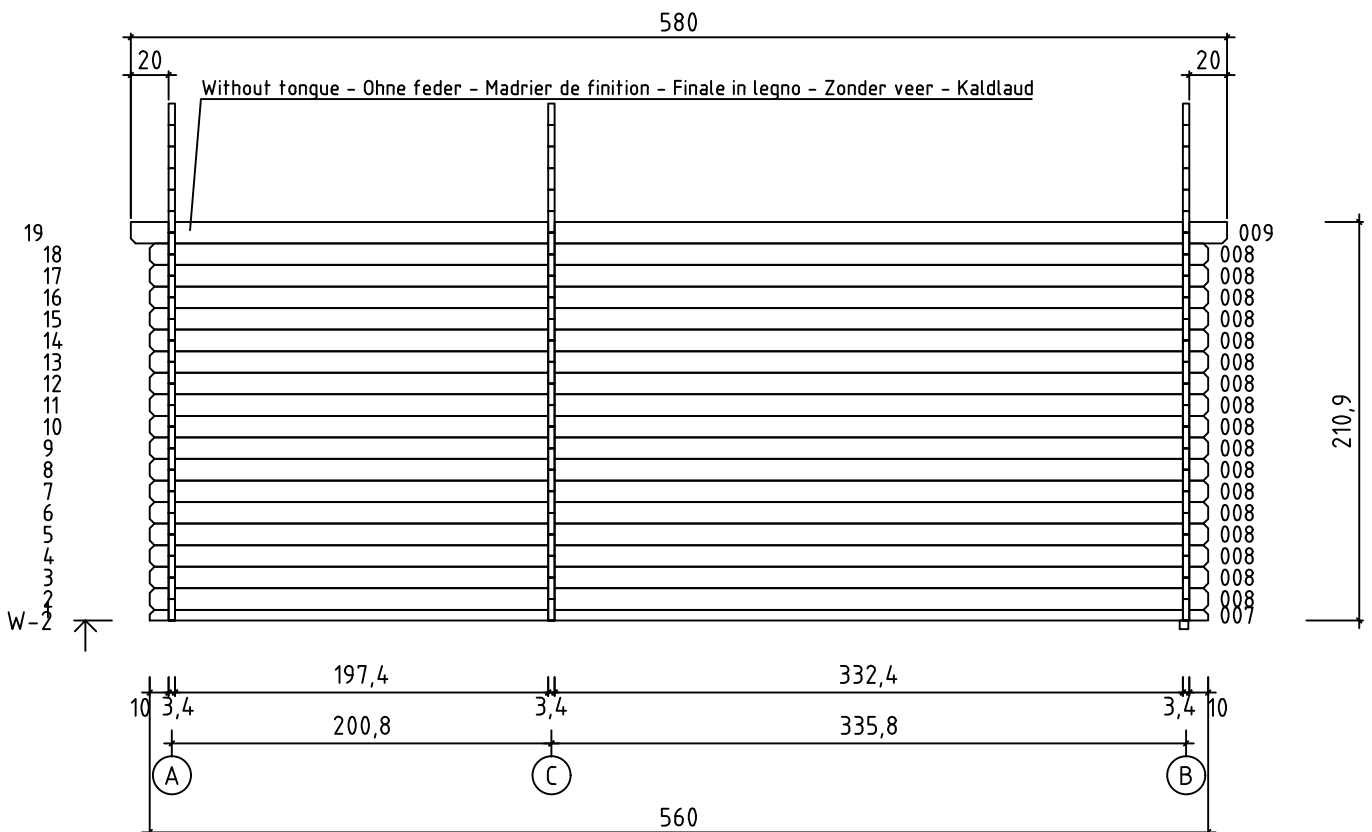
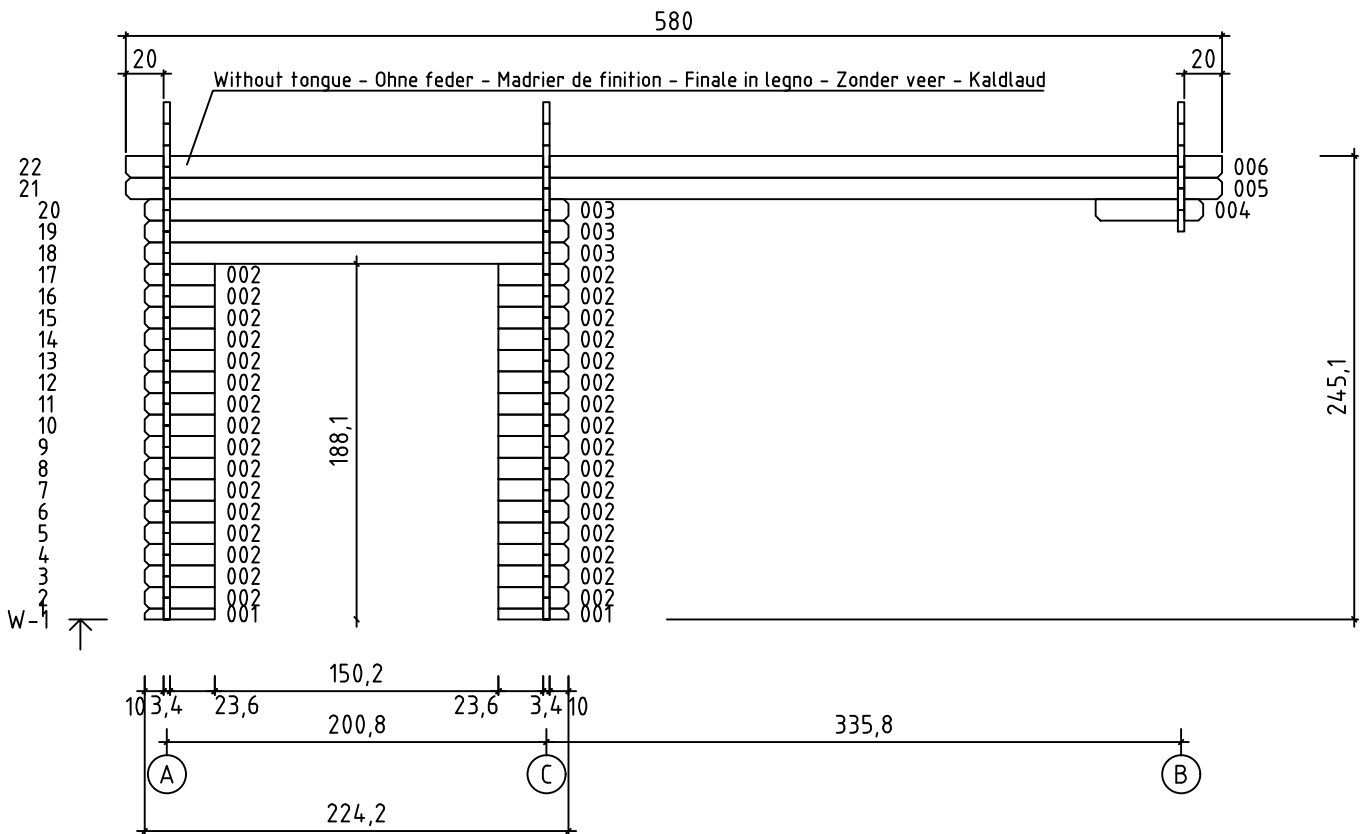



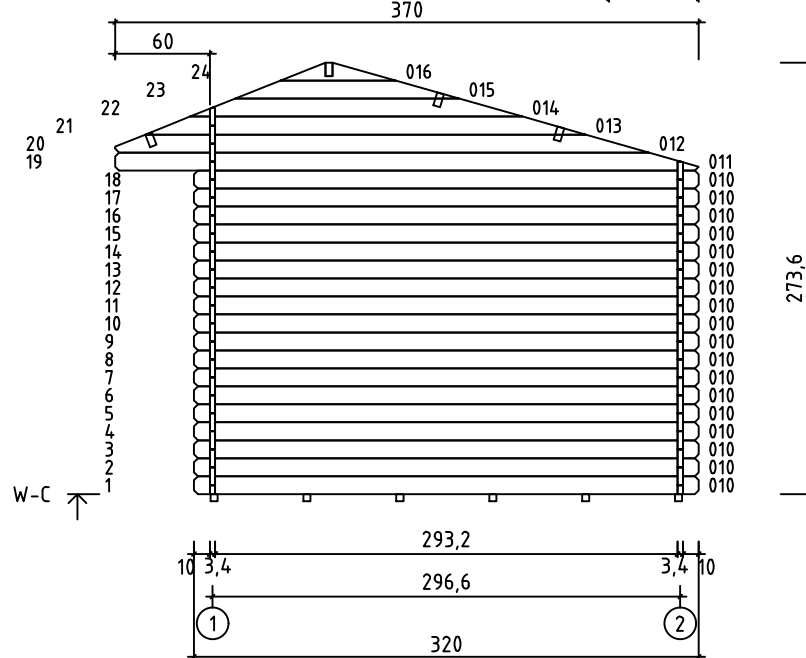
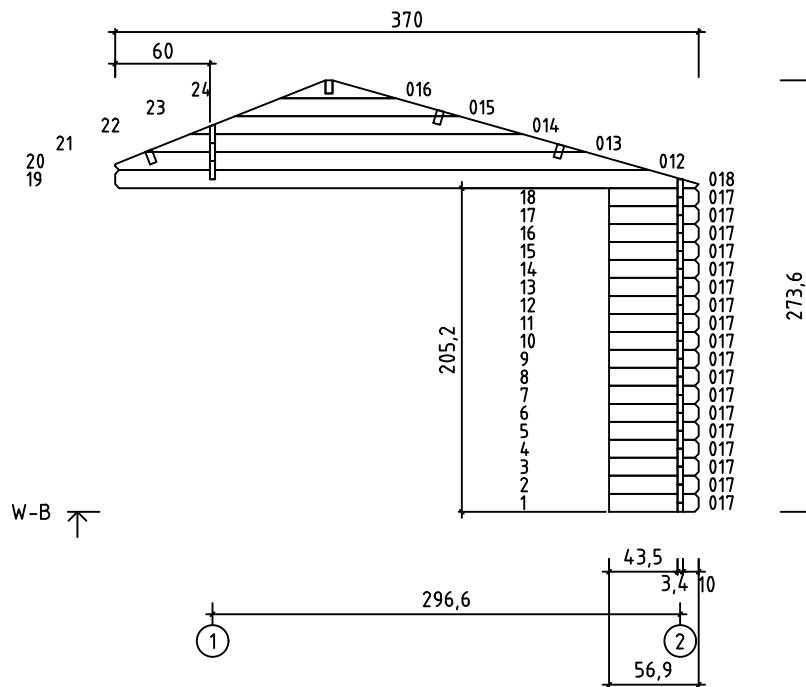
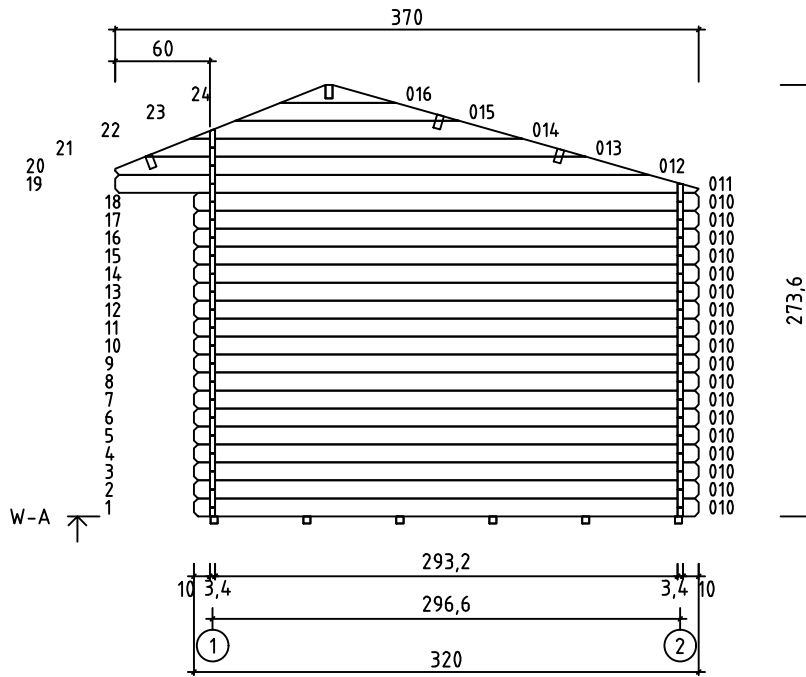



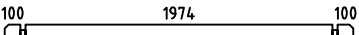

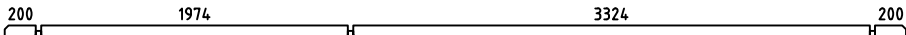
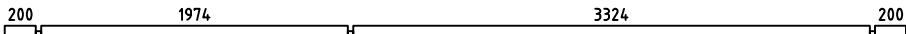
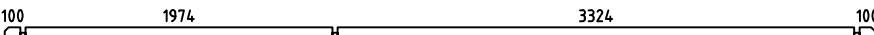
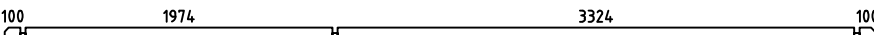
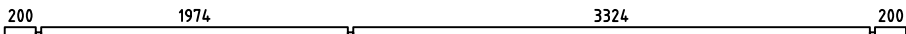
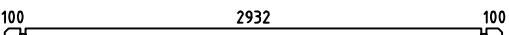

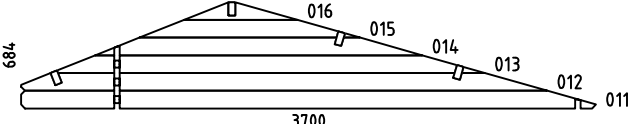
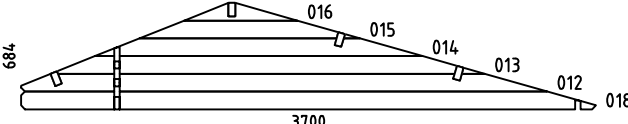
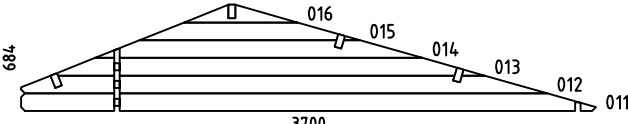
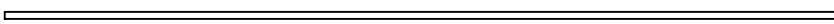
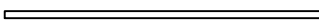

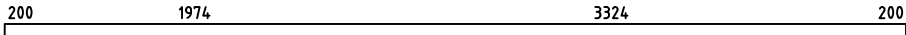
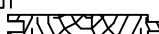
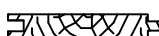

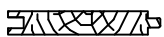



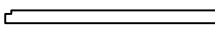

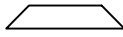
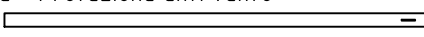

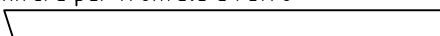
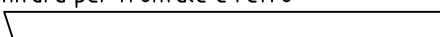

Art. Nr. 3415500





Art. Nr. 3415500

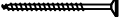
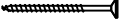
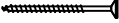
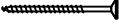
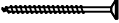
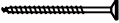
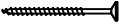
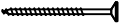
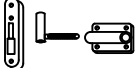
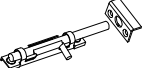
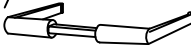

Pos	07.11.2017 Piece list - Stückliste - Liste des pièces - Elementi - Stuklijst - Tükitalabel Art. Nr. 3415500 6/9	Q	P (mm)	L (mm)
001		2	34x57	370
002		32	34x114	370
003		3	34x114	2242
004		1	34x114	569
005		1	34x114	5800
006		1	34x120	5800
007		1	34x57	5600
008		17	34x114	5600
009		1	34x120	5800
010		36	34x114	3200
017		18	34x114	569
WA-1		1		
WB-1		1		
WC-1		1		
IAR2	Foundation - Fundament - Fondation - Fondamenta - Fundering - Immutatud alusraam 	1	45x45	5345
IAR3	Foundation - Fundament - Fondation - Fondamenta - Fundering - Immutatud alusraam 	5	45x45	2032
IAR1	Foundation - Fundament - Fondation - Fondamenta - Fundering - Immutatud alusraam 	1	45x45	459
A-PR1	Roof beam - Dachbalken - Panne de toit - Perlina del tetto - Gordingen / dakbalk - Pärilin 	4	44x140	5800
	Floor boards - Fussbodenbretter - Lame de plancher - Pavimento - Vloerhout - Põrandalaud 	22	90x15	2928
	Roof boards - Dachbretter - Voliges - Perlina per tetto - Dakhout - Katuselaud 	65	90x15	2550

Pos	07.11.2017 Piece list - Stückliste - Liste des pièces - Elementi - Stuklijst - Tükitalabel Art. Nr. 3415500 7/9	Q	P (mm)	L (mm)
	Roof boards - Dachbretter - Voliges - Perlina per tetto - Dakhout - Katuselaud 	65	90x15	1550
	Floor fillet - Fussbodenleiste - Corniere de finition du plancher - Finitura per pavimento (battisco pa) - Vloerafwerkljst - Põrandaliist 		18x18	9.8
	Roofing felt fillet - Dachpappenleiste - Baguette de fixation du feutre bitumeux - Asse per fissaggio guaina bituminosa - Afdekljst asfaltpapier - Katusepapiilist 	2	15x45	1600
	Roofing felt fillet - Dachpappenleiste - Baguette de fixation du feutre bitumeux - Asse per fissaggio guaina bituminosa - Afdekljst asfaltpapier - Katusepapiilist 	2	15x45	2600
	Post - Pfosten - Poteau - Piede registrabile - Stijl - Post 	1	120x120	2000
DRV-1	Roof edge reinforcement - Dachrandverstärkung - Corniere de renfort de bord de toit - Rinforzo x tetto - Dakrand versterking - Räästatugevdus 	4	15x45	2900
	Beam - Balkenlage - Solive(s) - Trave - Balk (gording) - Tala 	2	44x120	620
KFS-1	Storm protection - Sturmleiste - Latte anti-tempete - Protezione anti vento - Stormverankerung / beveiliging - Tormikinnitusliist 	5	22x45	2500
	U-profile - U-profils - Profile u - Profilo ad u - U-profiel - U-profiil 	1	35x70	2017
	Gable moulding - Giebelleiste - Planche de rive - Finitura per frontale e retro del tetto - Gevelljst - Viilulaud 	2	15x120	1600
	Gable moulding - Giebelleiste - Planche de rive - Finitura per frontale e retro del tetto - Gevelljst - Viilulaud 	2	15x120	2600
HS8	Screw for gable segment - Schrauben für deckblatt - Vis pour fixation losange de finition - Viti x frontali tetto - Schroef voor gevelpunt segment - Kruvi rombile 	4	3.5x35	
HS9	Screw for u-profile - Schraube zur befestigung u-profils - Vis a tete fraisée pour profil u - Vite per profilo ad u - Schroef ter bevestiging u-profiel - Kruvi U-profiilite 	10	3.5x50	
HS9	Screw for gable moulding - Schrauben für giebelleiste - Vis pour fixation planche de rive - Vite per fissare finiture davanti e dietro del tetto - Schroef voor gevelljst - Kruvi viilulauale 	28	3.5x50	
HS4	Screw for roof edge reinforcement - Schrauben für dachrandverstärkung - Vis pour fixation corniere renfort de bord de toit - Viti x rinforzo bordo tetto - Schroef voor dakrand versterking - Kruvi räästatugevdusele 	14	3x30	
HS13	Screw for beam - Schrauben zur befestigung dachsparren - Vis pour solive (s) - Viti per perline - Schroef voor balk (gording) - Kruvi talale 	8	4x60	
HS18	Screw for roof beams - Schrauben für dachbalken - Vis pour fixation pannes de toit - Viti per perline del tetto - Schroef voor gordingen / dakbalken - Kruvi pärlinitele 	12	5x120	
HS18	Screw for gable - Schrauben für giebel - Vis pour fixation des pignons - Viti per timpano - Schroef voor gevelpunt - Kruvi viilude kinnitamiseks 	6	5x120	
HS16	Screw for 1. wall beam - Schraube für 1. bohlenreihe - Vis de fixations 1ere rangée de madriers avec poutrelles de fondations - Vite fissaggio alle fondamenta - Schroef voor 1 wandbalk - Kruvi poollauale 	5	5x90	
HS16	Screw for foundation - Schrauben zur befestigung fundament - Vis de fixations des poutrelles de fondations - Viti x fondamenta - Schroef voor fundering - Kruvi alusraamile 	1	5x90	
HS16	Screw for post - Schrauben für pfosten - Vis de fixation des poteaux - Viti per inviare - Schroef voor stijlen - Kruvi postile 	2	5x90	
HS22	Screw for roof beams - Schrauben für dachbalken - Vis pour fixation pannes de toit - Viti per perline del tetto - Schroef voor gordingen / dakbalken - Kruvi pärlinitele 	2	6x150	
HS20	Screw for post height adjustment - Schrauben für regulierungsschraube für pfosten - Vis de fixation de support réglable de poteau - Viti per fissare ed aggiustare l'altezza del palo verticale - Schroef voor hoogte instelling stijlen - Kruvi vajumispolidile 	8	6x50	

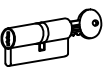
Pos	07.11.2017	Piece list - Stückliste - Liste des pièces - Elementi - Stuklijst - Tükítabel 1494x1850 TUK.2.046.TSVP.MMX34 SGA+28	9/9	Q	P (mm)	L (mm)
HS1		Screw for georgian bars - Schraube für sprossen - Vis pour croisillons - Viti per unire la griglia georgiana della finestra - Schroeven voor raamverdeling - Kruvi ukse petfeliistule		12	2.5x20	
HS9		Screw for fixing door to the wall - Schraube zur Befestigung für - zarge mit wand - Vis de fixation partie basse dormants de porte au 1er rang de madrier - Viti per fissare la porta alla parete - Schroef voor bevestiging deur naar wand - Kruvi ukse lüüsi seinale		2	3.5x50	
HS4		Screw for door fillet - Schraube zur Befestigung türleiste - Vis pour fixation baguette d'arrêt de porte - Viti per massellino della porta - Schroef voor deurlijst - Kruvi ukse kokkuvaltšiliistule		5	3x30	
HS11		Screw for fixing bolt hinge - Schraube für türband - Vis pour fixation gonds de porte - pour ouvrant - Viti per fissaggio cardini e cerniere della porta - Schroef voor scharnier - Kruvi ukse polthingele		16	4x30	
HS12		Screw for fixing bolt hinge - Schraube für türband - Vis pour fixation gonds de porte - pour ouvrant - Viti per fissaggio cardini e cerniere della porta - Schroef voor scharnier - Kruvi ukse polthingele		12	4x40	
HS13		Screw for door jamb - Schraube für türrahmen - Vis de fixation partie haute avec montants du cadre de porte - Viti x fissaggio montanti porte - Schroef voor deurkozijn - Kruvi ukse lengile		2	4x60	
HS16		Screw for door jamb - Schraube für türrahmen - Vis de fixation partie haute avec montants du cadre de porte - Viti x fissaggio montanti porte - Schroef voor deurkozijn - Kruvi ukse lengile		2	5x90	
HS25		Screw for doorstep - Schrauben für swelle - Vis pour fixation barre de seuil - Vite per soglia della porta - Schroef voor deurdorpel - Kruvi lävepakule		3	4.5x65	
		Male bolt hinge for door - Türband - Partie male de paumelle de porte - Cerniera anube x porta - Scharnier bout - Polthing adapteriga DIN15-57		4		
TL		Latch bolt for double door - Türriegel - Loquet pour double porte - Scrocco per porta doppia - Nachtslot - Riiv		2		
TL4		Door handle fittings - Türgriff - Poignée de porte - Maniglie - Deurhendel / klink - Ukse käepide VU		1		
TL5		Set of door lock covers - Schlossblenden - Set de garnitures de porte - Copertura serrature - Slot sluitplaat set - Ukse lukuplaat		1		
		Cylinder lock - Zylinderschloss - Barillet de porte - Serratura - Cylinder slot - Ukse lukusüdamik		1	30x30	

Glass size - Glasgröße - Taille de la vitre - Misura del vetro - Glas afmeting - Klaasi mõõt: 502x900 mm

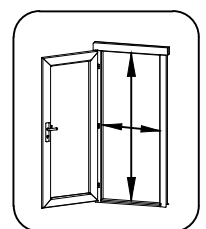
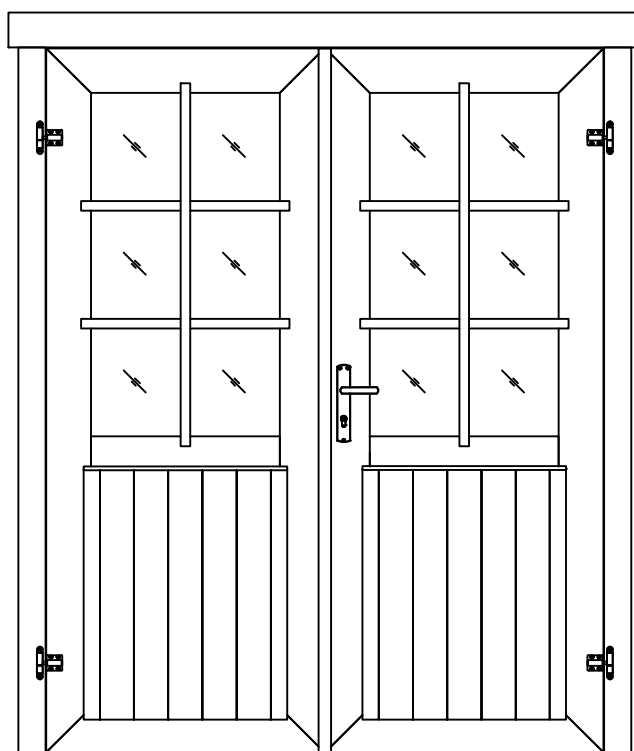

1418x1794 mm