

Jelle 175 Plus  
Art. Nr. 2839150

1/7

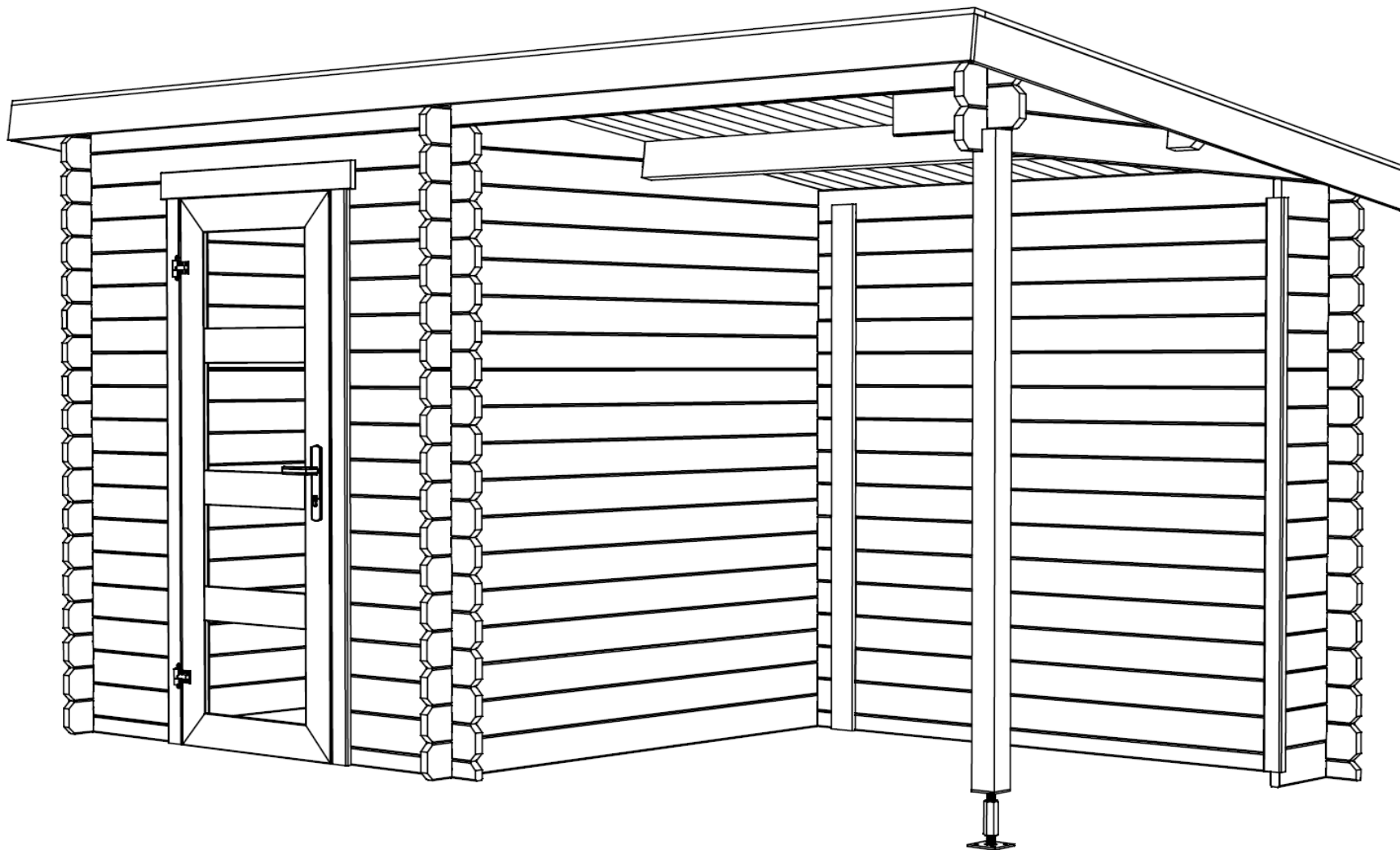

2.10.2017

Art.Nr. 2839150



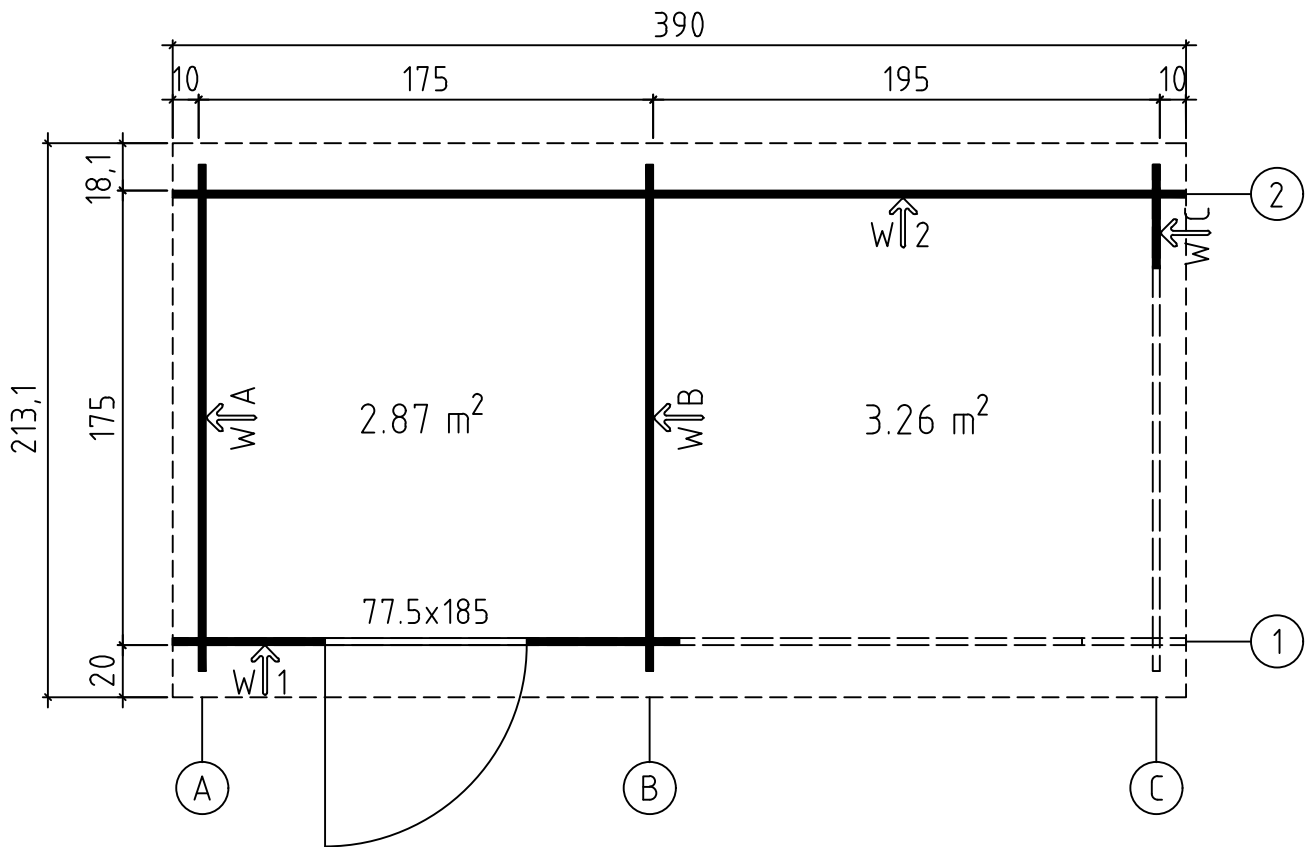



Groundplan - Grundplan - Plan de masse - Planimetria - Plattegrond - Põhiplaan

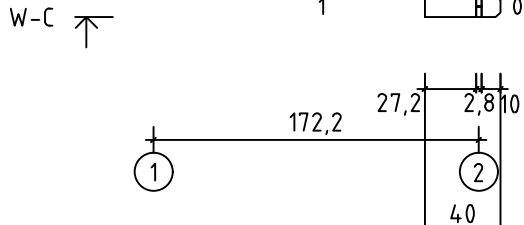
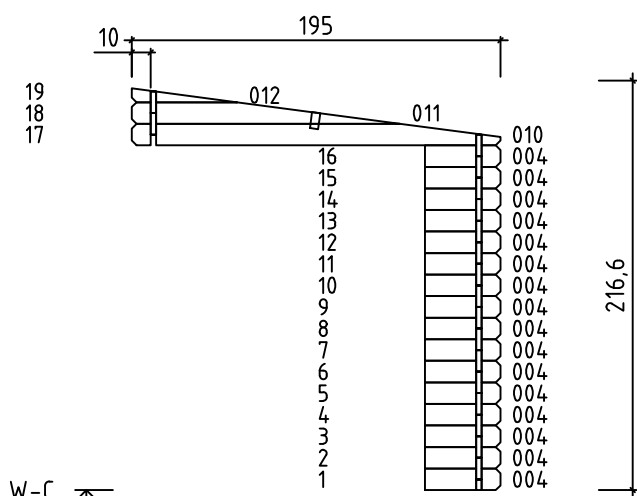
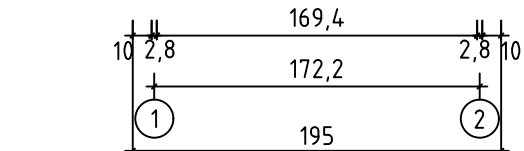
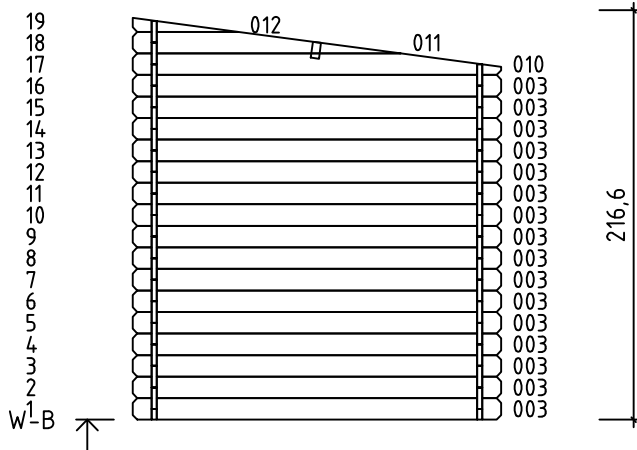
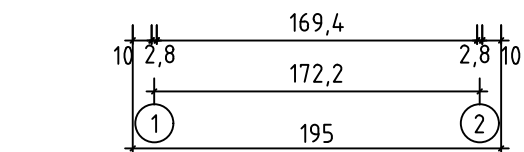
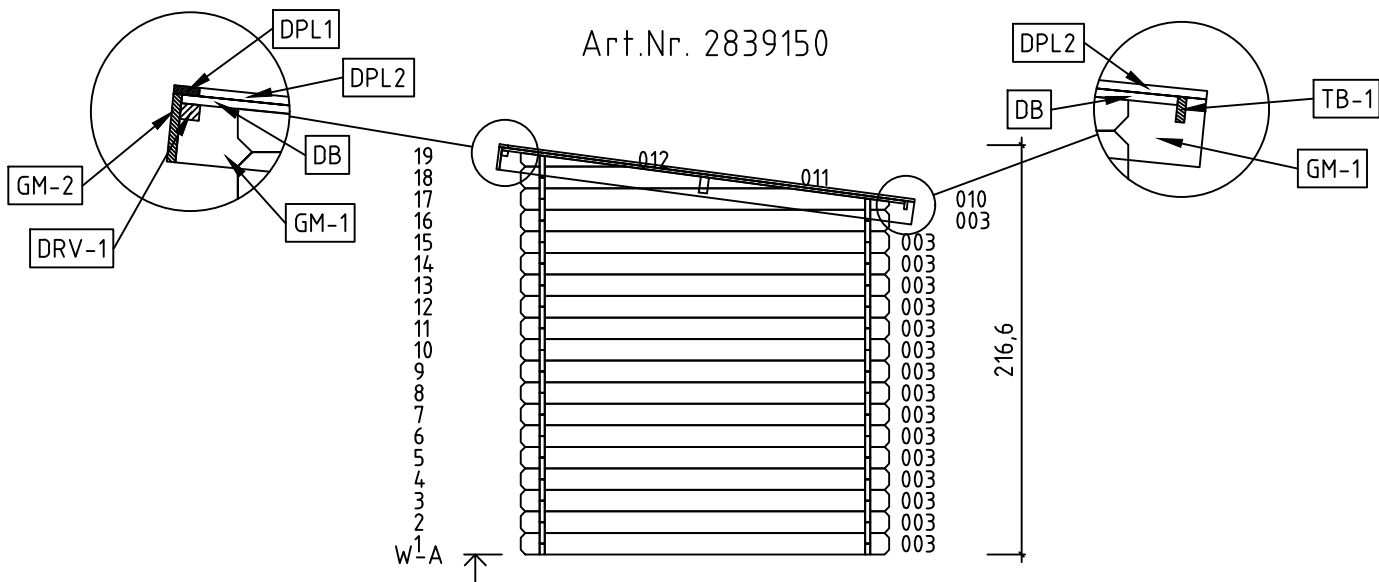

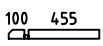
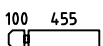
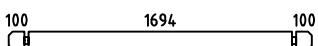

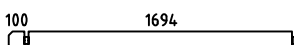
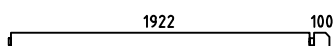
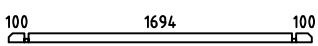
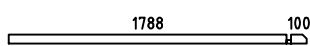
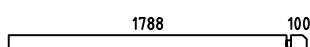
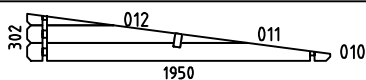
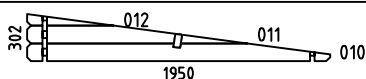
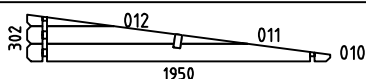
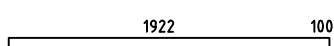
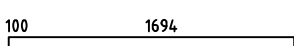
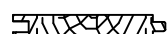
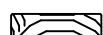

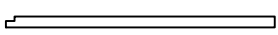
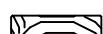

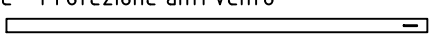

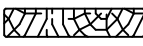
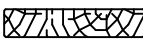
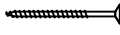
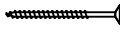
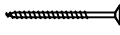

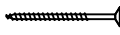
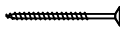
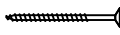
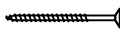
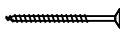

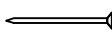
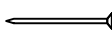
Art.Nr. 2839150

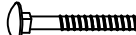

Pos	02.10.2017 Piece list - Stückliste - Liste des pièces - Elementi - Stuklijst - Tükitalabel Art.Nr. 2839150 5/7	Q	P (mm)	L (mm)
001		2	28x57	583
002		32	28x114	583
003		48	28x114	1950
004		17	28x114	400
005		2	28x114	1836
006		2	28x114	2064
007		1	28x57	1950
008		1	28x57	1916
009		15	28x114	1916
WA-1		1		
WB-1		1		
WC-1		1		
A-PR2	 ABIPÄRLINID	1	44x120	2064
A-PR1	 ABIPÄRLINID	1	44x120	1836
DB	Roof boards - Dachbretter - Voliges - Perlina per tetto - Dakhout - Katuselaud 	44	90x15	2150
DPL2	Roofing felt fillet - Dachpappenleiste - Baguette de fixation du feutre bitumeux - Asse per fissaggio guaina bituminosa - Afdekljst asfaltpapier - Katusepapiliist 	2	15x45	2170
DPL1	Roofing felt fillet - Dachpappenleiste - Baguette de fixation du feutre bitumeux - Asse per fissaggio guaina bituminosa - Afdekljst asfaltpapier - Katusepapiliist 	1	15x45	3930
DPP-1	Roofing felt (strip) - Dachpappe (bahnen) - Feutre bitumeux (bande) - Cartone catramato - Asfaltpapier (baan) - Katusepapp 	3		4000
	Post - Pfosten - Poteau - Piede registrabile - Stijl - Post 	1	70x70	1730
TB-1	Fascia board - Traufbrett - Bandeau de toit - Finitura lati tetto - Gevellijst - Räästalaud 	1	15x45	3900
	H-profile - H-profilis - Profile h - Profilo ad h - H-profiel - H-profiil 	1	90x58	1825
DRV-2	Roof edge reinforcement - Dachrandverstärkung - Corniere de renfort de bord de toit - Rinforzo x tetto - Dakrand versterking - Räästatugevdus 	1	28x34	3900
KFS-1	Storm protection - Sturmleiste - Latte anti-tempete - Protezione anti vento - Stormverankering / beveiliging - Tormikinnitusliist 	5	22x45	2050

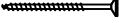
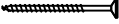
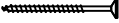
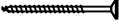
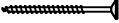
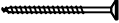
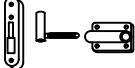
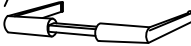
Pos	02.10.2017 Piece list - Stückliste - Liste des pièces - Elementi - Stuklijst - Tükítabel Art.Nr. 2839150 6/7	Q	P (mm)	L (mm)
	U-profile - U-profils - Profile u - Profilo ad u - U-profiel - U-profiil 	1	28x58	1726
GM-1	Gable moulding - Giebelleiste - Planche de rive - Finitura per frontale e retro del tetto - Gevellijst - Viilulaud 	2	15x120	2215
GM-2	Gable moulding - Giebelleiste - Planche de rive - Finitura per frontale e retro del tetto - Gevellijst - Viilulaud 	1	15x120	3900
HS9	Screw for u-profile - Schraube zur befestigung u-profils - Vis a tete fraisée pour profil u - Vite per profilo ad u - Schroef ter bevestiging u-profiel - Kruvi U-profiilite 	5	3.5x50	
HS9	Screw for gable moulding - Schrauben für giebelleiste - Vis pour fixation planche de rive - Vite per fissare finiture davanti e dietro del tetto - Schroef voor gevellijst - Kruvi viilulauale 	12	3.5x50	
HS4	Screw for fascia boards - Schrauben für traufbretter - Vis pour fixation bandeau de toit - Viti x striscia del tetto - Schroef voor gevellijst - Kruvi räästalauale 	9	3x30	
HS12	Screw for roof edge reinforcement - Schrauben für dachrandverstärkung - Vis pour fixation corniere renfort de bord de toit - Viti x rinforzo bordo tetto - Schroef voor dakrand versterking - Kruvi räästatugevdusele 	9	4x40	
HS12	Screw for gable moulding - Schrauben für giebelleiste - Vis pour fixation planche de rive - Vite per fissare finiture davanti e dietro del tetto - Schroef voor gevellijst - Kruvi viilulauale 	9	4x40	
HS13	Screw for post - Schrauben für pfosten - Vis de fixation des poteaux - Viti per inviare - Schroef voor stijlen - Kruvi postile 	2	4x60	
HS18	Screw for roof beams - Schrauben für dachbalken - Vis pour fixation pannes de toit - Viti per perline del tetto - Schroef voor gordingen / dakbalken - Kruvi pärlinitele 	4	5x120	
HS18	Screw for gable - Schrauben für giebel - Vis pour fixation des pignons - Viti per timpano - Schroef voor gevelpunt - Kruvi viilude kinnitamiseks 	6	5x120	
HS20	Screw for post height adjustment - Schrauben für regulierungsschraube für pfosten - Vis de fixation de support réglable de poteau - Viti per fissare ed aggiustare l'altezza del palo verticale - Schroef voor hoogte instelling stijlen - Kruvi vajumispolidile 	8	6x50	
SH28	Hammer block - Schlagholz - Calle de frappe - Blocco di legno da usare come cuscinetto quando si usa il martello - Slagklos - Löögiklots 	1		
SFS	Nut for storm protection - Schraubenmutter für sturmleiste - Ecrou pour latte anti-tempete - Dado x asta protezione vento - Moer voor stormverankering - Mutter tormikinnitusliistule 	10	D6	
NF4	Zn nail for roof - Zn nagel für dachbretter - Pointe pour fixation voliges de toit - Chiodi x perline tetto - Spijker(nagel) voor dakhout - Nael katuselauale 	141	2x50	
NF5	Zn nail for roofing felt fillet - Zn nagel für dachpappenleiste - Pointe pour baguette de fixation feutre bitumeux - Chiodi x carta bituminosa x tetto - Spijker(nagel) voor asfaltpapier afdekljst - Papiliistunael 	17	2x40	
NF6	Roofing nails for roofing felt - Nägel für dachpappe - Pointe pour fixation feutre bitumeux - Chiodi per cartone catramato - Asfaltnagel - Papinael 	108	2.8x15	
BFS	Bolt for storm protection - Bolzen für sturmleiste - Boulon pour latte anti-tempete - Bullone x asta protezione vento - Bout voor stormankerlat - Puidupolt tormikinnitusliistule 	10	6x60	
DFS	Washer for storm protection - Dichtscheibe für sturmleiste - Rondelle pour latte anti-tempete - Rondella x asta protezione vento - Afdichtring voor storm strip - Seib tormikinnitusliistule 	10	D6	
	Post height adjustment - Regulierungsschraube für pfosten - Support réglable de poteau - Piede registrabile in altezza - Stelschroef voor stijlpost - Vajumispoltt 	1	D20	
	Door - Tür - Porte - Deur - Uks 775x1850 UK.4.020.SVV.MMX28 SGA+28	1		

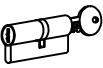
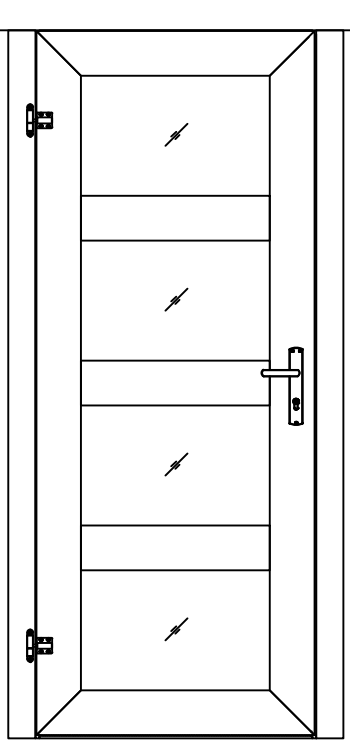
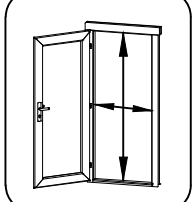
Pos	02.10.2017 Piece list - Stückliste - Liste des pièces - Elementi - Stuklijst - Tükítabel 775x1850 UK.4.020.SVV.MMX28 SGA+28 7/7	Q	P (mm)	L (mm)	
HS9	Screw for fixing door to the wall - Schraube zur Befestigung für - zarge mit wand - Vis de fixation partie basse dormant de porte au 1er rang de madrier - Viti per fissare la porta alla parete - Schroef voor bevestiging deur naar wand - Kruvi ukseleingi kinnitamiseks seinale		2	3.5x50	
HS11	Screw for fixing bolt hinge - Schraube für Türband - Vis pour fixation gonds de porte - pour ouvrant - Viti per fissaggio cardini e cerniere della porta - Schroef voor scharnier - Kruvi ukse polthingele		8	4x30	
HS12	Screw for fixing bolt hinge - Schraube für Türband - Vis pour fixation gonds de porte - pour ouvrant - Viti per fissaggio cardini e cerniere della porta - Schroef voor scharnier - Kruvi ukse polthingele		6	4x40	
HS13	Screw for door jamb - Schraube für Türrahmen - Vis de fixation partie haute avec montants du cadre de porte - Viti x fissaggio montanti porte - Schroef voor deurkozijn - Kruvi ukse lengile		2	4x60	
HS16	Screw for door jamb - Schraube für Türrahmen - Vis de fixation partie haute avec montants du cadre de porte - Viti x fissaggio montanti porte - Schroef voor deurkozijn - Kruvi ukse lengile		2	5x90	
HS25	Screw for doorstep - Schrauben für swelle - Vis pour fixation barre de seuil - Vite per soglia della porta - Schroef voor deurdorpel - Kruvi lävepakule		2	4.5x65	
	Male bolt hinge for door - Türband - Partie male de paumelle de porte - Cerniera anube x porta - Scharnier bout - Polthing adapteriga DIN15-57		2		
TL4	Door handle fittings - Türgriff - Poignée de porte - Maniglie - Deurhendel / klink - Ukse käepide		1		
TL5	Set of door lock covers - Schlossblenden - Set de garnitures de porte - Copertura serrature - Slot sluitplaat set - Ukse lukuplaat		1		
	Cylinder lock - Zylinderschloss - Barillet de porte - Serratura - Cylinder slot - Ukse lukusüdamik		1	30x30	
<p>Glass size - Glasgröße - Taille de la vitre - Misura del vetro - Glas afmeting - Klaasi mõõt: 502x325 mm</p> <div style="display: flex; justify-content: space-around; align-items: center;">  <div style="text-align: center;">  <p>702x1792 mm</p> </div> </div>					