

INDI 175
Art. Nr. 2834050

1/7

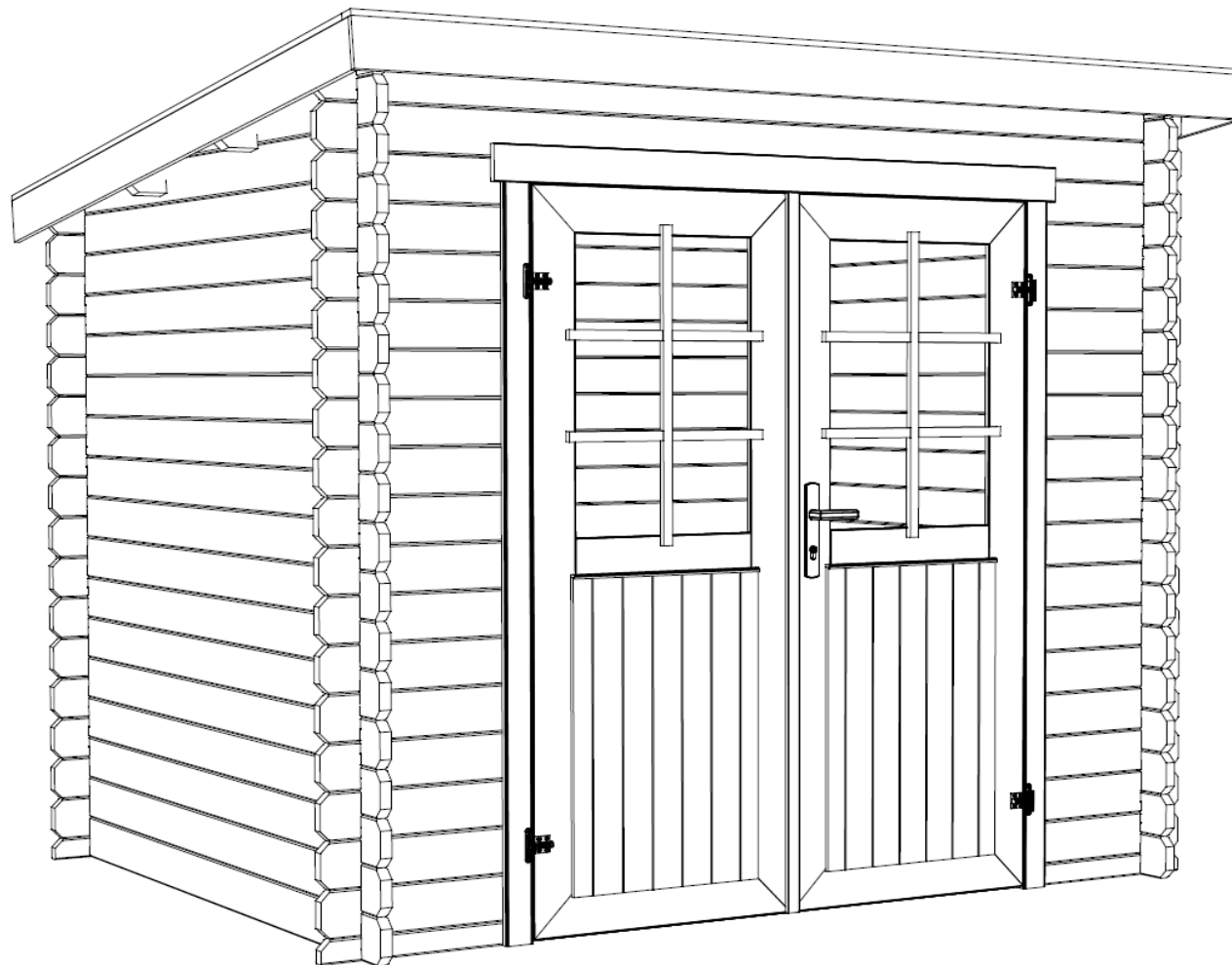

24.08.2017



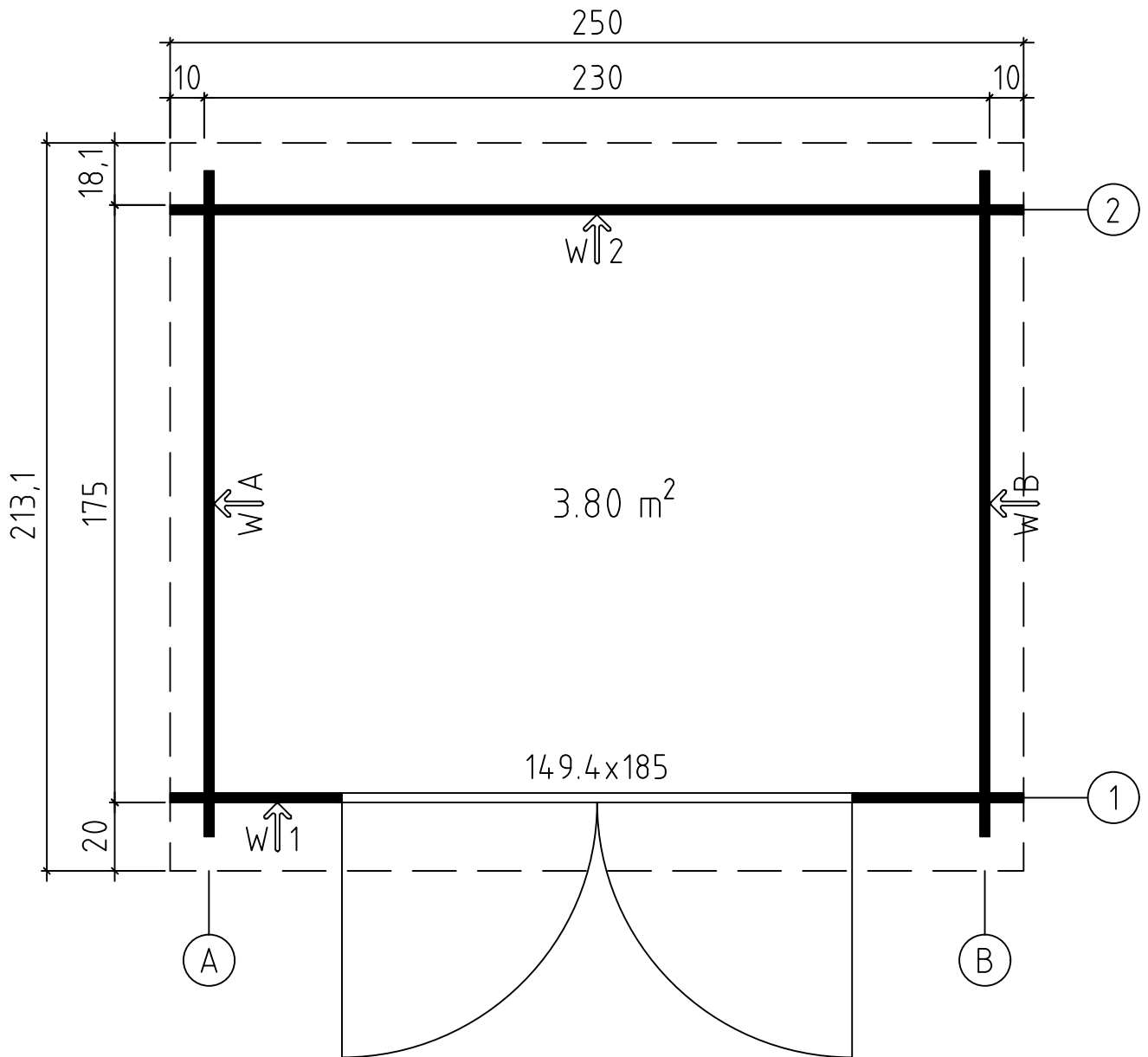

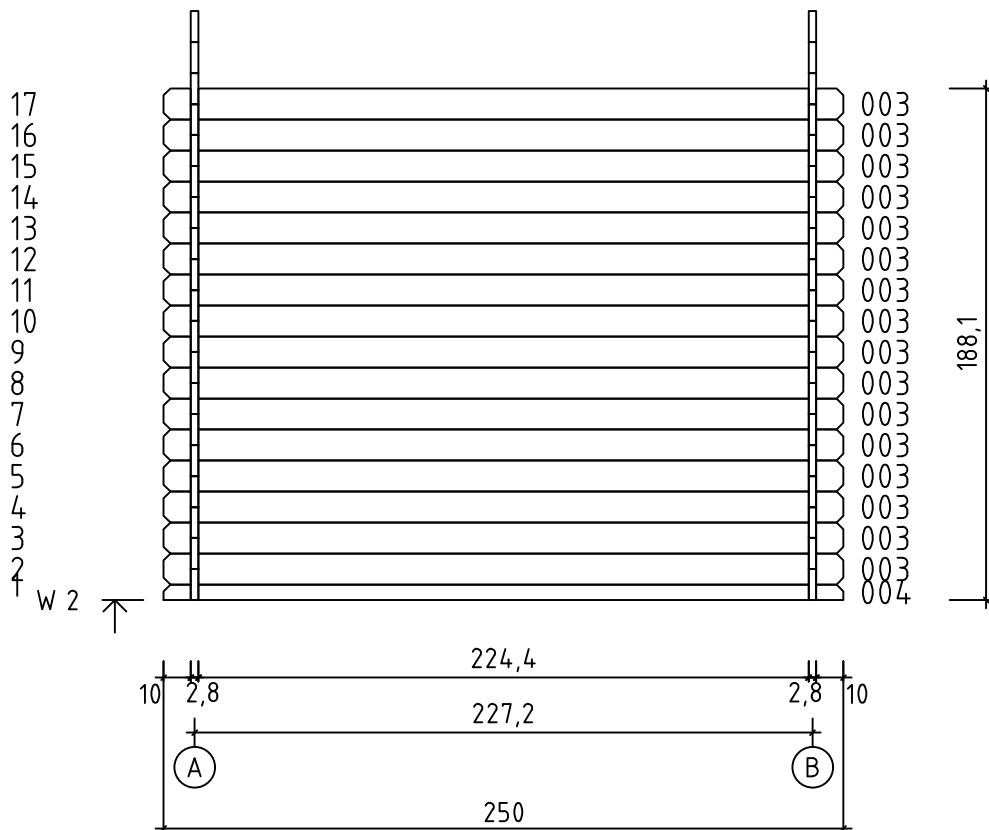
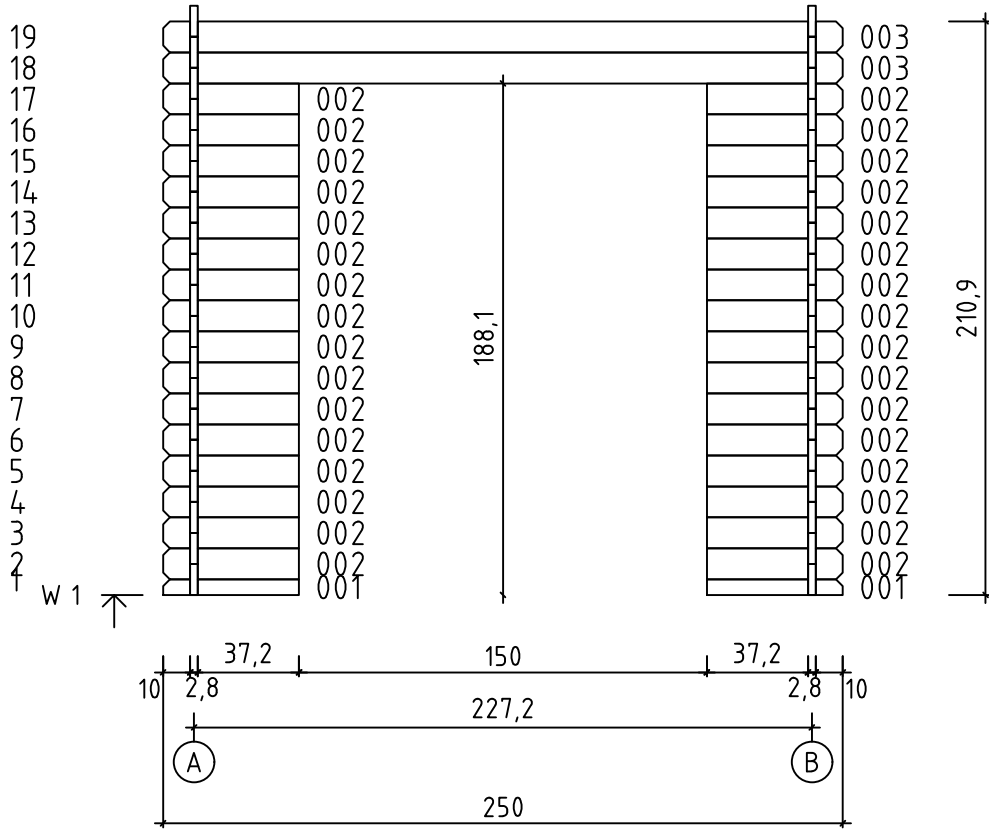



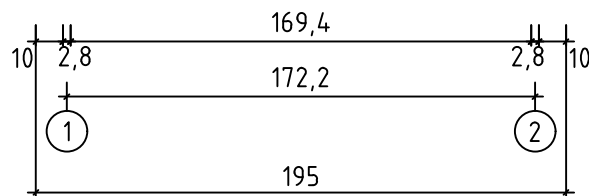
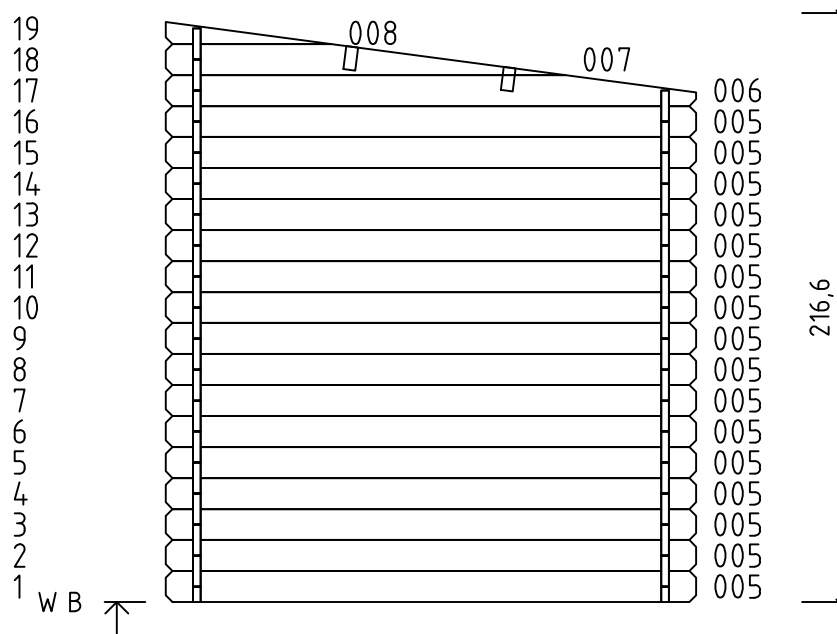
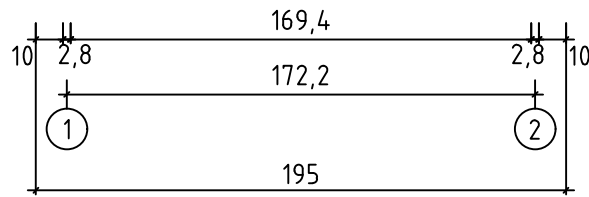
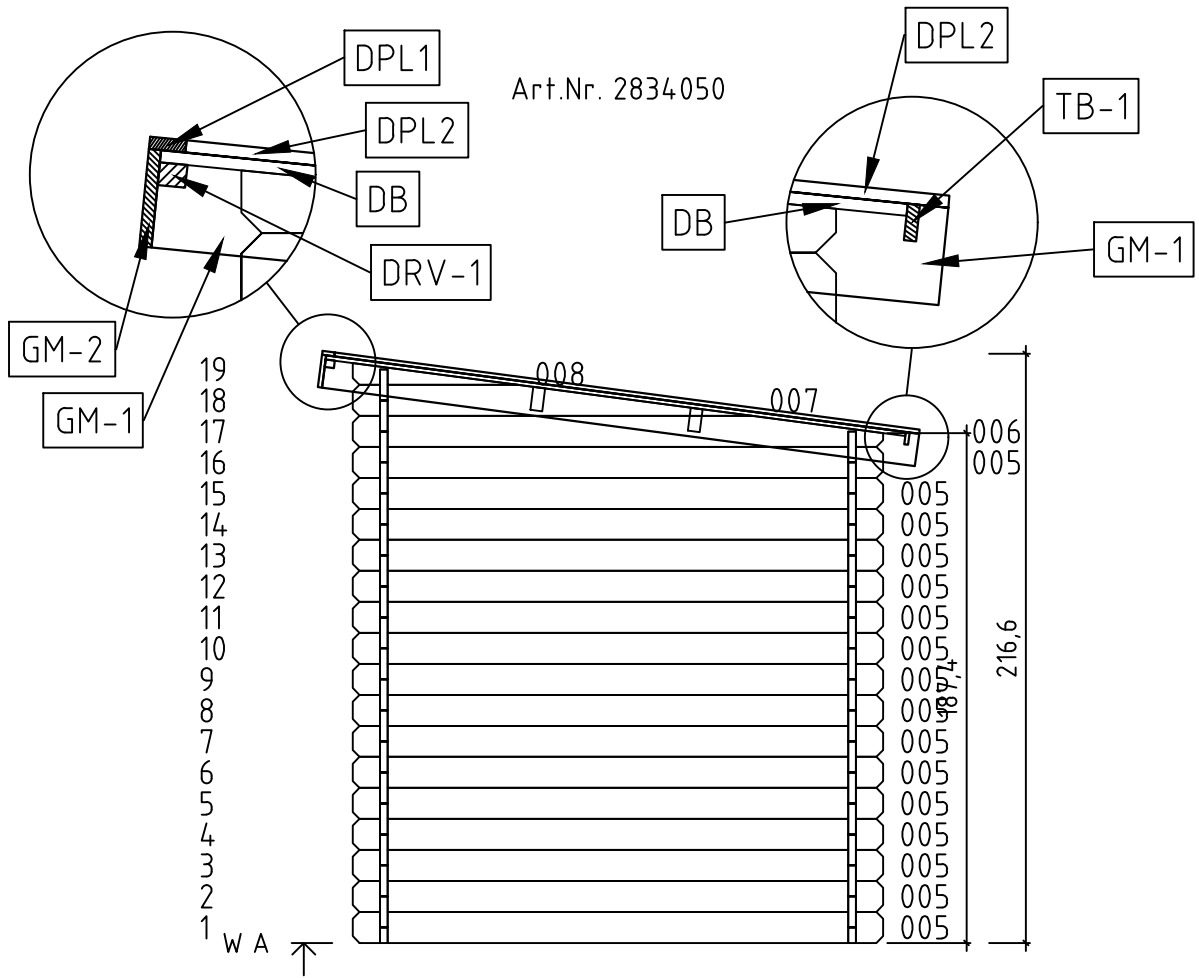

Groundplan - Grundplan - Plan de masse - Planimetria - Plattegrond - Põhiplaan

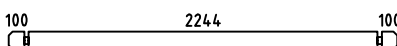
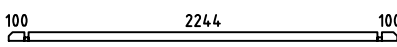
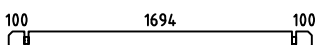
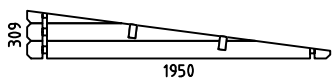
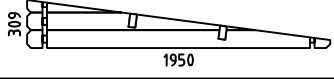
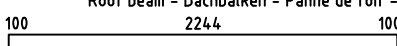

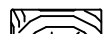
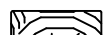
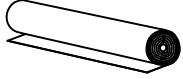
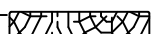

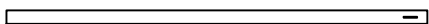
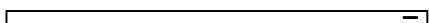
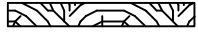

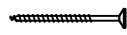
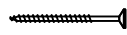
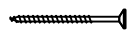

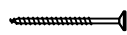
Art.Nr. 2834050

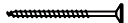
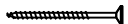
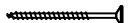
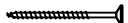
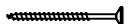
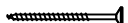

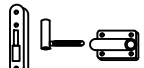
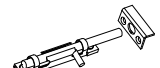
Pos	24.08.2017 Piece list - Stückliste - Liste des pièces - Elementi - Stuklijst - Joonis Art.Nr. 2834050	5/7	Q	P (mm)	L (mm)
001			2	28x57	500
002			32	28x114	500
003			18	28x114	2500
004			1	28x57	2500
005			32	28x114	1950
WA-1			1		
WB-1			1		
A-PR1	Roof beam - Dachbalken - Panne de toit - Perlina del tetto - Gordingen / dakbalk - Abipärlineid 		2	44x120	2500
DB	Roof boards - Dachbretter - Voliges - Perlina per tetto - Dakhout - Katuselaud 		28	90x15	2150
DPL2	Roofing felt fillet - Dachpappenleiste - Baguette de fixation du feutre bitumeux - Asse per fissaggio guaina bituminosa - Afdeklijst asfaltpapier - Katusepapiilist 		2	15x45	2170
DPL1	Roofing felt fillet - Dachpappenleiste - Baguette de fixation du feutre bitumeux - Asse per fissaggio guaina bituminosa - Afdeklijst asfaltpapier - Katusepapiilist 		1	15x45	2530
DPP-1	Roofing felt (strip) - Dachpappe (bahnen) - Feutre bitumeux (bande) - Cartone catramato - Asfaltpapier (baan) - Katusepapp 		3		2600
TB-1	Fascia board - Traufbrett - Bandeau de toit - Finitura lati tetto - Gevellijst Räästalaud 		1	15x45	2500
DRV-1	Roof edge reinforcement - Dachrandverstärkung - Corniere de renfort de bord de toit - Rinforzo x tetto - Dakrand versterking - Räästatugevdus 		1	28x34	2500
KFS-1	Storm protection - Sturmleiste - Latte anti-tempete - Protezione anti vento - Stormverankering / beveiliging - Tormikinnitus 		2	22x45	2050
KFS-2	Storm protection - Sturmleiste - Latte anti-tempete - Protezione anti vento - Stormverankering / beveiliging - Tormikinnitus 		2	22x45	2500
GM-1	Gable moulding - Giebelleiste - Planche de rive - Finitura per frontale e retro del tetto - Gevellijst - Viilulaud 		2	15x120	2200
GM-2	Gable moulding - Giebelleiste - Planche de rive - Finitura per frontale e retro del tetto - Gevellijst - Viilulaud 		1	15x120	2530
HS9	Screw for gable moulding - Schrauben für giebelleiste - Vis pour fixation planche de rive - Vite per fissare finiture davanti e dietro del tetto - Schroef voor gevellijst - Kruvi viilulauale 		16	3.5x50	
HS4	Screw for fascia boards - Schrauben für traufbretter - Vis pour fixation bandeau de toit - Viti x striscia del tetto - Schroef voor gevellijst - Kruvi räästalauale 		6	3x30	
HS12	Screw for roof edge reinforcement - Schrauben für dachrandverstärkung - Vis pour fixation corniere renfort de bord de toit - Viti x rinforzo bordo tetto - Schroef voor dakrand versterking - Kruvi räästatugevdusele 		6	4x40	
HS12	Screw for gable moulding - Schrauben für giebelleiste - Vis pour fixation planche de rive - Vite per fissare finiture davanti e dietro del tetto - Schroef voor gevellijst - Kruvi viilulauale 		6	4x40	
HS18	Screw for roof beams - Schrauben für dachbalken - Vis pour fixation pannes de toit - Viti per perline del tetto - Schroef voor gordingen / dakbalken - Kruvi pärlinitele 		4	5x120	

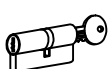
Pos	24.08.2017	Piece list - Stückliste - Liste des pièces - Elementi - Stuklijst - Joonis 1494x1850 TUK.2.056.SVP.MMX28 SGA+28	7/7	Q	P (mm)	L (mm)
HS1		Screw for georgian bars - Schraube für sprossen - Vis pour croisillons - Viti per unire la griglia georgiana della finestra - Schroeven voor raamverdeling - Kruvi ukse petfeliistule		12	2.5x20	
HS9		Screw for fixing door to the wall - Schraube zur Befestigung für - zarge mit wand - Vis de fixation partie basse dormants de porte au 1er rang de madrier - Viti per fissare la porta alla parete - Schroef voor bevestiging deur naar wand - Kruvi ukse selengi kinnifamiseks seinale		2	3.5x50	
HS4		Screw for door fillet - Schraube zur Befestigung türleiste - Vis pour fixation baguette d'arret de porte - Viti per massellino della porta - Schroef voor deurlijst - Kruvi ukse kokkuvaltsiliistule		5	3x30	
HS11		Screw for fixing bolt hinge - Schraube für türband - Vis pour fixation gonds de porte - pour ouvrant - Viti per fissaggio cardini e cerniere della porta - Schroef voor scharnier - Kruvi ukse polthingele		16	4x30	
HS12		Screw for fixing bolt hinge - Schraube für türband - Vis pour fixation gonds de porte - pour ouvrant - Viti per fissaggio cardini e cerniere della porta - Schroef voor scharnier - Kruvi ukse polthingele		12	4x40	
HS13		Screw for door jamb - Schraube für türrahmen - Vis de fixation partie haute avec montants du cadre de porte - Viti x fissaggio montanti porte - Schroef voor deurkozijn - Kruvi ukse lengile		2	4x60	
HS16		Screw for door jamb - Schraube für türrahmen - Vis de fixation partie haute avec montants du cadre de porte - Viti x fissaggio montanti porte - Schroef voor deurkozijn - Kruvi ukse lengile		2	5x90	
HS25		Screw for doorstep - Schrauben für swelle - Vis pour fixation barre de seuil - Vite per soglia della porta - Schroef voor deurdorpel - Kruvi lävepakule		3	4.5x65	
		Male bolt hinge for door - Türband - Partie male de paumelle de porte - Cerniera anube x porta - Scharnier bout - Polthing adapteriga DIN15-57		4		
TL		Latch bolt for double door - Türriegel - Loquet pour double porte - Scrocco per porta doppia - Nachtslot - Riiv		2		
TL4		Door handle fittings - Türgriff - Poignée de porte - Maniglie - Deurhendel / klink - Ukse käepide		1		
TL5		Set of door lock covers - Schlossblenden - Set de garnitures de porte - Copertura serrature - Slot sluitplaat set - Ukse lukuplaat		1		
		Cylinder lock - Zylinderschloss - Barillet de porte - Serratura - Cylinder slot - Ukse lukusüdamik		1	30x30	

Glass size - Glasgröße - Taille de la vitre - Misura del vetro - Glas afmeting - Klaasi mõõt: 502x750 mm

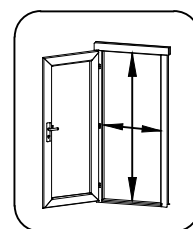

1418x1793

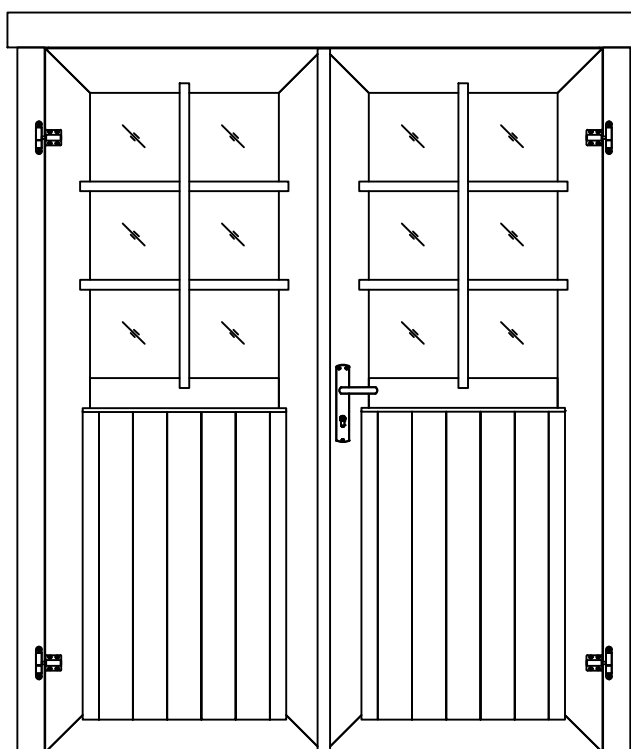

Allgemeine Montageanleitung - General assembly instructions - Instructions générales de montage

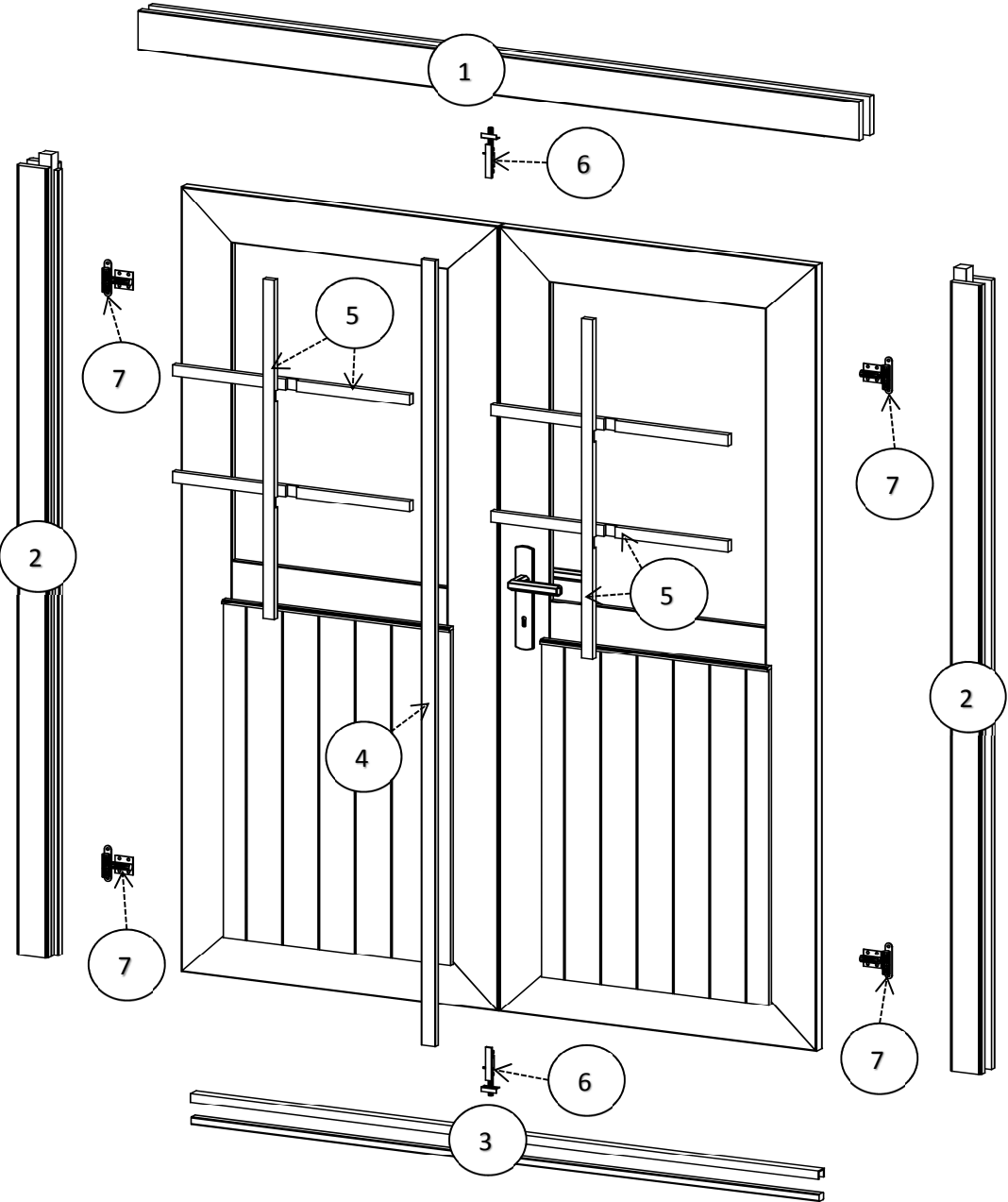

Pos	Piece list - Stückliste - Liste des pièces	Q.	P (mm)
1		1	66x100
2		2	66x80
3		1	19x20
4		1	13x32
5		6	15x25
6		2	
7		4	

