

Art. Nr. 2810250

1/6

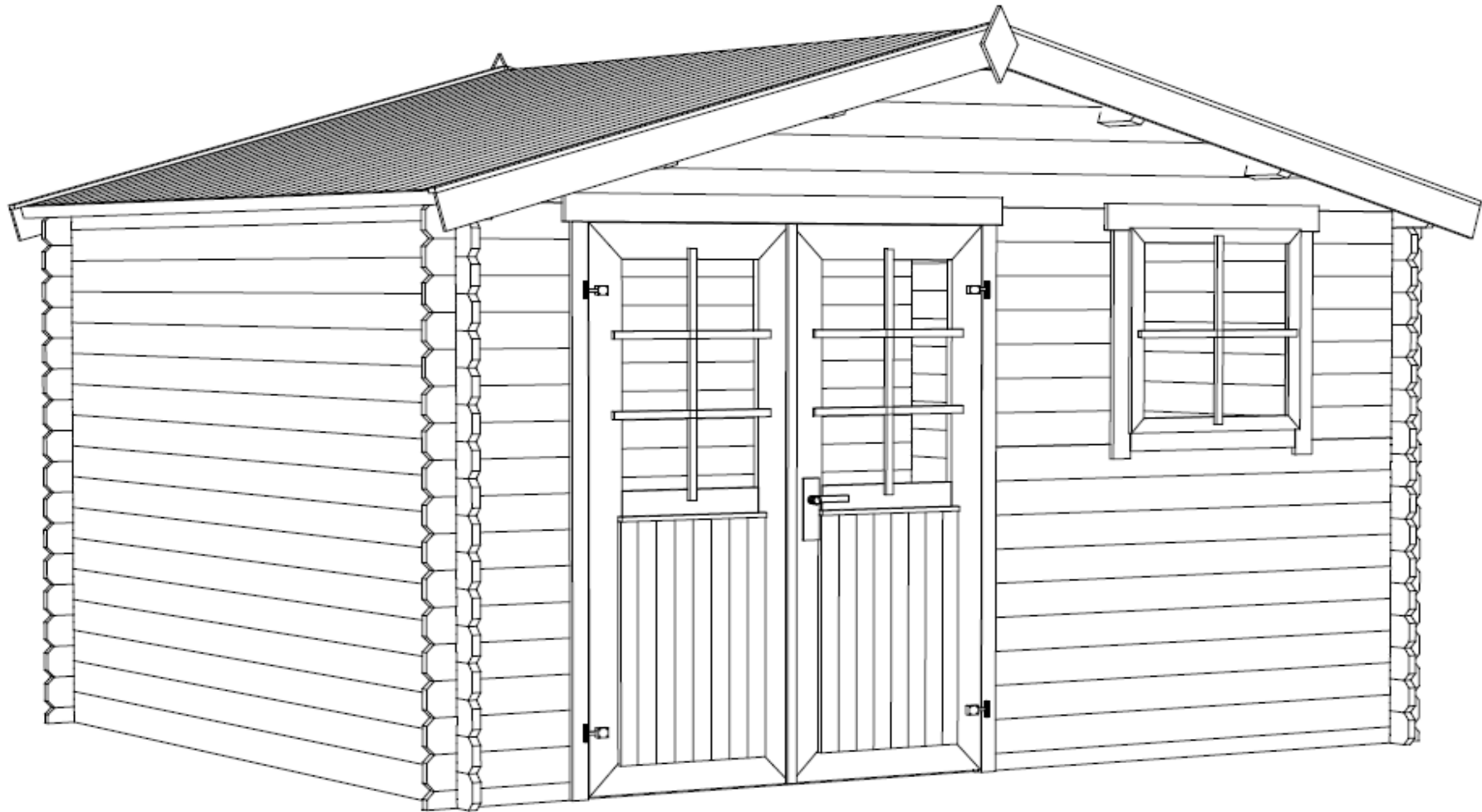

8.12.2014





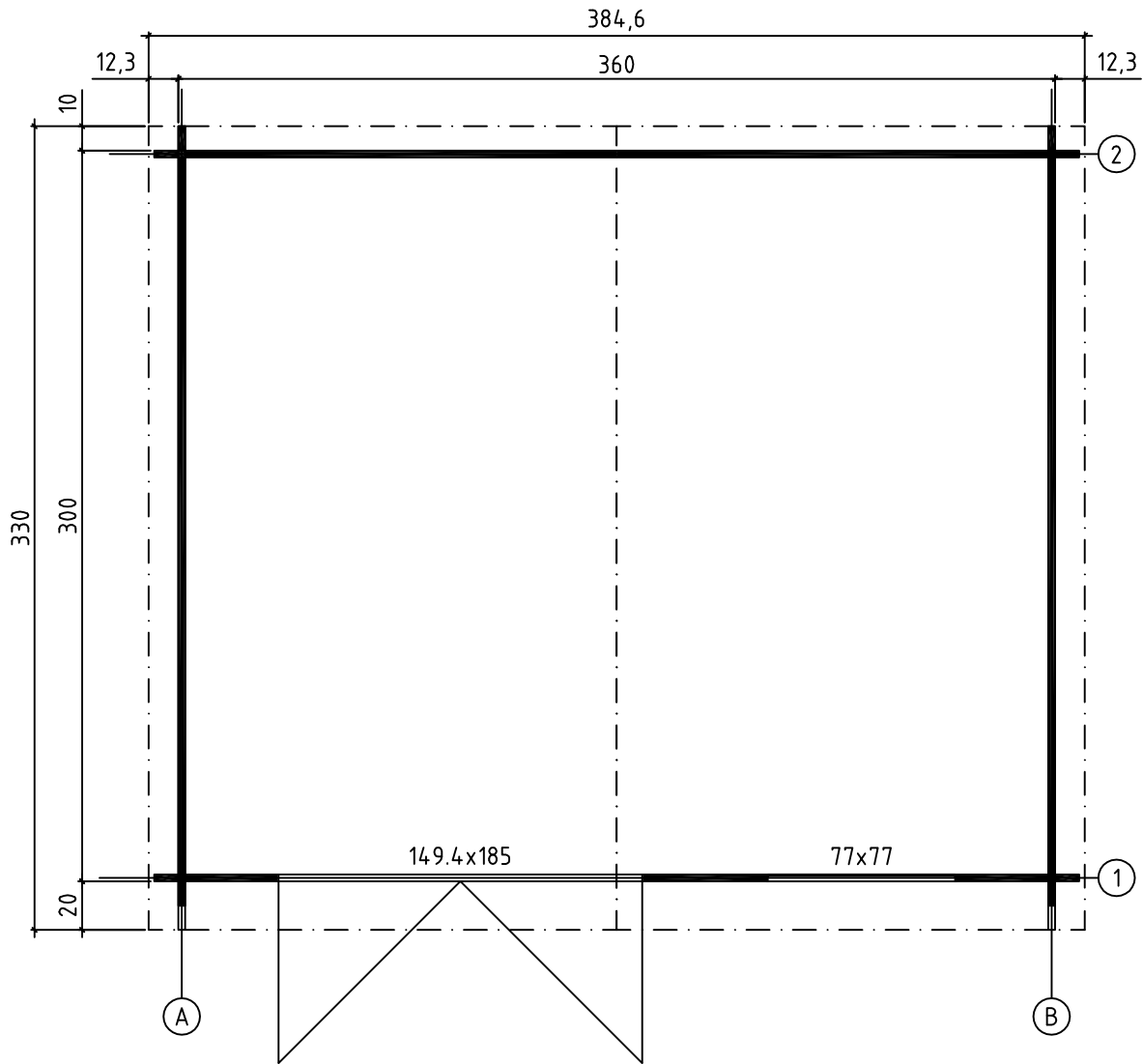



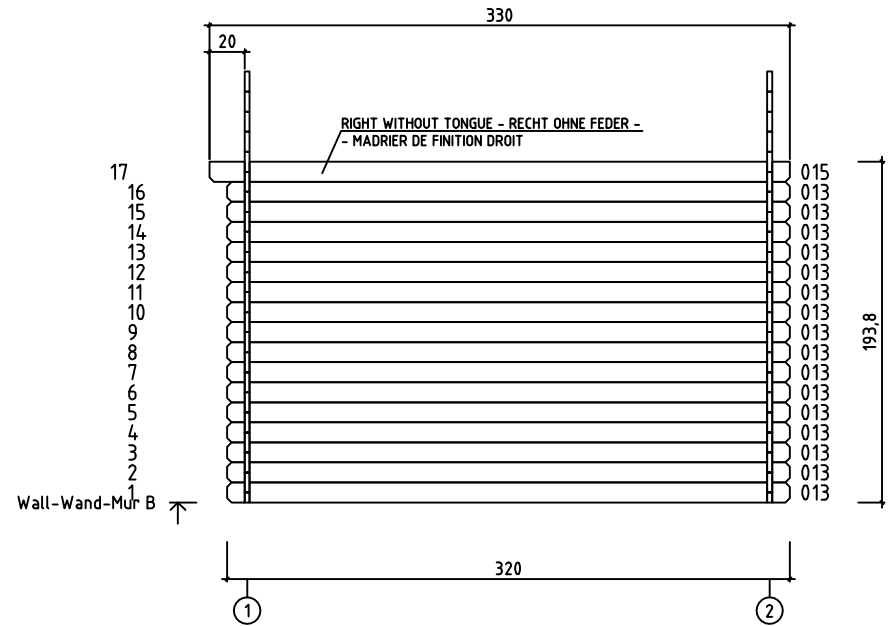
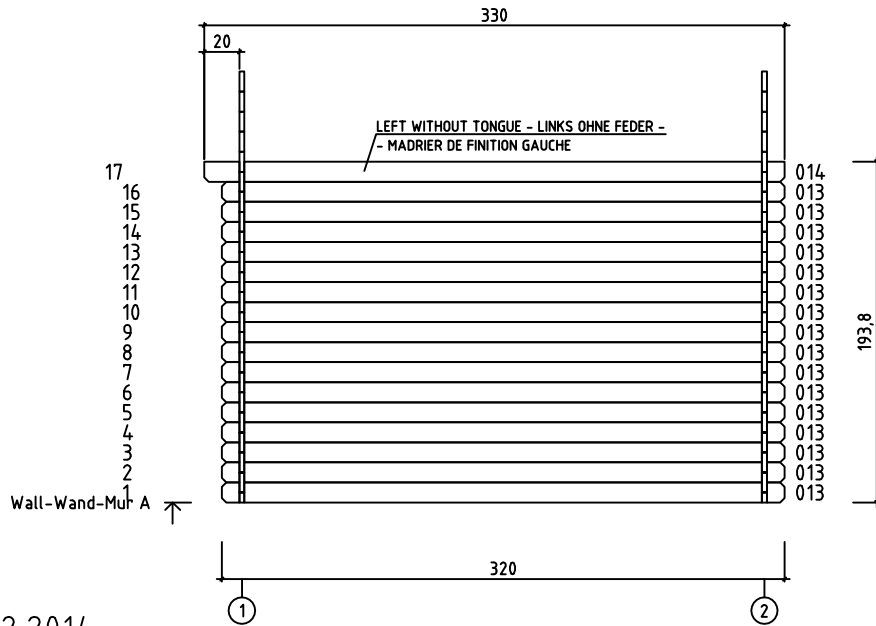
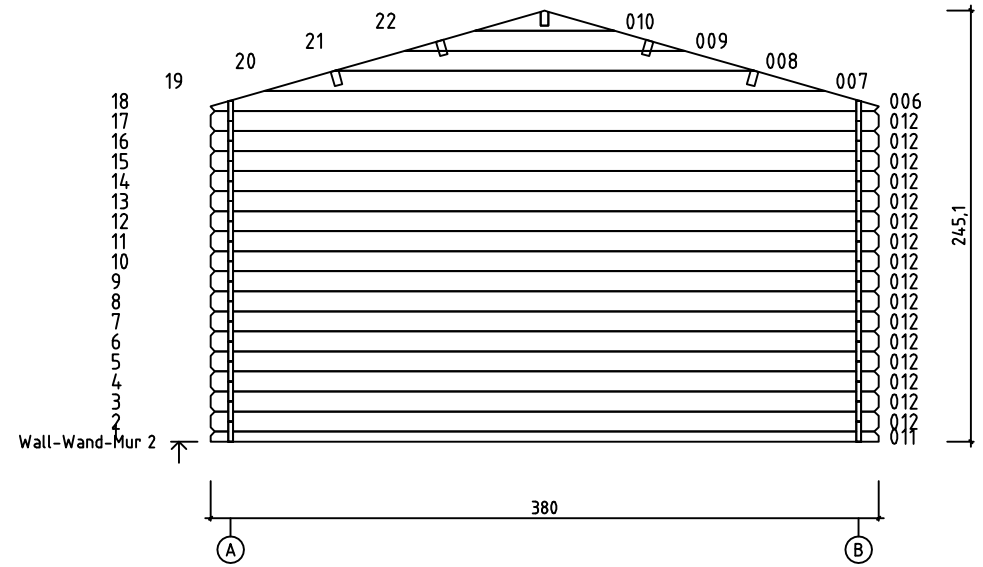
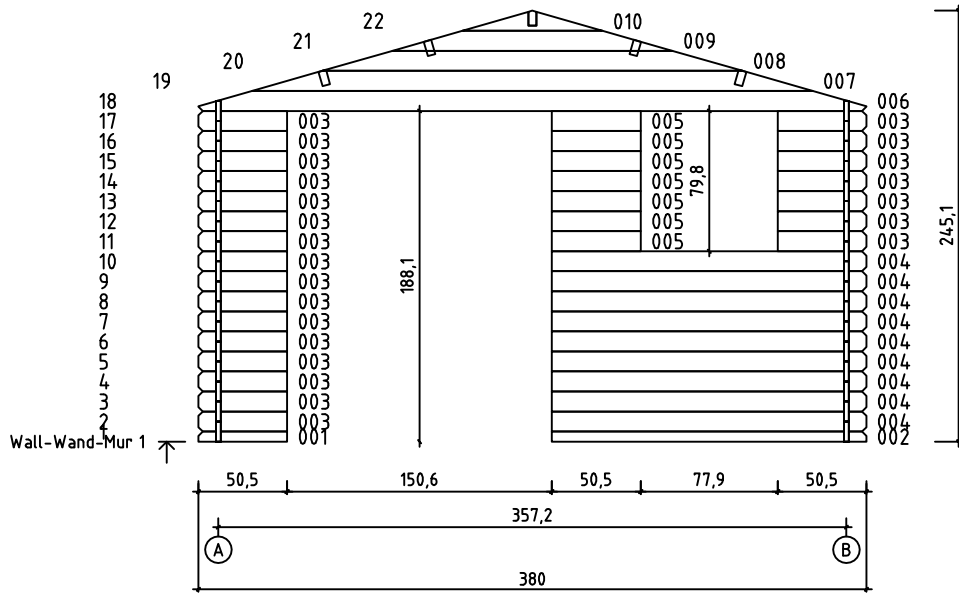

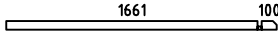
Art.Nr. 2810250

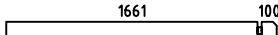

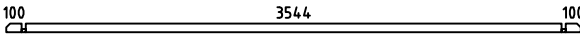
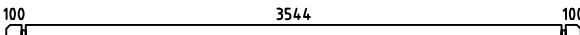
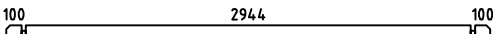
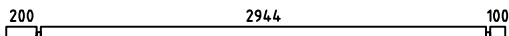
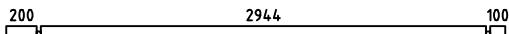
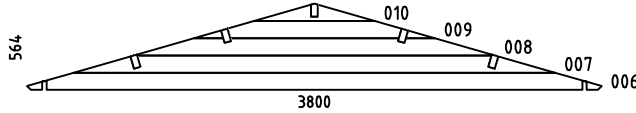
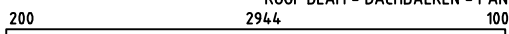
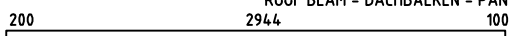

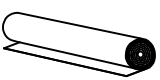

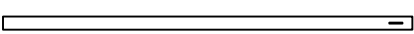
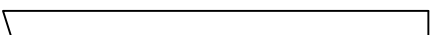
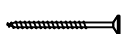

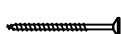

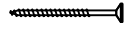

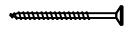
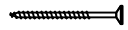
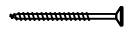
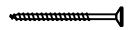
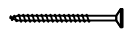
GROUNDPLAN - GRUNDPLAN - PLAN DE MASSE



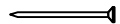

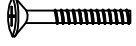
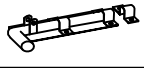

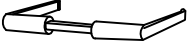
Art.Nr. 2810250

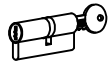
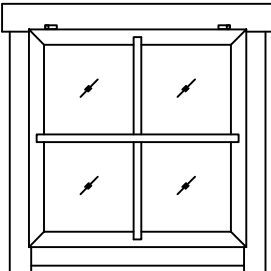

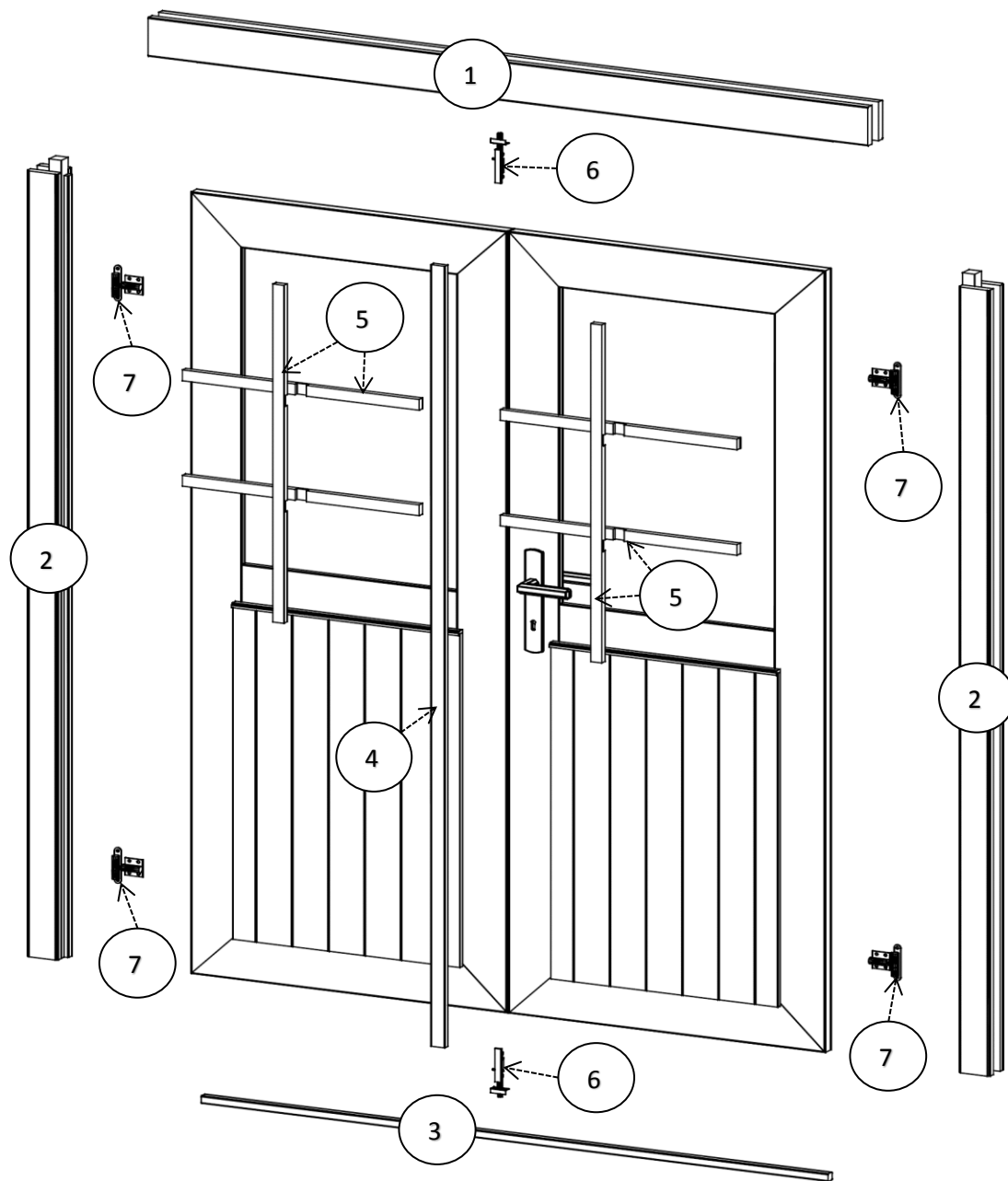
Pos	08.12.2014	Piecelist - Stücklist - Liste des composants Art.Nr. 2810250	4/6	Q.	P. (mm)	L. (mm)
001				1	28x57	505
002				1	28x57	1789
003				23	28x114	505
004				9	28x114	1789
005				7	28x114	505
011				1	28x57	3800
012				16	28x114	3800
013				32	28x114	3200
014				1	28x120	3300
015				1	28x120	3300
W1-1 W2-1				1 1		
PR1		ROOF BEAM - DACHBALKEN - PANNE DE TOIT		1	44x120	3300
APR1		ROOF BEAM - DACHBALKEN - PANNE DE TOIT		4	44x120	3300
	ROOF BOARDS - DACHBRETTER - VOLIGES			74	90x15	2000
	ROOFING FELT FILLET - DACHPAPPENLEISTE - BAGUETTE DE FIXATION DU FEUTRE BITUMEUX			4	15x45	2050
DPP-1	ROOFING FELT - DACHPAPPE - FEUTRE BITUMEUX		STRIP - BAHNEN - BANDE ROLLS / ROLLE / ROULEAUX	5 2		3400 15m2
	FASCIA BOARD - TRAUFBRETT - BANDEAU DE TOIT			2	15x45	3300
KFS-1	STORM PROTECTION - STURMLEISTE - - LATTE ANTI-TEMPETE			4	22x45	1900
	GABLE MOULDING - GIEBELLEISTE - - PLANCHE DE RIVE			4	15x120	2050
	SCREW FOR GEORGIAN BARS - SCHRAUBE FÜR SPROSSEN - VIS POUR FIXATION CROISILLONS BOIS DES MENUISERIES			16	2.5x20	
HS12	SCREW FOR GABLE SEGMENT - SCHRAUBEN FÜR DECKBLATT - VIS POUR FIXATION LOSANGE DE FINITION			4	3.5x35	
HS22	SCREW FOR FIXING DOOR TO THE WALL - SCHRAUBE ZUR BEFESTIGUNG TÜR - ZARGE MIT WAND - VIS POUR FIXATION DORMANT DE PORTE AU 1ER RANG DE MADRIER			2	3.5x50	
HS16	SCREW FOR GABLE MOULDING - SCHRAUBEN FÜR GIEBELLEISTE - VIS POUR FIXATION PLANCHE DE RIVE			32	3.5x50	

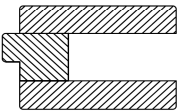
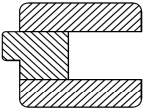
Pos	08.12.2014	Piecelist - Stücklist - Liste des composants Art.Nr. 2810250	5/6	Q.	P. (mm)	L. (mm)
HS3	SCREW FOR DOOR FILLET - SCHRAUBE ZUR BEFESTIGUNG TÜRLEISTE - VIS POUR FIXATION BAGUETTE D'ARRET DE PORTE		5	3x30		
HS56	SCREW FOR FIXING BOLT HINGE - SCHRAUBE FÜR TÜRRIEDEL - VIS POUR FIXATION GONDS DE PORTE - POUR OUVRANT		16	4x30		
HS32	SCREW FOR FASCIA BOARDS - SCHRAUBEN FÜR TRAUFBRETTEN - VIS POUR FIXATION BANDEAU DE TOIT		16	4x40		
HS58	SCREW FOR FIXING BOLT HINGE - SCHRAUBE FÜR TÜRRIEDEL - VIS POUR FIXATION GONDS DE PORTE - POUR OUVRANT		12	4x40		
HS43	SCREW FOR ROOF BEAMS - SCHRAUBEN FÜR DACHBALKEN - VIS POUR FIXATION PANNES DE TOIT		14	5x120		
HS41	SCREW FOR DOOR JAMB - SCHRAUBE FÜR TÜRRAHMEN - VIS POUR FIXATION MONTANT DE PORTE		2	5x90		
HS59	SCREW FOR DOORSTEP - SCHRAUBEN FÜR SWELLE - VIS POUR FIXATION BARRE DE SEUIL		3	4.5x65		
SH28	HAMMER BLOCK - SCHLAGHOLZ - CALLE DE FRAPPE		1			
SFS	NUT FOR STORM PROTECTION - SCHRAUBENMUTTER FÜR STURMLEISTE - ECROU POUR LATTE ANTI-TEMPETE		8	D6		
NF2	ZN NAIL FOR ROOF - ZN NÄGEL FÜR DACHBRETTEN - POINTE POUR FIXATION VOLIGES DE TOIT		316	2x50		
NFD	ZN NAIL FOR ROOFING FELT FILLET - ZN NÄGEL FÜR DACHPAPPENLEISTE - POINTE POUR BAGUETTE DE FIXATION FEUTRE BITUMEUX		20	2x40		
NF	ROOFING NAILS FOR ROOFING FELT - NÄGEL FÜR DACHPAPPE - POINTE POUR FIXATION FEUTRE BITUMEUX		138	2.8x15		
	MALE BOLT HINGE FOR DOOR - TÜRRIEDEL - PARTIE MALE DE PAUMELLE DE PORTE		4	DIN15-57		
BFS	BOLT FOR STORM PROTECTION - BOLZEN FÜR STURMLEISTE - BOULON POUR LATTE ANTI-TEMPETE		8	6x60		
TL	LATCH BOLT FOR DOUBLE DOOR - TORRIEDEL - LOQUET POUR DOUBLE PORTE		2			90
GS	GABLE SEGMENT - DECKBLATT - LOSANGE DE FINITION		2			
DFS	WASHER FOR STORM PROTECTION - DICHTSCHEIBE FÜR STURMLEISTE - RONDELLE POUR LATTE ANTI-TEMPETE		8	D6		
TL4	DOOR HANDLE FITTINGS - TÜRGRIF - POIGNEE DE PORTE		1			
TL5	SET OF DOOR LOCK COVERS - SCHLOSSBLENDEN - SET DE GARNITURES DE PORTE		1			
	CYLINDER LOCK - ZYLINDERSCHLOSS - BARILLET DE PORTE		1	30/30		
	WINDOW - FENSTER - FENETRE 770x770 SGC	AK.1.104.SVA.c	1			
						

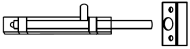
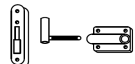

Pos	Piece list - Stückliste - Liste des pièces	Q.	P (mm)
1		1	66x100
2		2	66x80
3		1	18x18
4		1	13x32
5		6	15x25
6		2	
7		4	

