

Art. Nr. 2825450

1/7



26.10.2015

Art. Nr. 2825450

GROUNDPLAN - GRUNDPLAN - PLAN DE MASSE

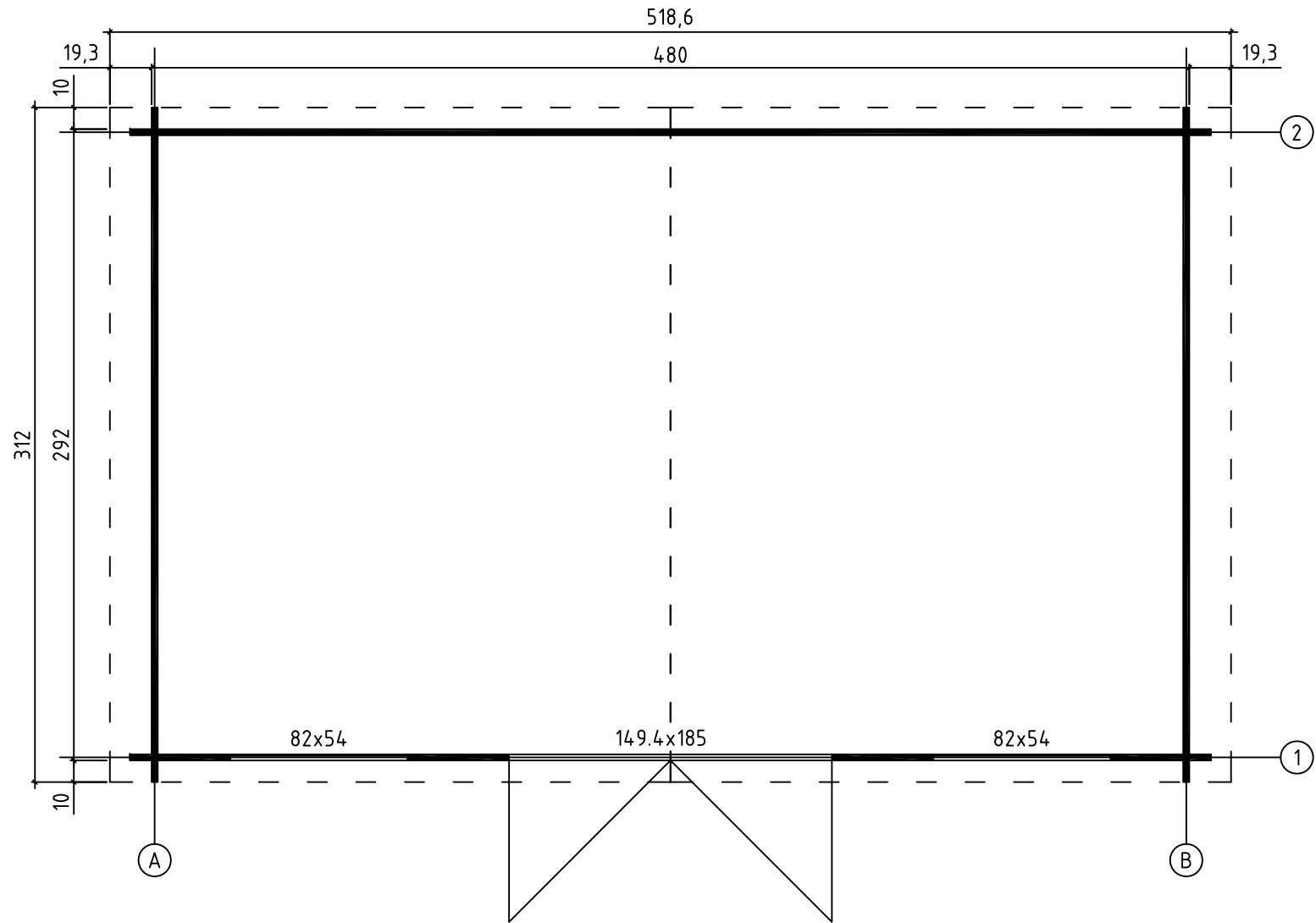



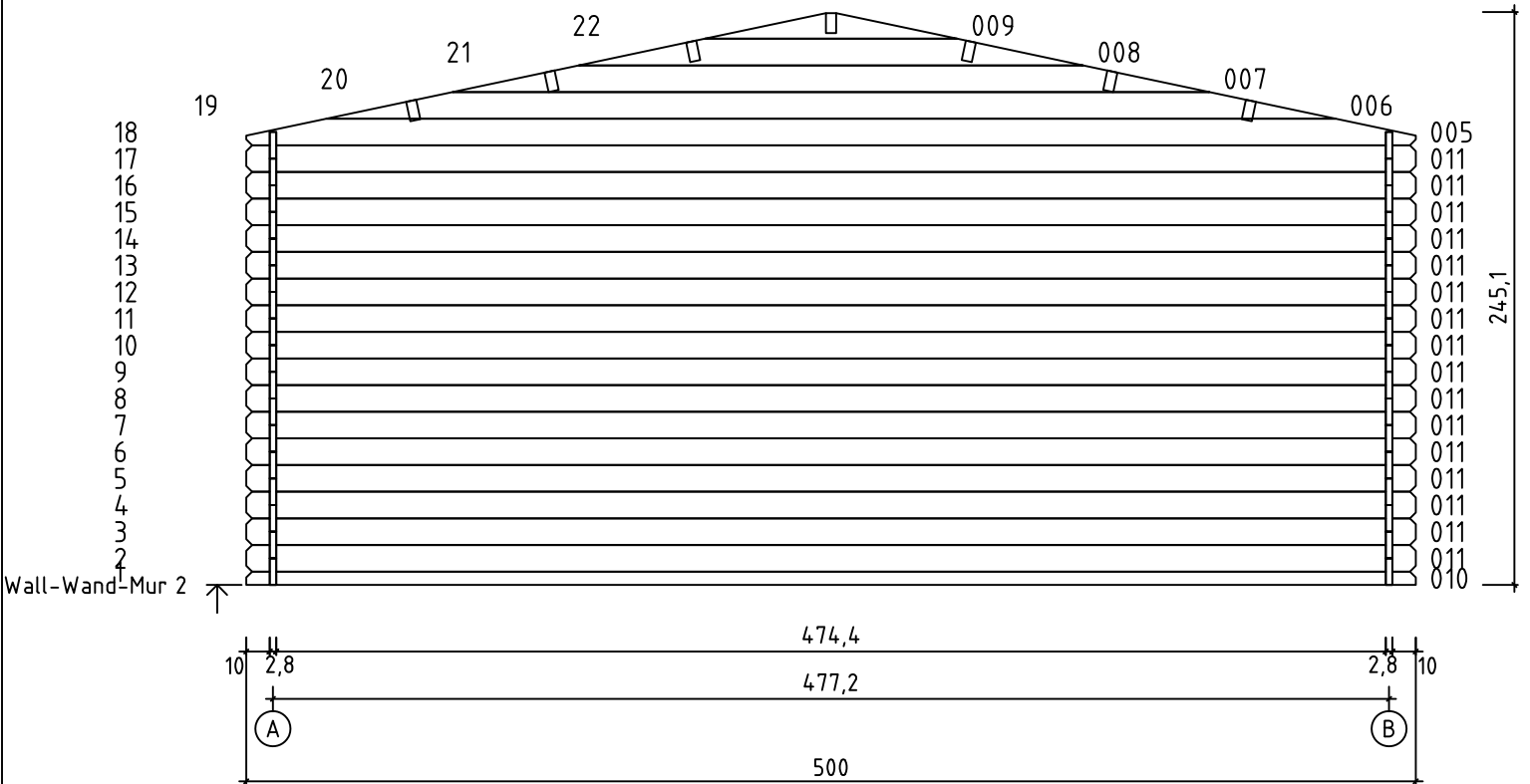
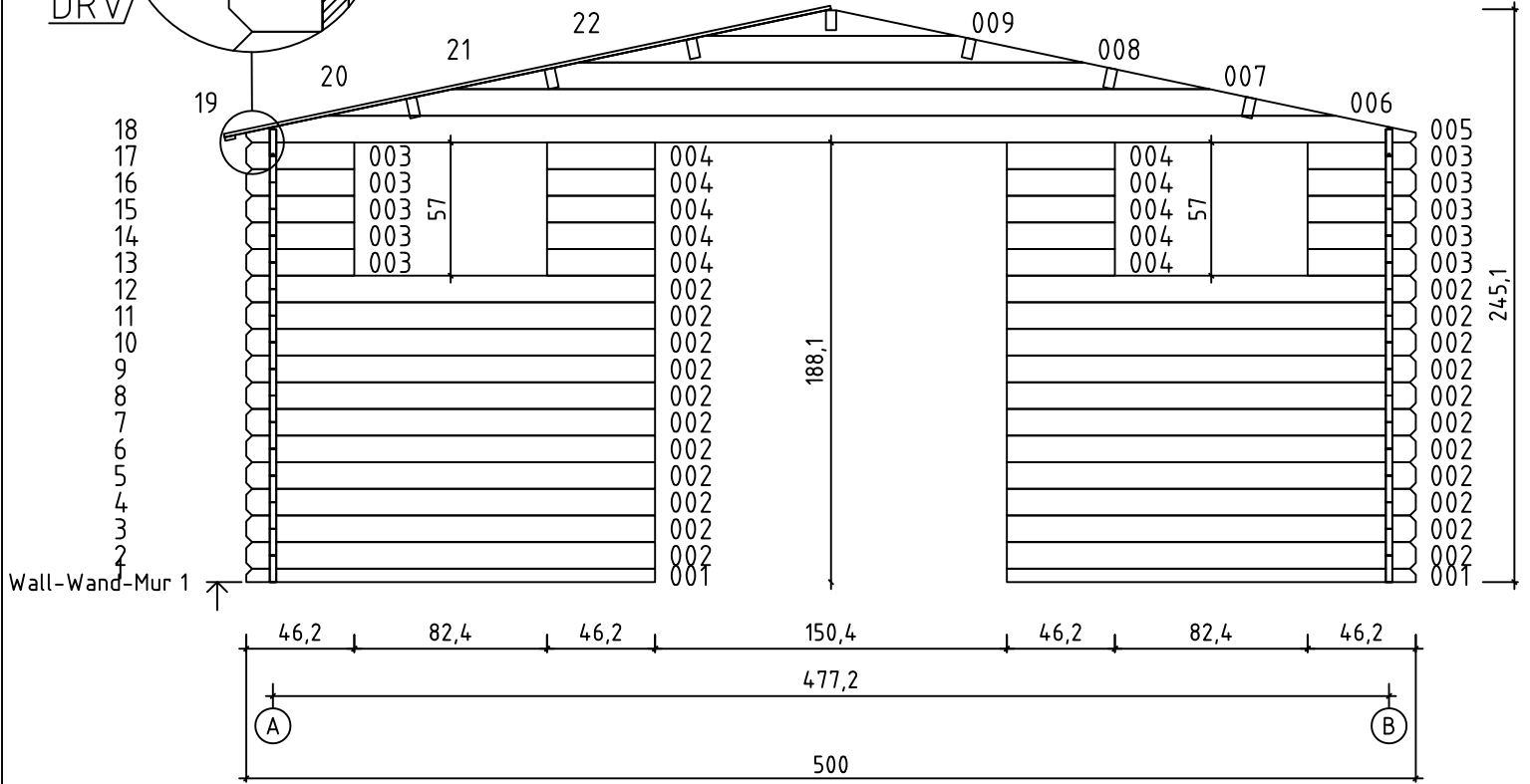
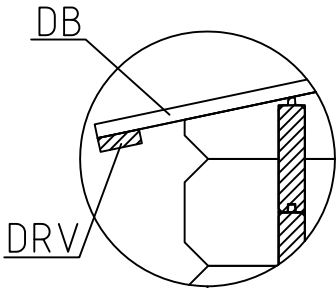



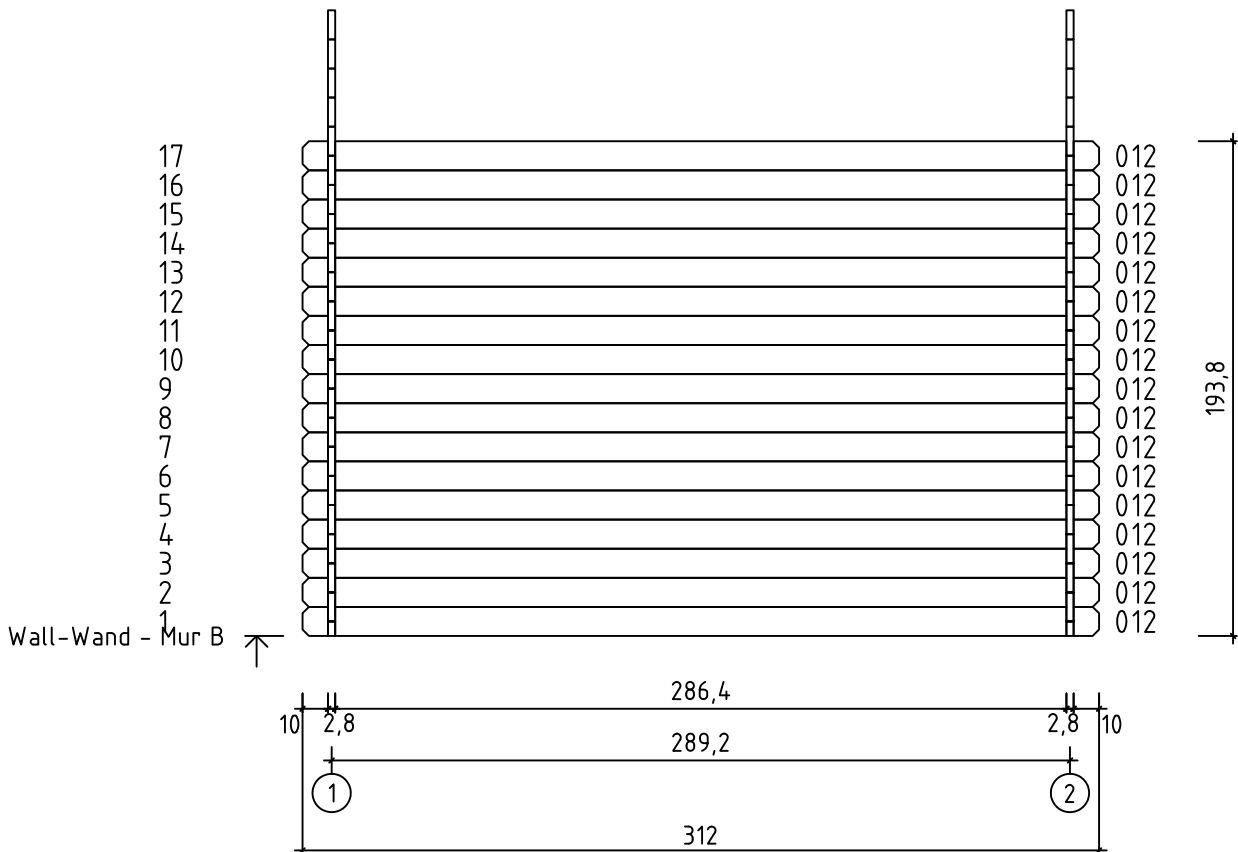
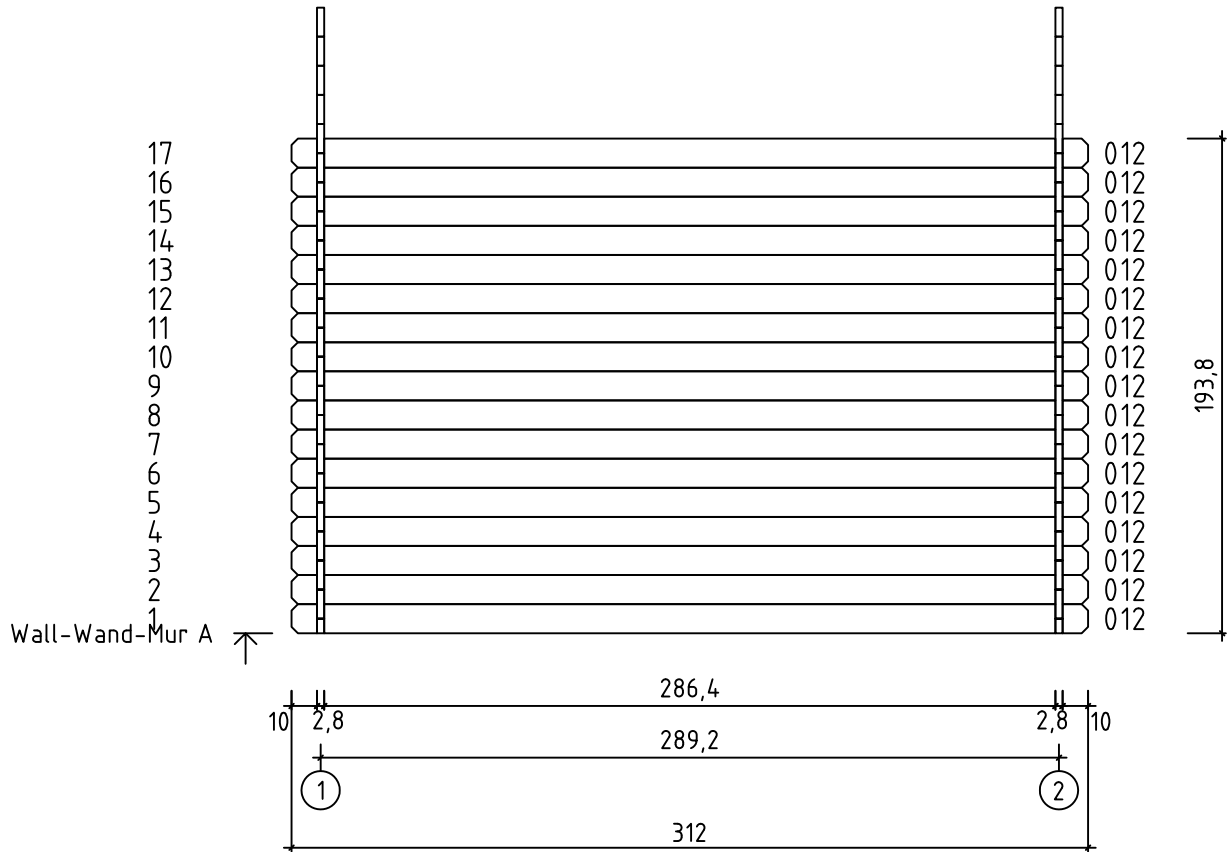

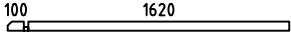
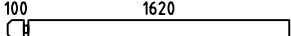

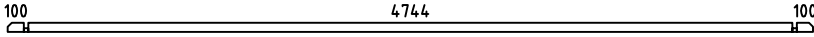
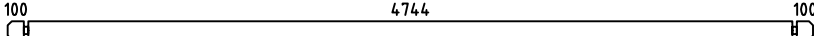
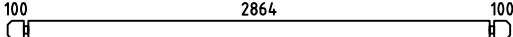
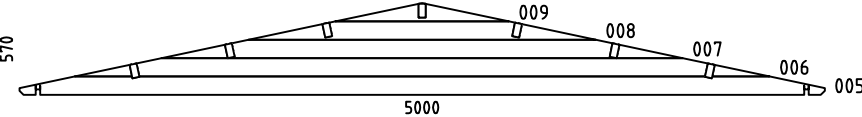
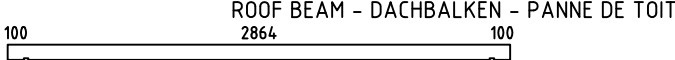

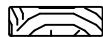
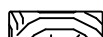
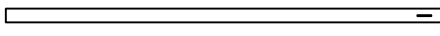
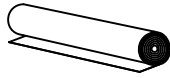
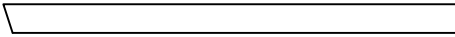

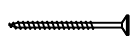



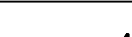
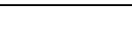

Art. Nr. 2825450

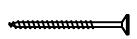

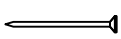
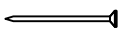
Art. Nr. 2825450

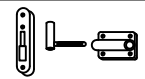
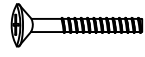
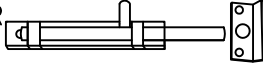

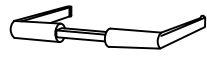

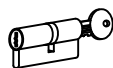
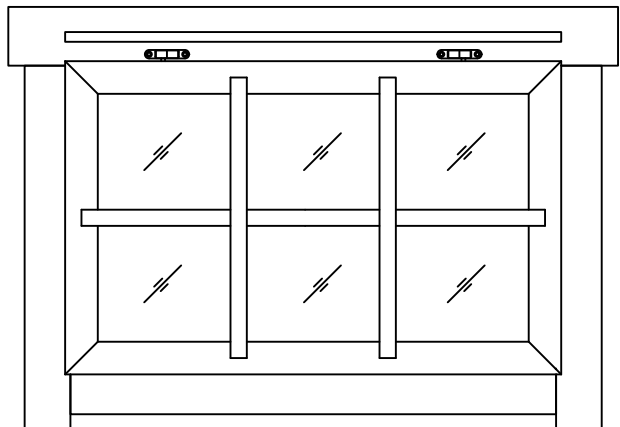

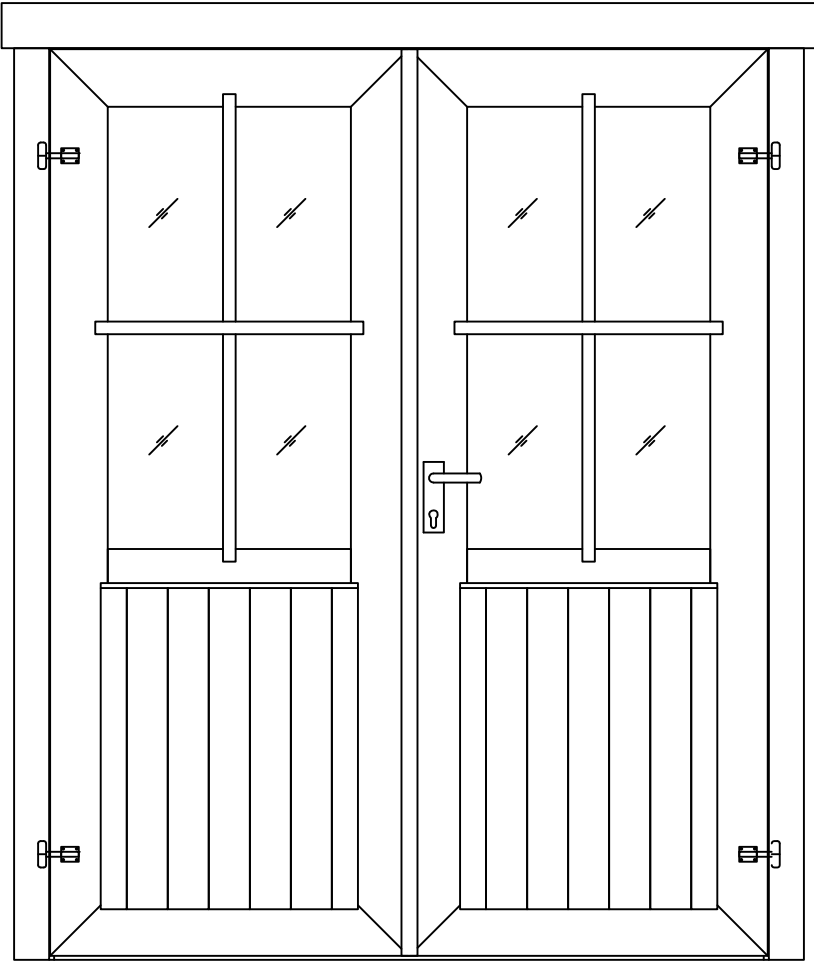
Pos	26.10.2015	Piecelist - Stücklist - Liste des composants Art. Nr. 2825450	5/7	Q.	P (mm)	L (mm)
001				2	28x57	1748
002				22	28x114	1748
003				10	28x114	462
004				10	28x114	462
010				1	28x57	5000
011				16	28x114	5000
012				34	28x114	3120
W1-1 W2-1				1 1		
A-PR1				7	44x95	3120
DB	ROOF BOARDS - DACHBRETTER - VOLIGES			70	90x15	2650
	ROOFING FELT FILLET - DACHPAPPENLEISTE - BAGUETTE DE FIXATION DU FEUTRE BITUMEUX			4	15x45	2700
DRV	ROOF EDGE REINFORCEMENT - DACHRANDVERSTÄRKUNG - CORNIERE DE RENFORT DE BORD DE TOIT			2	15x45	3120
KFS	STORM PROTECTION - STURMLEISTE - LATTE ANTI-TEMPETE			4	22x45	1880
	ROOFING FELT (STRIP) - DACHPAPPE (BAHNEN) - FEUTRE BITUMEUX (BANDE)			6		3220
	GABLE MOULDING - GIEBELLEISTE - PLANCHE DE RIVE			4	15x120	2700
	SCREW FOR GEORGIAN BARS - SCHRAUBE FÜR SPROSSEN - VIS DE BARRES GEORGIENNE			20	2.5x20	
HS12	SCREW FOR GABLE SEGMENT - SCHRAUBEN FÜR DECKBLATT - VIS POUR FIXATION LOSANGE DE FINITION			4	3.5x35	
HS22	SCREW FOR FIXING DOOR TO THE WALL - SCHRAUBE ZUR BEFESTIGUNG TÜR - ZARGE MIT WAND - VIS POUR FIXATION DORMANT DE PORTE AU 1ER RANG DE MADRIER			2	3.5x50	
HS16	SCREW FOR GABLE MOULDING - SCHRAUBEN FÜR GIEBELLEISTE - VIS POUR FIXATION PLANCHE DE RIVE			40	3.5x50	
HS59	SCREW FOR DOORSTEP - SCHRAUBEN FÜR SWELLE - VIS POUR FIXATION BARRE DE SEUIL			3	3x30	
	SCREW FOR ROOF EDGE REINFORCEMENT - SCHRAUBEN FÜR DACHRANDVERSTÄRKUNG - VIS POUR FIXATION CORNIERE RENFORT DE BORD DE TOIT			14	3x30	
HS3	SCREW FOR DOOR FILLET - SCHRAUBE ZUR BEFESTIGUNG TÜRLEISTE - VIS POUR FIXATION BAGUETTE D'ARRET DE PORTE			5	3x30	
HS56	SCREW FOR FIXING BOLT HINGE - SCHRAUBE FÜR TÜRRIGEL - VIS POUR FIXATION GONDS DE PORTE - POUR OUVRANT			16	4x30	
HS58	SCREW FOR FIXING BOLT HINGE - SCHRAUBE FÜR TÜRRIGEL - VIS POUR FIXATION GONDS DE PORTE - POUR OUVRANT			12	4x40	

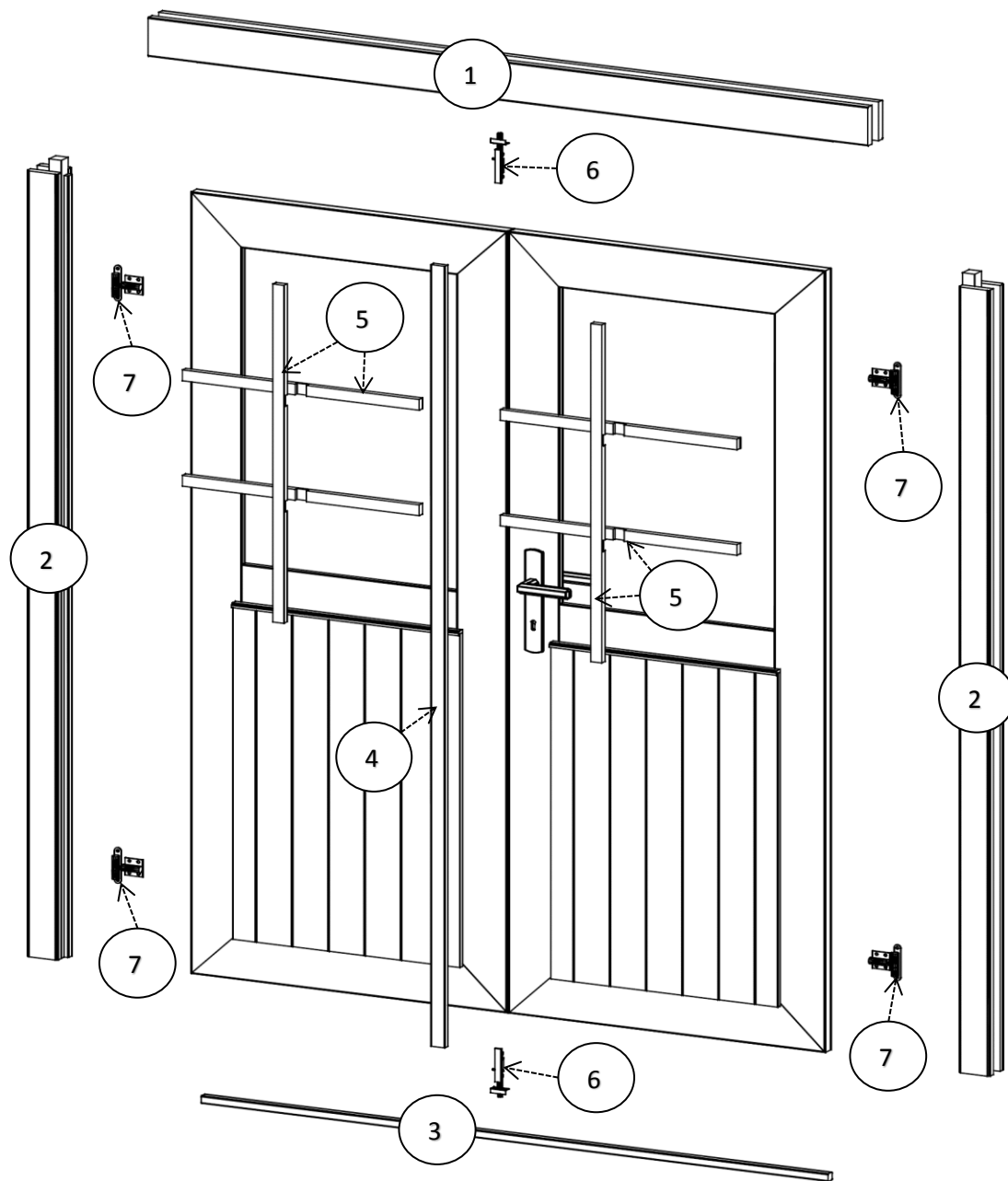
Pos	26.10.2015	Piecelist - Stücklist - Liste des composants Art. Nr. 2825450	6/7	Q.	P (mm)	L (mm)
HS41	SCREW FOR DOOR JAMB - SCHRAUBE FÜR TÜRRAHMEN - VIS POUR FIXATION MONTANT DE PORTE			2	4x60	
HS43	SCREW FOR ROOF BEAMS - SCHRAUBEN FÜR DACHBALKEN - VIS POUR FIXATION PANNES DE TOIT			18	5x120	
HS41	SCREW FOR DOOR JAMB - SCHRAUBE FÜR TÜRRAHMEN - VIS POUR FIXATION MONTANT DE PORTE			2	5x90	
SH28	HAMMER BLOCK - SCHLAGHOLZ - CALLE DE FRAPPE			1		
SFS	NUT FOR STORM PROTECTION - SCHRAUBENMUTTER FÜR STURMLEISTE - ECROU POUR LATTE ANTI-TEMPETE			8	D6	
NF2	ZN NAIL FOR ROOF - ZN NÄGEL FÜR DACHBRETT - POINTE POUR FIXATION VOLIGES DE TOIT			376	2x50	
NFD	ZN NAIL FOR ROOFING FELT FILLET - ZN NÄGEL FÜR DACHPAPPENLEISTE - POINTE POUR BAGUETTE DE FIXATION FEUTRE BITUMEUX			28	2x40	
NF	ROOFING NAILS FOR ROOFING FELT - NÄGEL FÜR DACHPAPPE - POINTE POUR FIXATION FEUTRE BITUMEUX			154	2.8x15	
	MALE BOLT HINGE FOR DOOR - TÜRRIEGEL - PARTIE MALE DE PAUMELLE DE PORTE			4	DIN15-57	
BFS	BOLT FOR STORM PROTECTION - BOLZEN FÜR STURMLEISTE - BOULON POUR LATTE ANTI-TEMPETE			8	6x60	
TL	LATCH BOLT FOR DOUBLE DOOR - TORRIEGEL - LOQUET POUR DOUBLE PORTE			2		90
GS	GABLE SEGMENT - DECKBLATT - LOSANGE DE FINITION			2		
DFS	WASHER FOR STORM PROTECTION - DICHTSCHEIBE FÜR STURMLEISTE - RONDELLE POUR LATTE ANTI-TEMPETE			8	D6	
TL4	DOOR HANDLE FITTINGS - TÜRRGRIFF - POIGNEE DE PORTE			1		
TL5	SET OF DOOR LOCK COVERS - SCHLOSSBLENDEN - SET DE GARNITURES DE PORTE			1		
	CYLINDER LOCK - ZYLINDERSCHLOSS - BARILLET DE PORTE			1	30/30	
	WINDOW - FENSTER - FENETRE 820x540 SGC	AK.1.106.SVA.h		2		
						

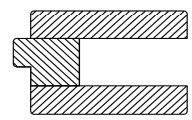
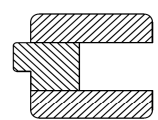
Pos	26.10.2015	Piecelist - Stücklist - Liste des composants Art. Nr. 2825450	7/7	Q.	P (mm)	L (mm)
	DOOR - TÜR - PORTE 14.94x1850 SGA+28	TUK.2.044.SVP.MX28	1			
 <p>The drawing shows a front view of a double door. Each door has a glass panel with a vertical muntin bar in the center. The glass is divided into four quadrants by the muntin bar and a horizontal bar. The bottom section of each door is filled with vertical slats. There are four hinges: two on the top edge and two on the bottom edge. A handle and lock mechanism are located on the right-hand door.</p>						

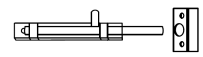
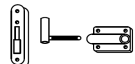

Pos	Piece list - Stückliste - Liste des pièces	Q.	P (mm)
1		1	66x100
2		2	66x80
3		1	18x18
4		1	13x32
5		6	15x25
6		2	
7		4	

