

Matterhorn 5.4x7.4

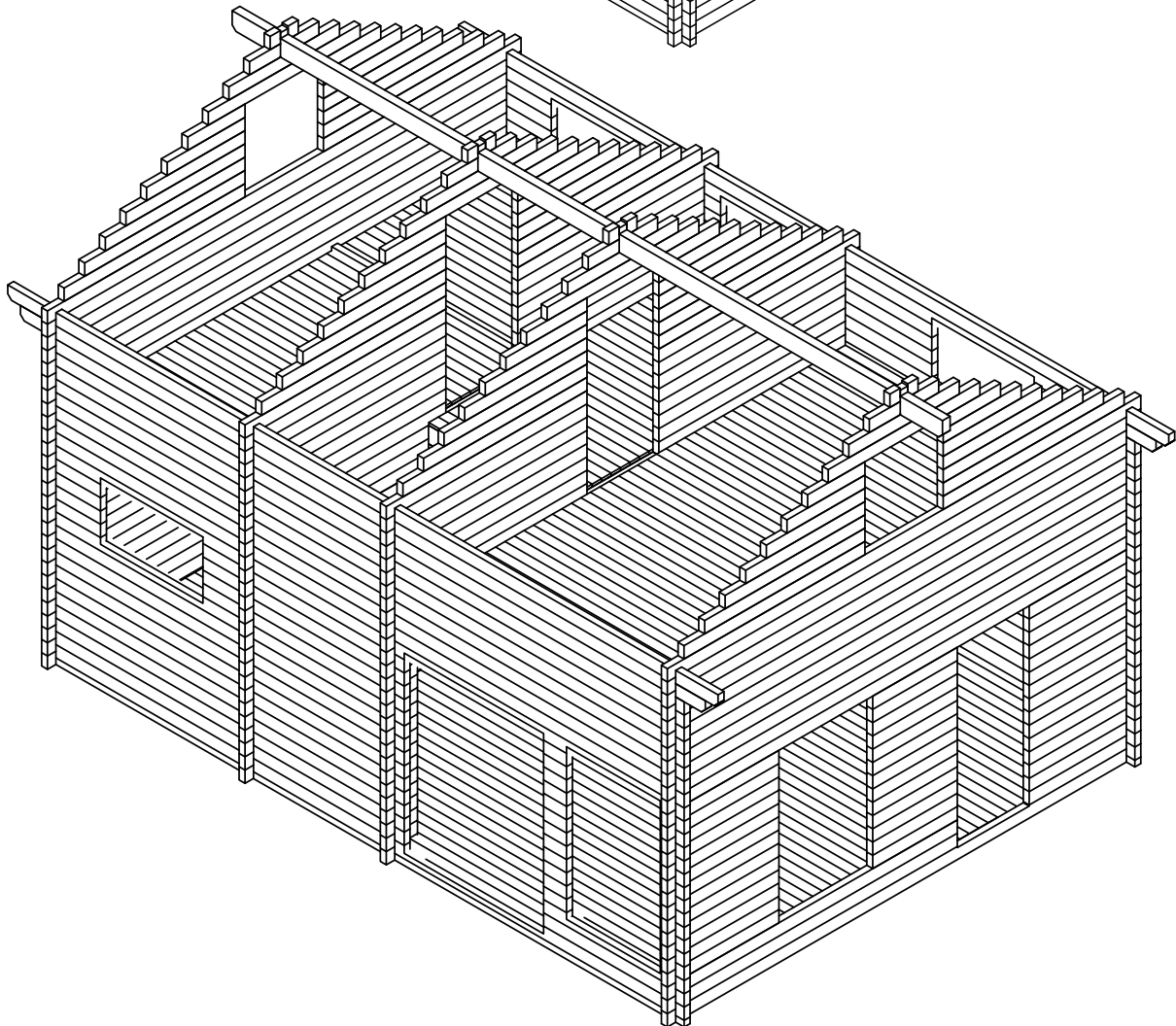

Matterhorn 5.4x7.4
GRUNDPLAN ERDGESCHLOSS

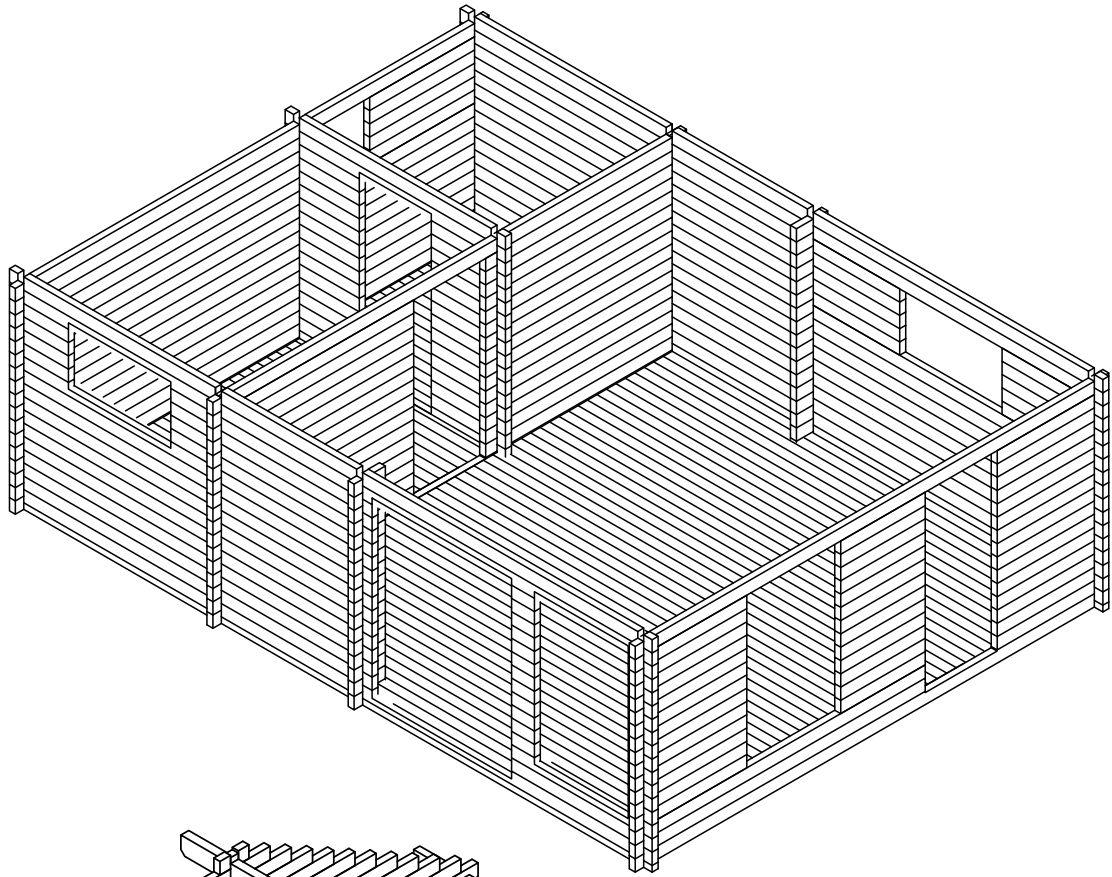
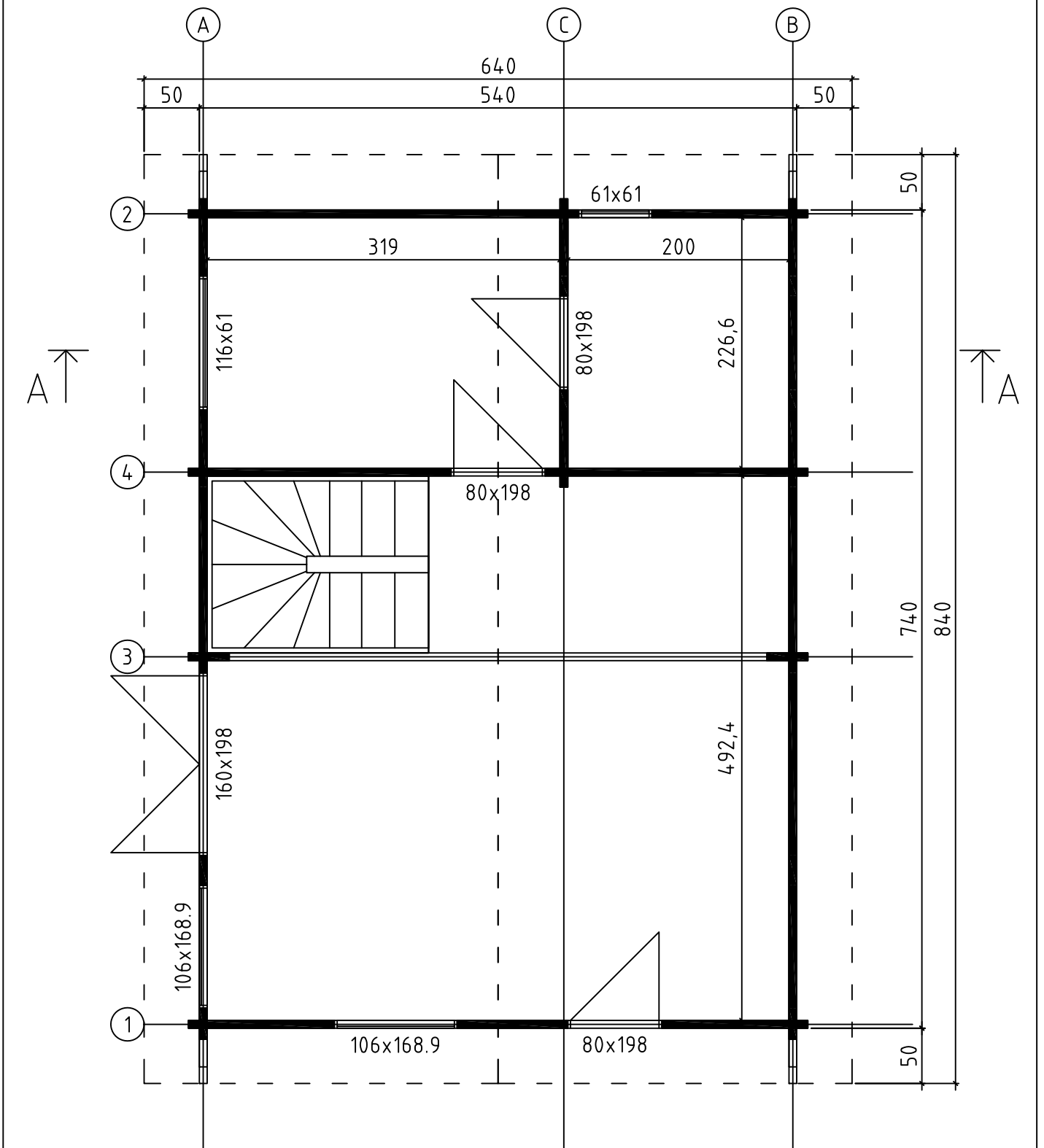

Matterhorn 5.4x7.4
GRUNDPLAN ERSTE STOCK

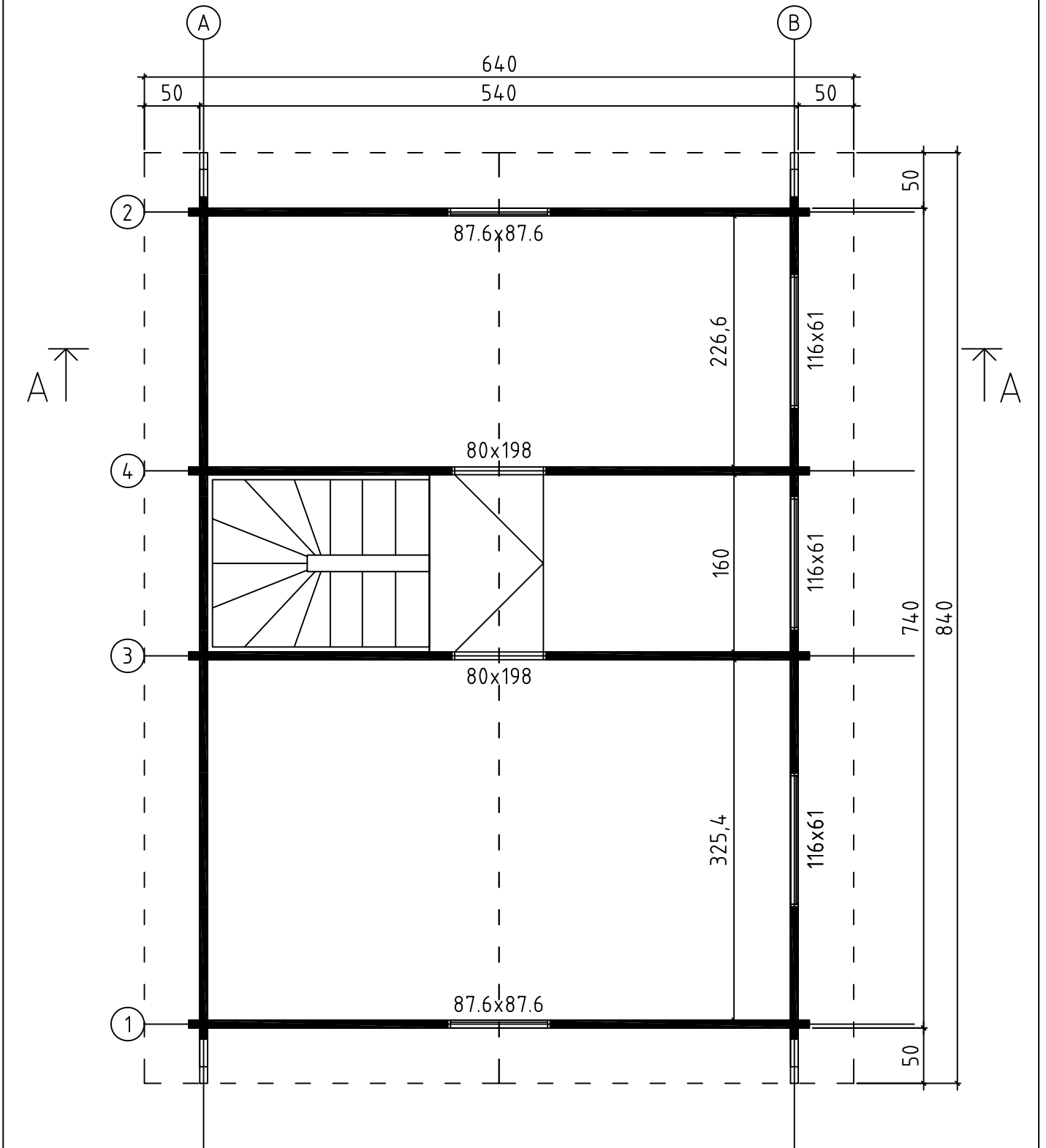

Matterhorn 5.4x7.4
DACHSPARREN

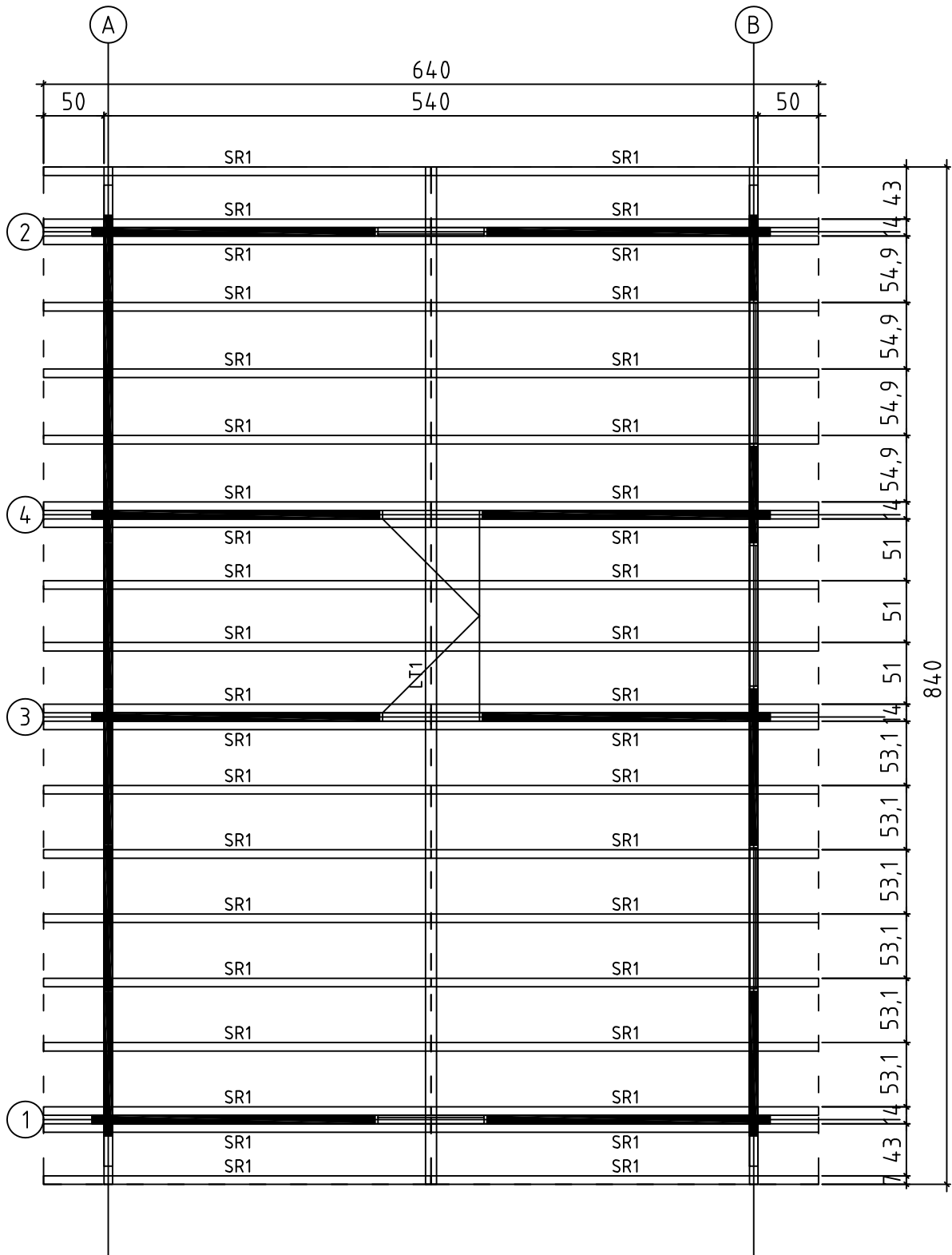

Matterhorn 5.4x7.4
HALBGESCHOSS BALKEN

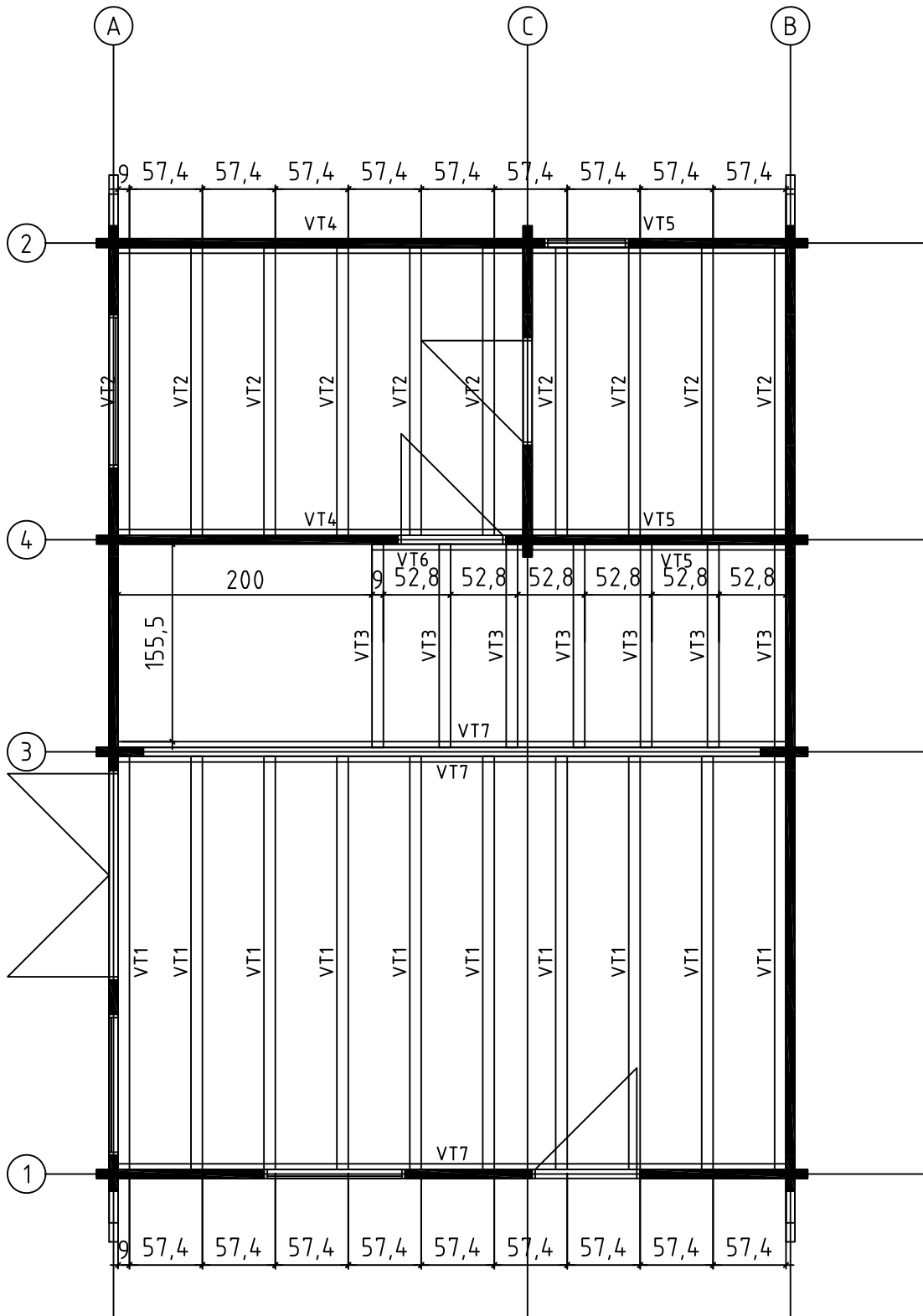

Matterhorn 5.4x7.4
FUSSBODENBRETTER ERDGESCHLOSS

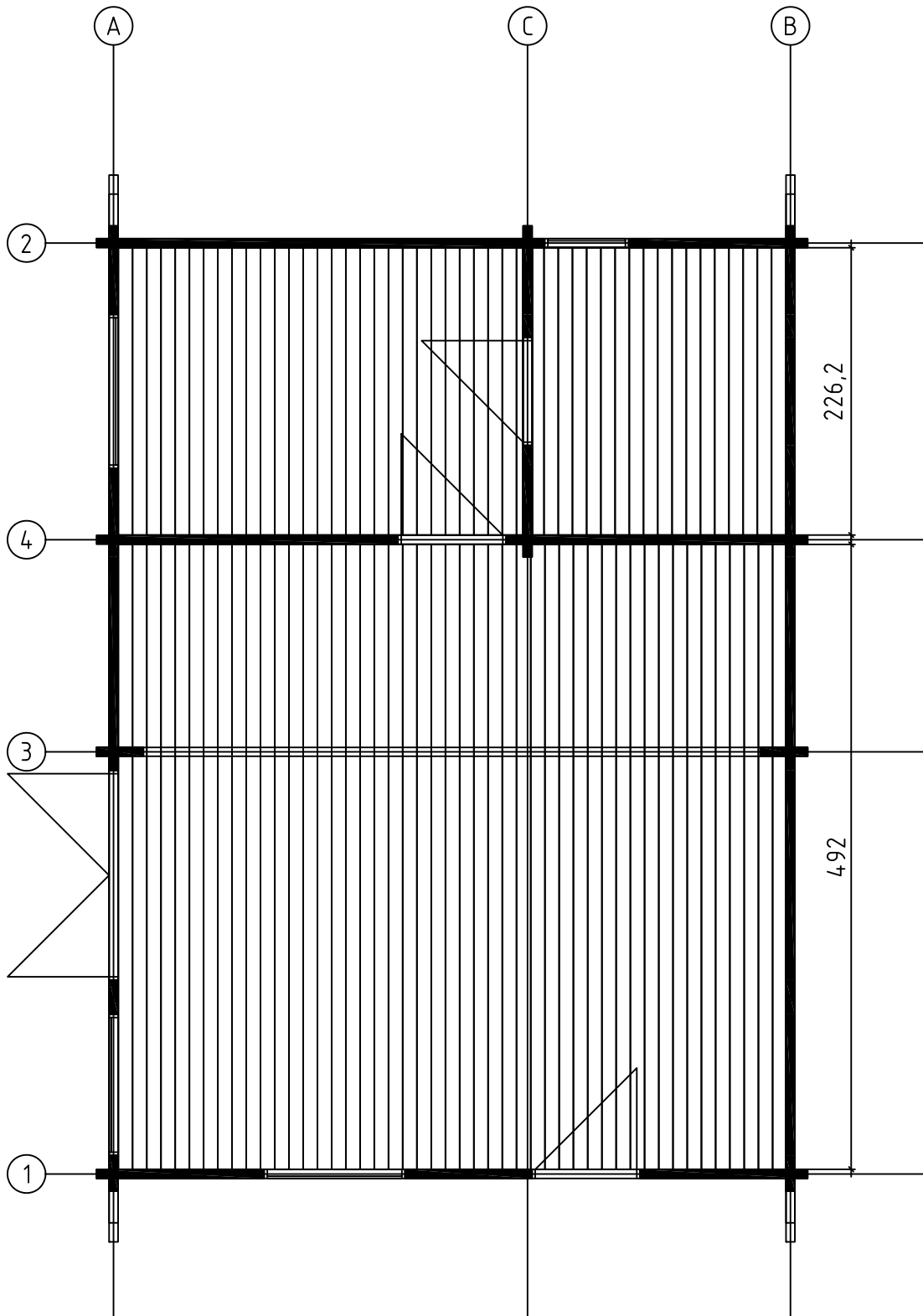

Matterhorn 5.4x7.4
FUSSBODENBRETTER ERSTE STOCK

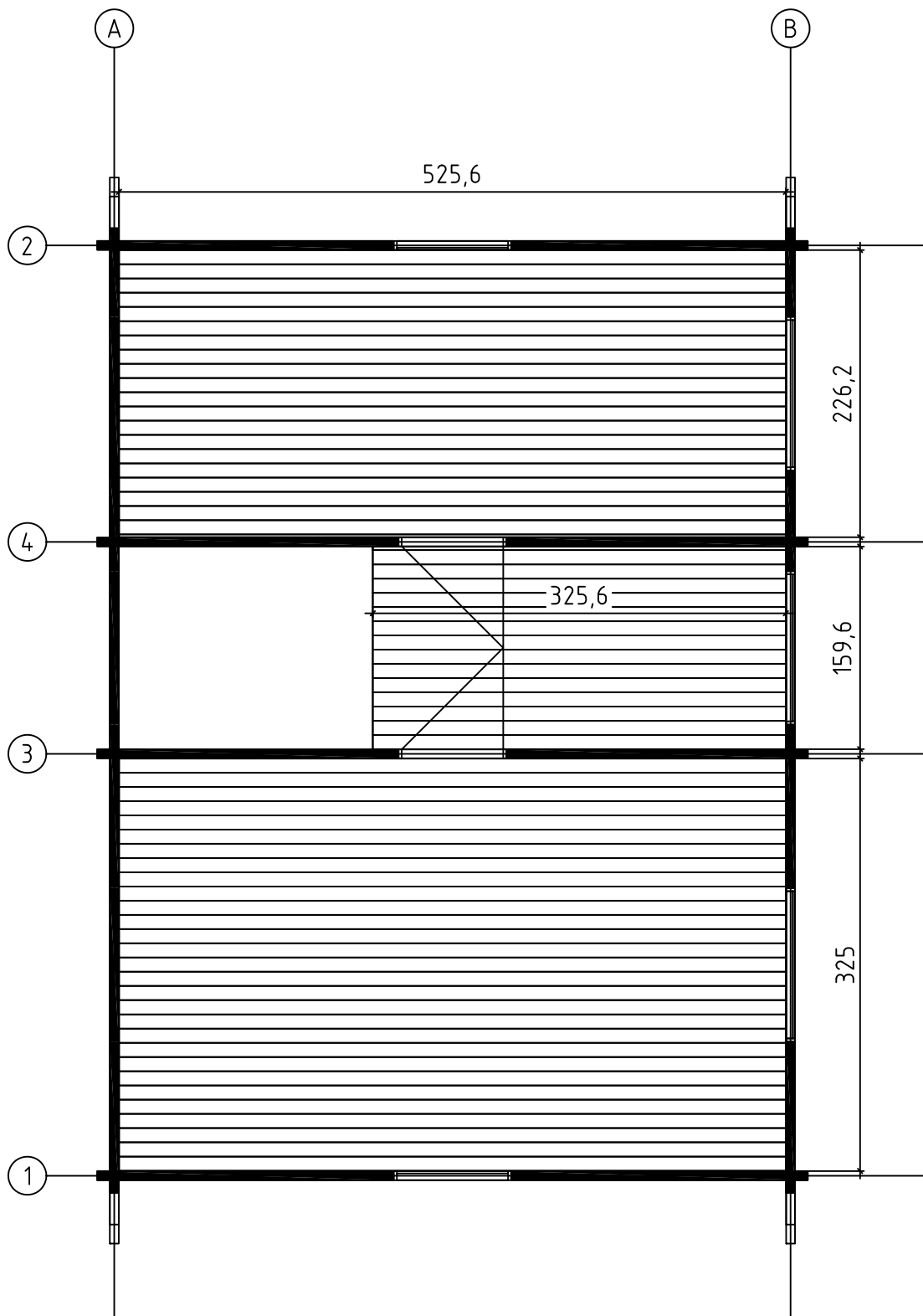

Matterhorn 5.4x7.4

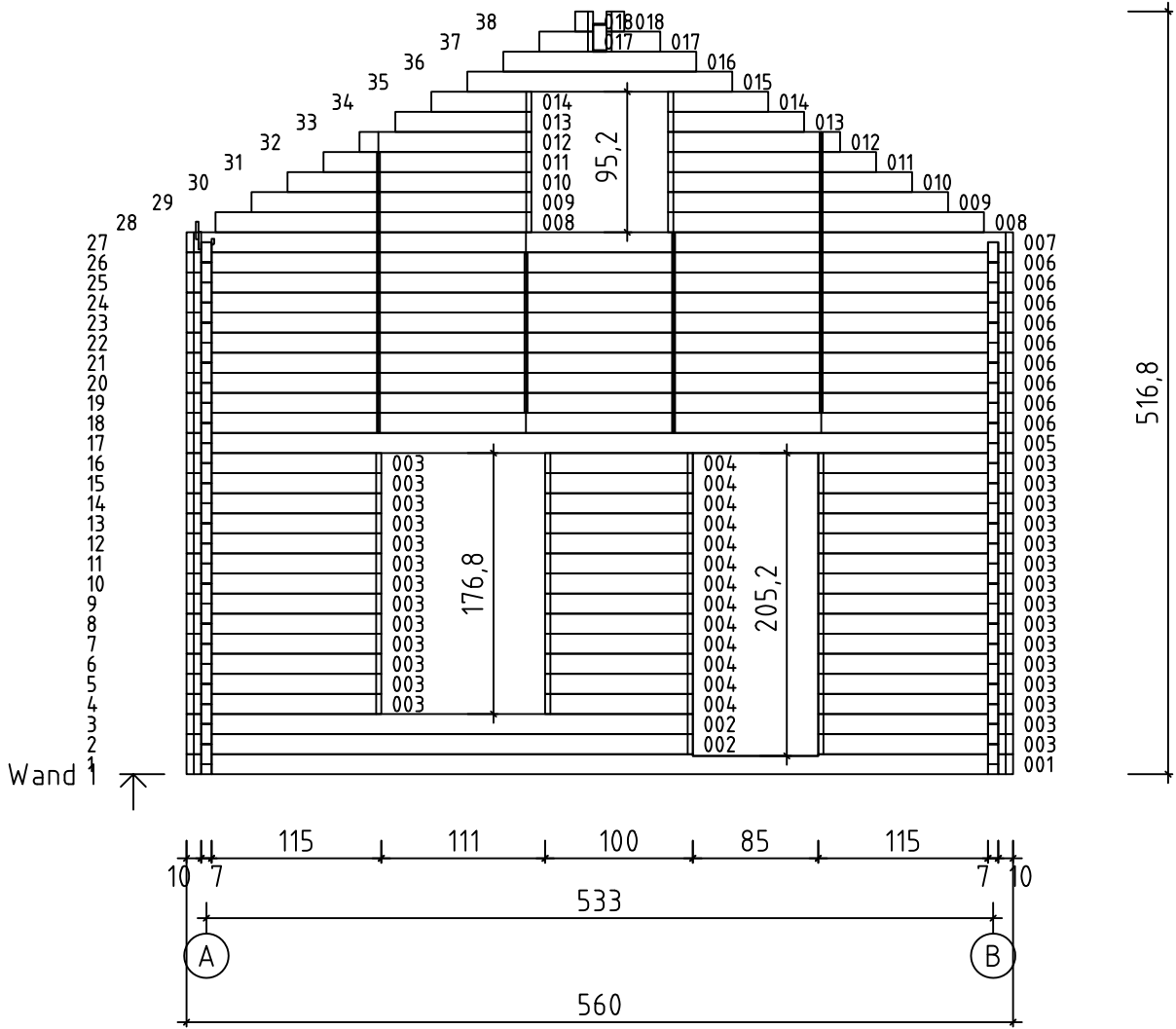

Matterhorn 5.4x7.4

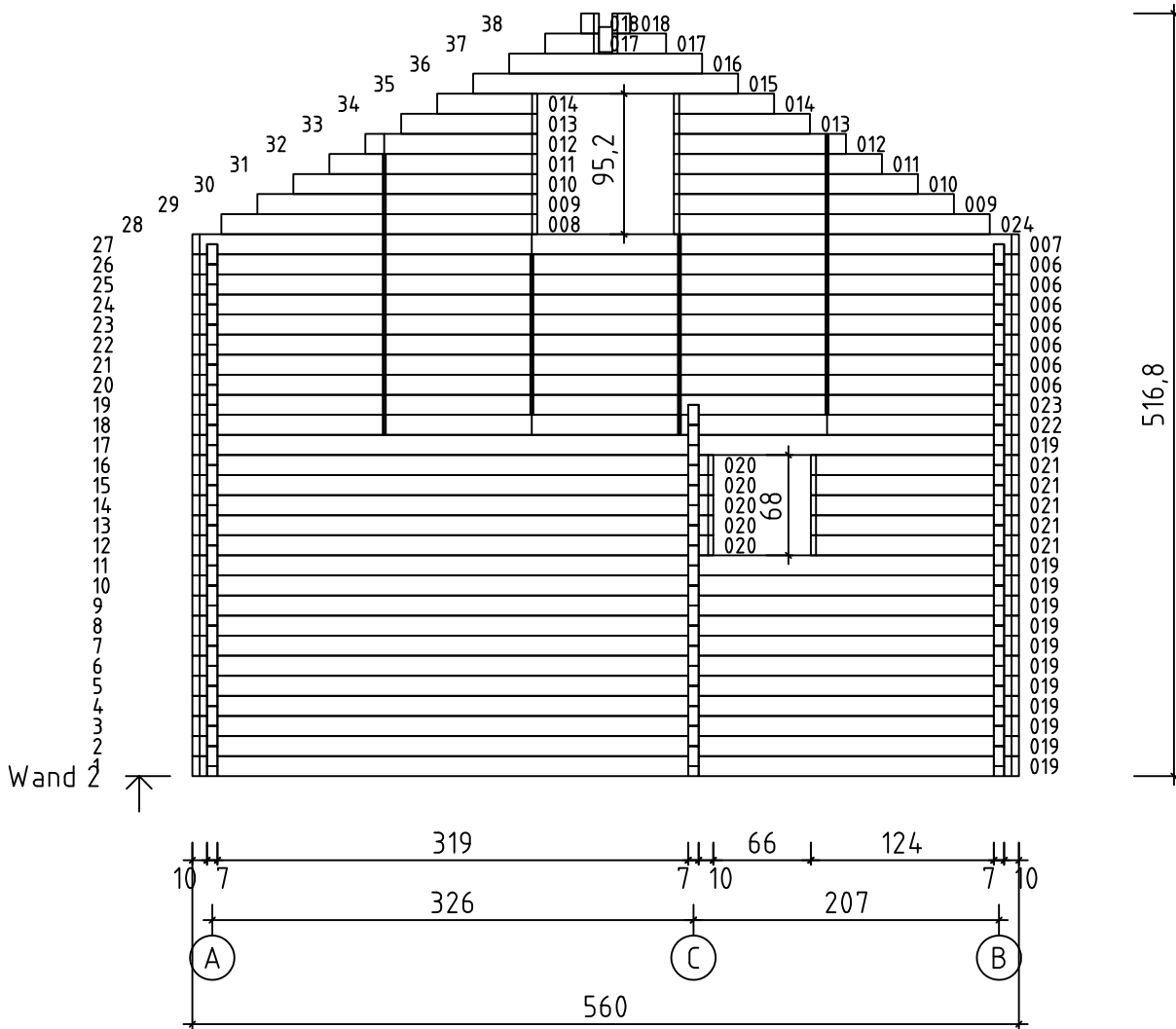

Matterhorn 5.4x7.4

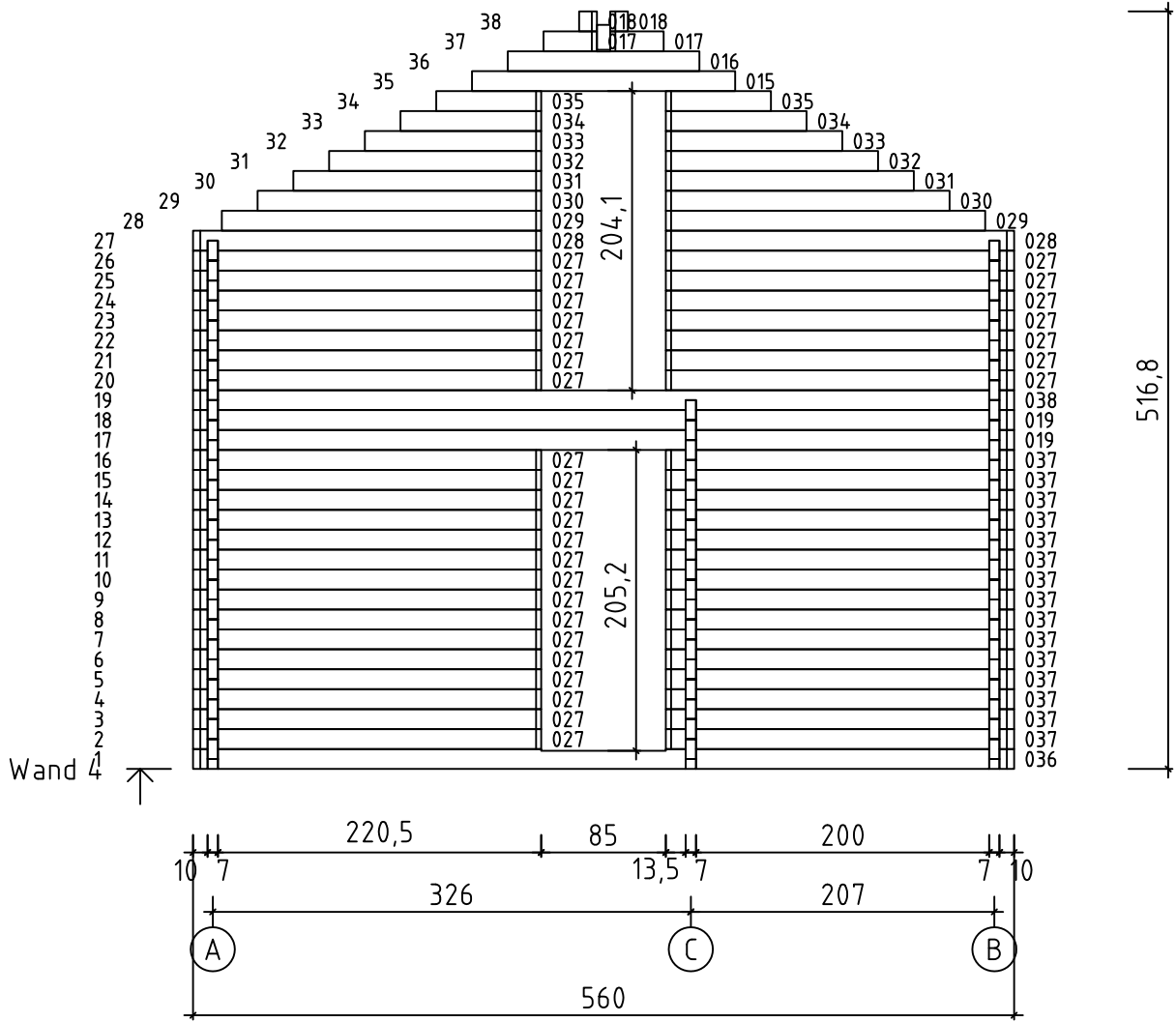

Matterhorn 5.4x7.4

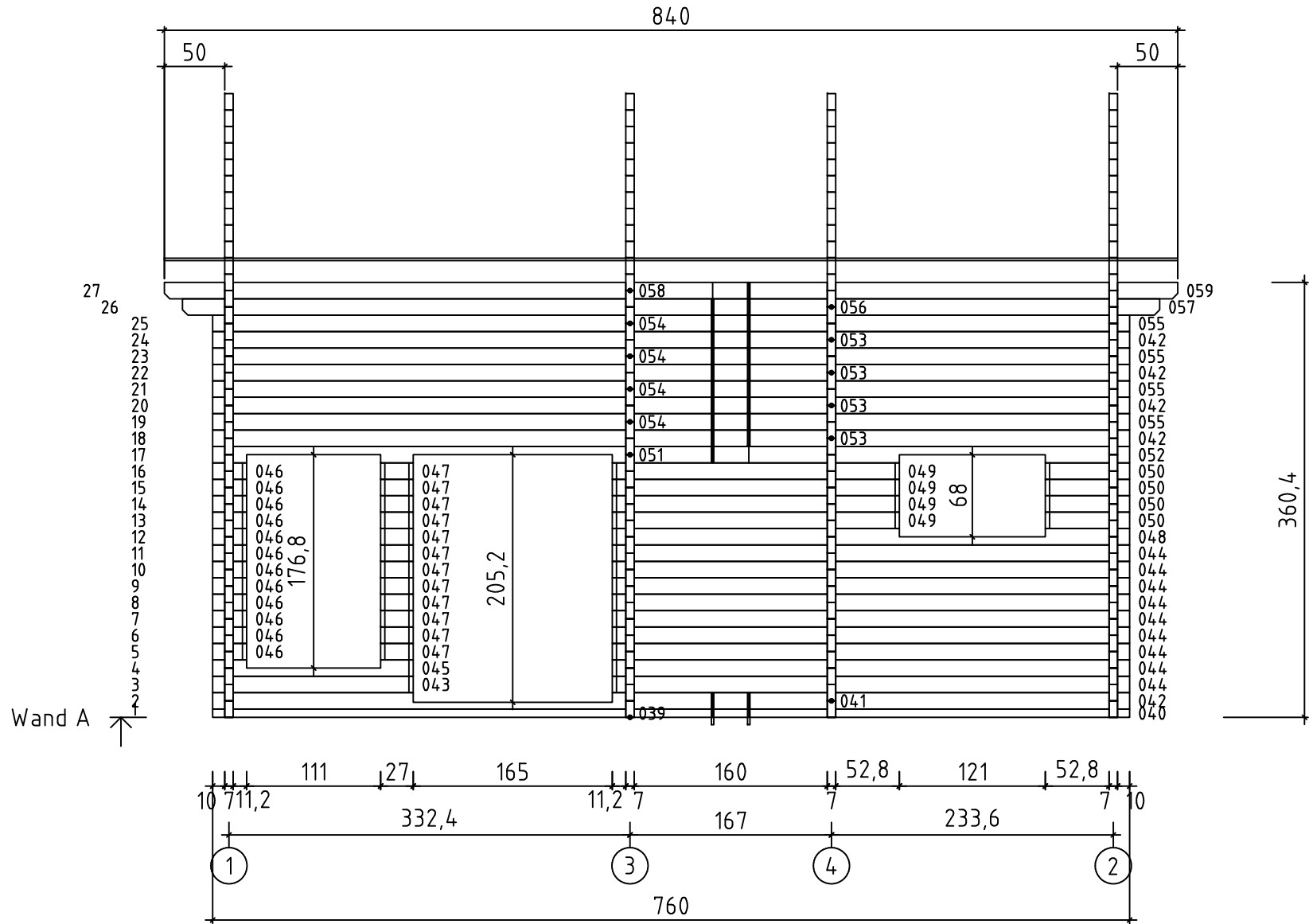



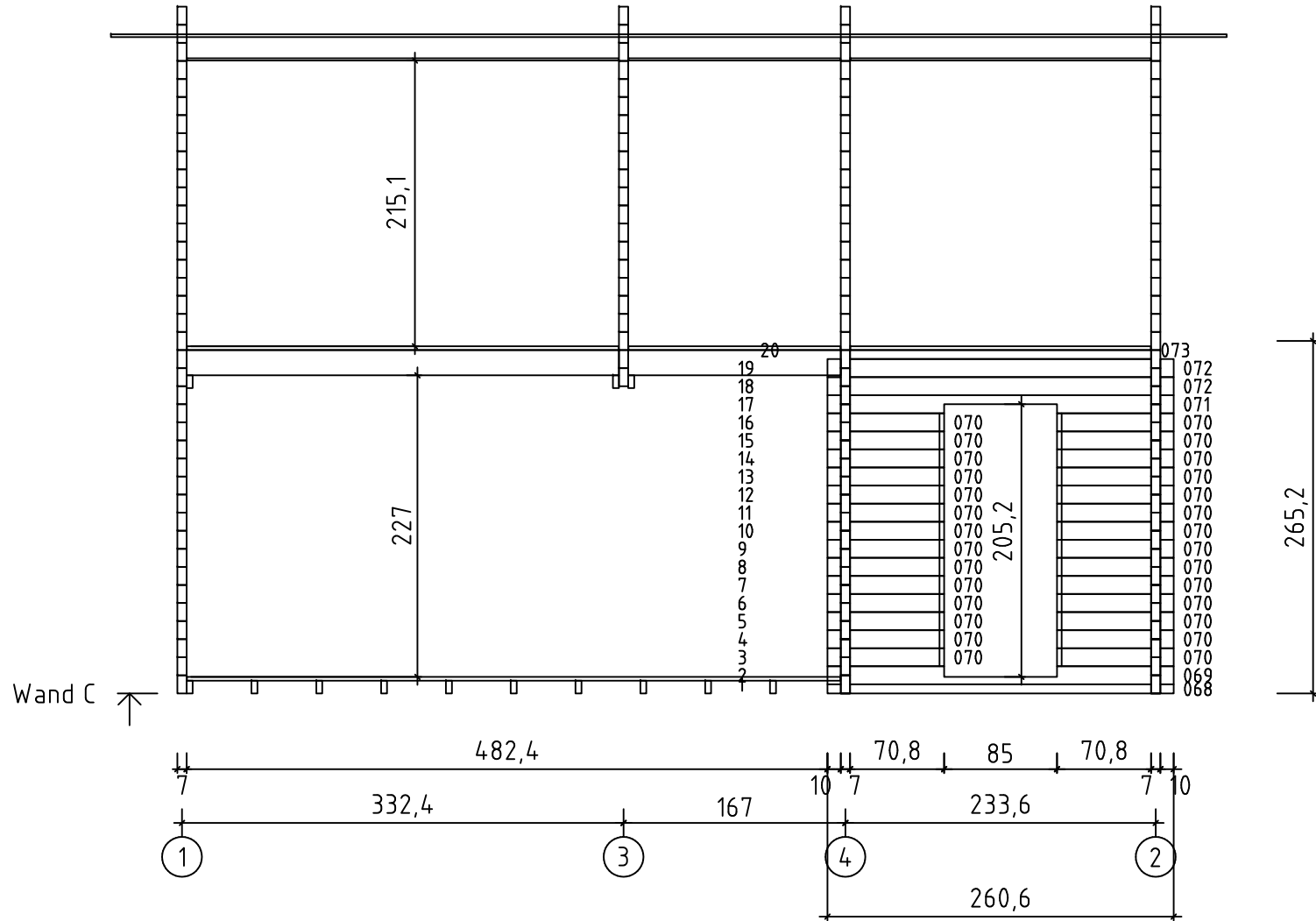



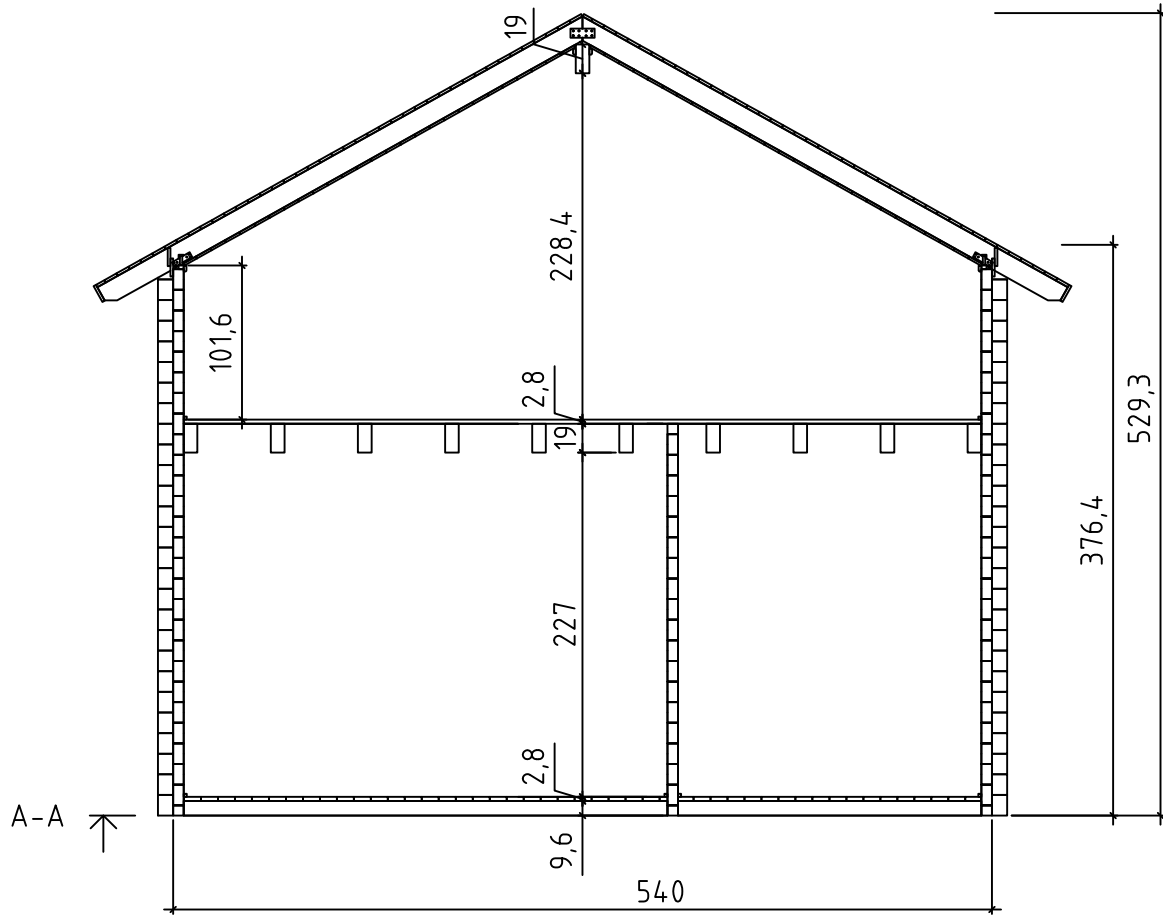

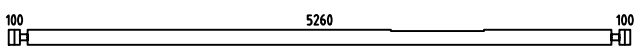
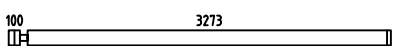
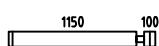
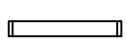
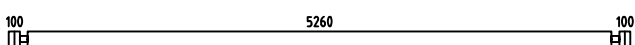
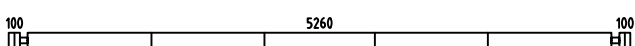
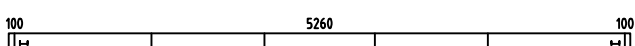
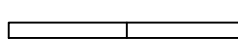
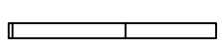
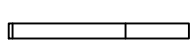
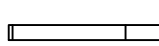
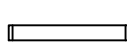
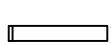

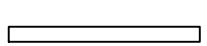
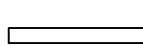

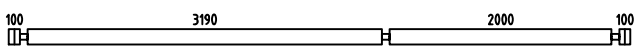
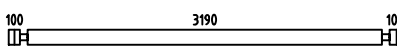
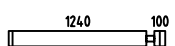



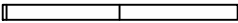

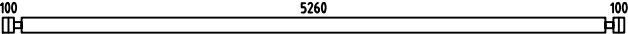
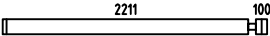
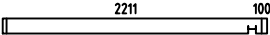
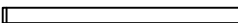

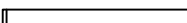
Matterhorn 5.4x7.4

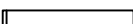

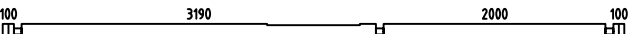
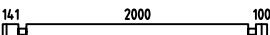
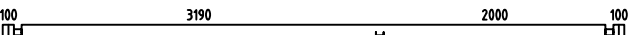
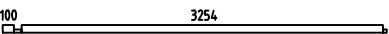

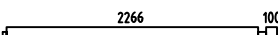
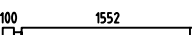

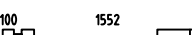



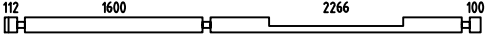
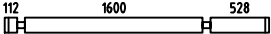

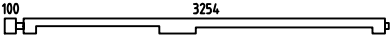
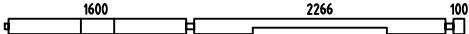
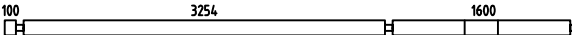
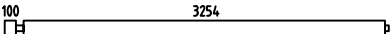
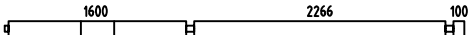

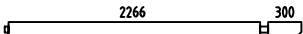
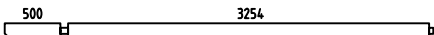
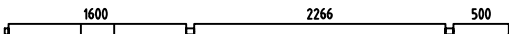
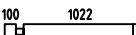
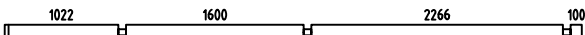
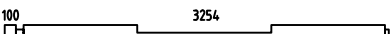
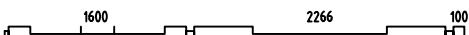
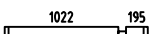

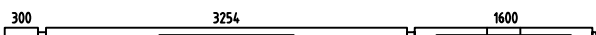
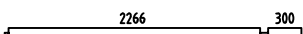
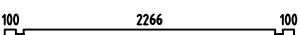



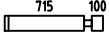
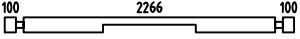
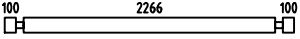

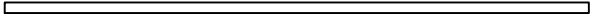
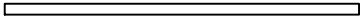

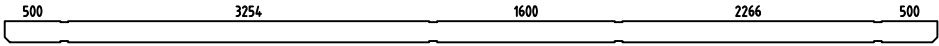
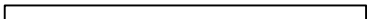
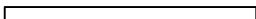
Matterhorn 5.4x7.4

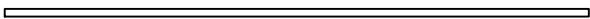
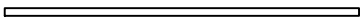
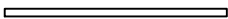
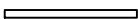









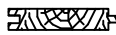
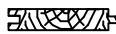



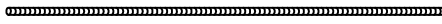
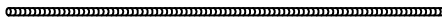
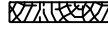
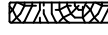
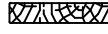
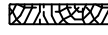
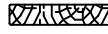







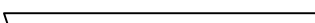
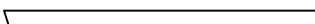
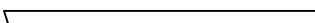















Pos	Matterhorn 5.4x7.4 Stückliste	Q.	P (mm)	L (mm)
001		1	70x136	5600
002		2	70x136	3443
003		28	70x136	1320
004		13	70x136	1013
005		2	70x136	5600
006		16	70x136	5600
007		2	70x136	5600
008		3	70x136	2114
009		4	70x136	1869
010		4	70x136	1624
011		4	70x136	1378
012		4	70x136	1133
013		4	70x136	888
014		4	70x136	643
015		4	70x136	1721
016		4	70x136	1230
017		8	70x136	325
018		8	70x136	79
019		14	70x136	5600
020		5	70x136	3530
021		5	70x136	1410
022		1	70x136	5600
023		1	70x136	5600





Pos	Matterhorn 5.4x7.4 Stückliste	Q.	P (mm)	L (mm)
024		1	70x136	2115
025		34	70x136	370
026		1	70x136	5600
027		43	70x136	2381
028		4	70x136	2381
029		4	70x136	2159
030		4	70x136	1914
031		4	70x136	1668
032		4	70x136	1423
033		4	70x136	1178
034		4	70x136	932
035		4	70x136	687
036		1	70x136	5600
037		15	70x136	2381
038		1	70x136	5600
039		2	70x68	3459
040		2	70x68	4141
041		1	70x136	5129
042		12	70x136	2471
043		1	70x136	1722
044		9	70x136	4288
045		1	70x136	1722
046		12	70x136	282

Pos	Matterhorn 5.4x7.4 Stückliste	Q.	P (mm)	L (mm)
047		12	70x136	330
048		1	70x136	4288
049		4	70x136	2380
050		8	70x136	698
051		1	70x136	3459
052		1	70x136	4141
053		11	70x136	5129
054		11	70x136	3459
055		11	70x136	4141
056		1	70x136	5329
057		1	70x136	2671
058		2	70x136	3859
059		2	70x136	4541
060		9	70x136	1192
061		5	70x136	5198
062		1	70x136	3459
063		1	70x136	4141
064		4	70x136	1287
065		4	70x136	793
066		1	70x136	5329
067		1	70x136	2671
068		1	70x68	2606
069		1	70x136	2606

Pos	Matterhorn 5.4x7.4 Stückliste	Q.	P (mm)	L (mm)
070		28	70x136	885
071		1	70x136	2606
072		2	70x136	2606
073		1	70x68	2266
IAR3	FUNDAMENT 	10	45x96	5260
IAR1	FUNDAMENT 	7	45x96	3190
IAR2	FUNDAMENT 	7	45x96	2000
IAR4	FUNDAMENT 	4	45x96	300
LT1	DACHPFETTEN 	1	90x190	8400
VT1	HALBGESCHOSS BALKEN 	10	90x190	3254
VT2	HALBGESCHOSS BALKEN 	10	90x190	2266
VT3	HALBGESCHOSS BALKEN 	7	90x190	1600
VT7	HALBGESCHOSS BALKEN 	3	44x70	5260
VT4	HALBGESCHOSS BALKEN 	2	44x70	3190
VT5	HALBGESCHOSS BALKEN 	3	44x70	2000
VT6	HALBGESCHOSS BALKEN 	1	44x70	1190
SR1	DACHSPARREN 	40	70x140	3659
STP-1	DECKENBRETTER 	54	111x14	3250
STP-2	DECKENBRETTER 	54	111x14	2262
STP-3	DECKENBRETTER 	54	111x14	1596
HLL-1	FUSSBODENBRETTER 	41	137x28	5256
HLL-2	FUSSBODENBRETTER 	39	137x28	4920
HLL-3	FUSSBODENBRETTER 	12	137x28	3260

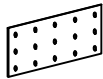
Pos	Matterhorn 5.4x7.4 Stückliste	Q.	P (mm)	L (mm)
HLL-4	FUSSBODENBRETTER 	39	137x28	2262
RB-1	DACHBRETTER 	82	90x18	4439
RB-2	DACHBRETTER 	82	90x18	3961
LL-1	DECKENLEISTE 		15x40	64
FL-1	FUSSBODENLEISTE 		15x40	82
DPL-1	DACHPAPPENLEISTE 	4	18x58	3719
M12-1	GEWINDESTANGE M12 	8		1705
M12-2	GEWINDESTANGE M12 	8		2000
TB-1	TRAUFBRETT 	12	18x120	440
TB-2	TRAUFBRETT 	24	18x120	461
TB-3	TRAUFBRETT 	16	18x120	479
TB-4	TRAUFBRETT 	2	18x120	3929
TB-5	TRAUFBRETT 	2	18x120	4471
TBE6-1	FIXIRUNGSLEISTE FÜR FENSTER 	8	28x34	514
TBE6-2	FIXIRUNGSLEISTE FÜR FENSTER 	4	28x34	650
TBE6-3	FIXIRUNGSLEISTE FÜR FENSTER 	4	28x34	916
TBE6-4	FIXIRUNGSLEISTE FÜR FENSTER 	2	28x34	1593
TBE6-5	FIXIRUNGSLEISTE FÜR FENSTER 	2	28x34	1729
TBE6-1	FIXIRUNGSLEISTE FÜR TÜR 	4	28x34	1864
TBE6-2	FIXIRUNGSLEISTE FÜR TÜR 	8	28x34	2000
GL3-1	GIEBELLEISTE 	4	18x90	3719
GL-1	GIEBELLEISTE 	4	18x120	3669
GL-2	GIEBELLEISTE 	4	18x120	3719

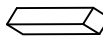
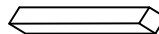
Pos	Matterhorn 5.4x7.4 Stückliste		Q.	P (mm)	L (mm)
KL4	VERLÄNGERUNGSMUTTER FÜR GEWINDESTANGE		8		
KL1	EINSHLAGMUTTER FÜR GEWINDESTANGE		8		
KL2	MUTTER FÜR GEWINDESTANGE		8		
KL3	UNTERLEGSCHIBE FÜR GEWINDESTANGE		8		
HS12	SCHRAUBEN FÜR DECKBLATT		4	3.5x35	
HS25	SCHRAUBEN FÜR FUSSBODENBRETTER		1225	3.5x50	
HS84	SCHRAUBEN FÜR FIXIRUNGSLEISTE		128	3.5x50	
HS16	SCHRAUBEN FÜR GIEBELLEISTE		112	3.5x50	
NFD	SCHRAUBEN FÜR DACHPAPPENLEISTE		36	4x40	
HS73	SCHRAUBE FÜR ANSCHLUSSPLATTE		160	4x40	
HS32	SCHRAUBEN FÜR TRAFBRETTER		142	4x40	
HS86	SCHRAUBEN FÜR DACHSPARREN SCHIEBEREGLER		320	4x40	
HS89	SCHRAUBEN FÜR HALBGESCHOSS BALKEN		71	5x100	
HS42	SCHRAUBEN FÜR GIEBEL		8	5x120	
HS63	SCHRAUBEN FÜR HALBGESCHOSS BALKEN		54	6x150	
HS44	SCHRAUBEN ZUR BEFESTIGUNG DACHSPARREN		40	6x180	
HS66	SCHRAUBEN FÜR DACHPFETTEN		8	8x220	
MS	SCHRAUBEN FÜR TÜRSCHWELLE		13	4.5x65	
SH70	SCHLAGHOLZ		2		
NFC	ZN NÄGEL FÜR DECKENLEISTEN		130	1.4x40	
NFF	ZN NÄGEL FÜR FUSSBODENLEISTEN		165	1.4x40	
NF2	ZN NÄGEL FÜR DACHBRETTER		1722	2.1x50	
NF2	ZN NÄGEL FÜR DECKENBRETTER		896	2.1x50	

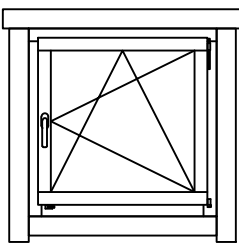
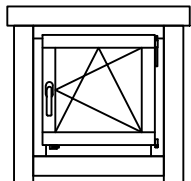
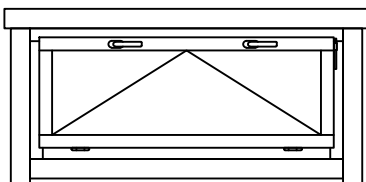
Pos	Matterhorn 5.4x7.4 Stückliste	Q.	P (mm)	L (mm)
KR2	ANSCHLUSSPLATTE 	20		
ORZ	MONTAGE-SET FÜR TÜREN UND FENSTER	1		
GS	DECKBLATT 	2		
SP2	HOLZDÜBEL 	6		
SP1	HOLZDÜBEL 	70		
RLGR	SCHIEBEREGLER FÜR DACHSPARREN 	40		
TRL	TREPPE	1		
	FENSTER  916x916 2+ A.0P	2		
	FENSTER  650x650 2+ A.0P.c	1		
	FENSTER  1200x650 2+ A.0Ü.b	5		

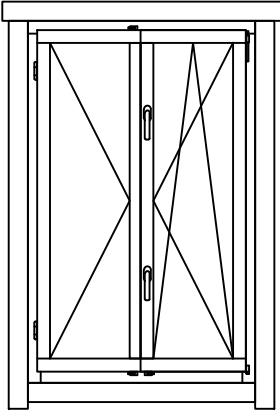
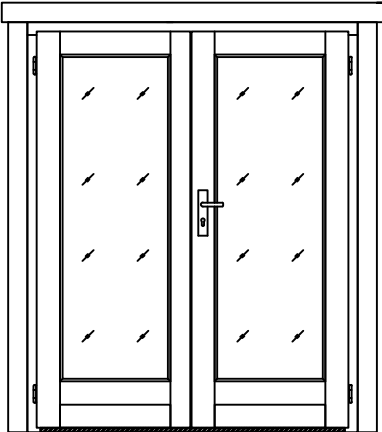
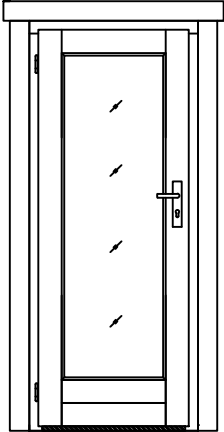
Pos	Matterhorn 5.4x7.4 Stückliste	Q.	P (mm)	L (mm)
FENSTER	<div style="text-align: right;">1100x1729 2+ TA.0P.b</div> 	2		
TÜR	<div style="text-align: right;">1580x2000 2+ TU.10P.b</div> 	1		
TÜR	<div style="text-align: right;">827x2000 2+ U.10V.b</div> 	1		

