

Grossglockner 70

Art.No. 7011141

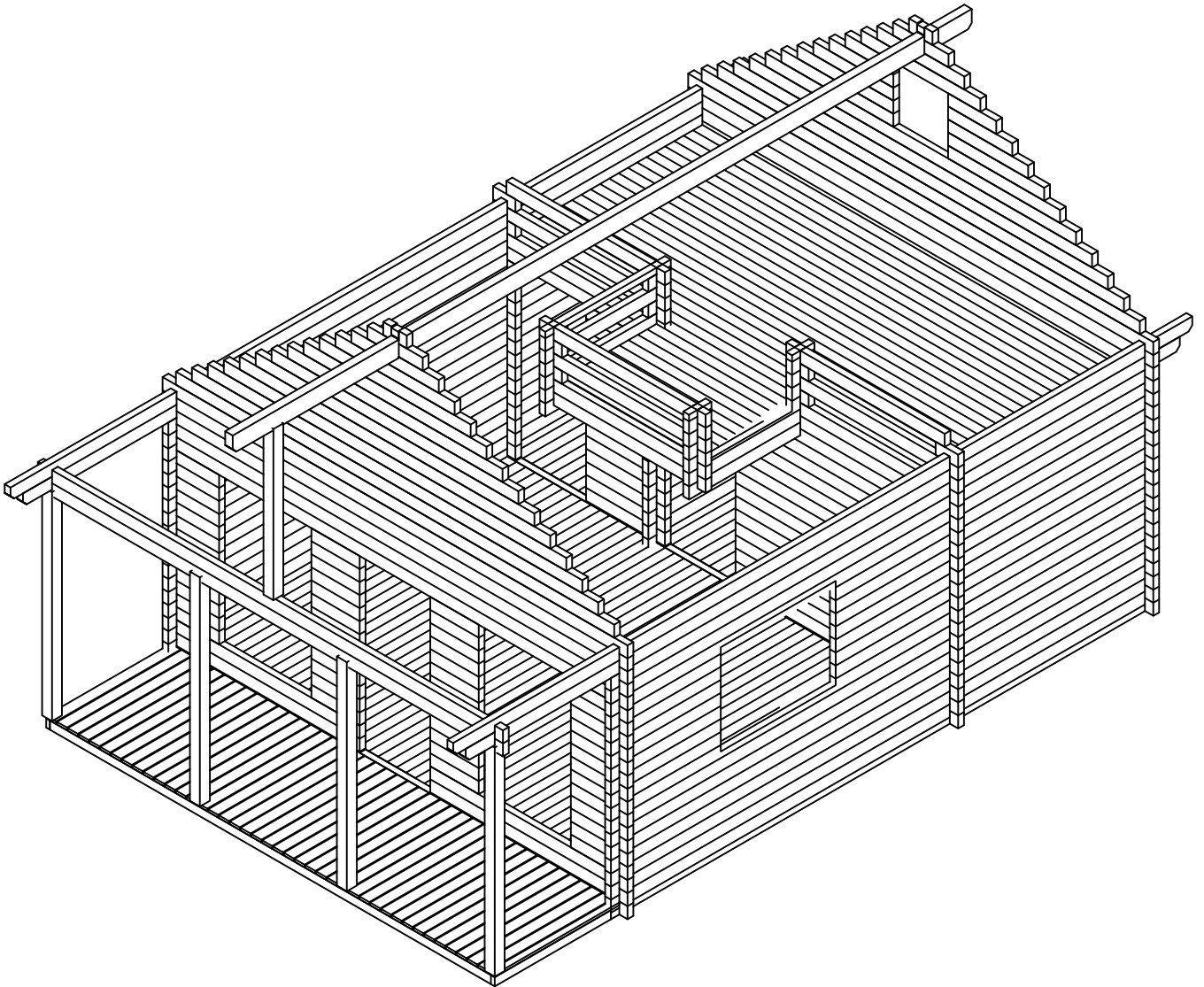

Grossglockner 70, Art.No.7011141
GROUNDPLAN - GRUNDPLAN - PLAN DE MASSE

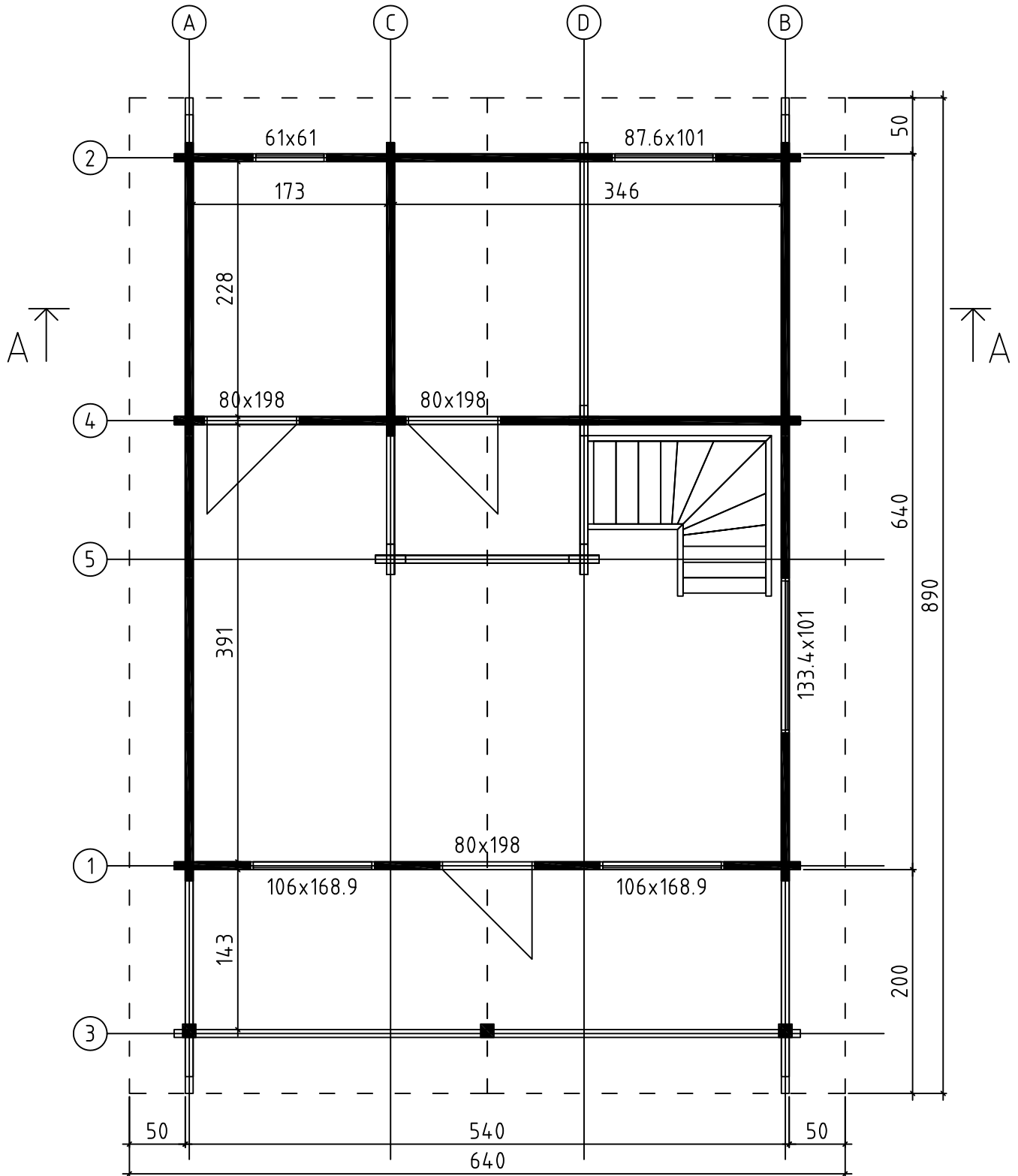

Grossglockner 70, Art.No.7011141
GROUNDPLAN - GRUNDPLAN - PLAN DE MASSE

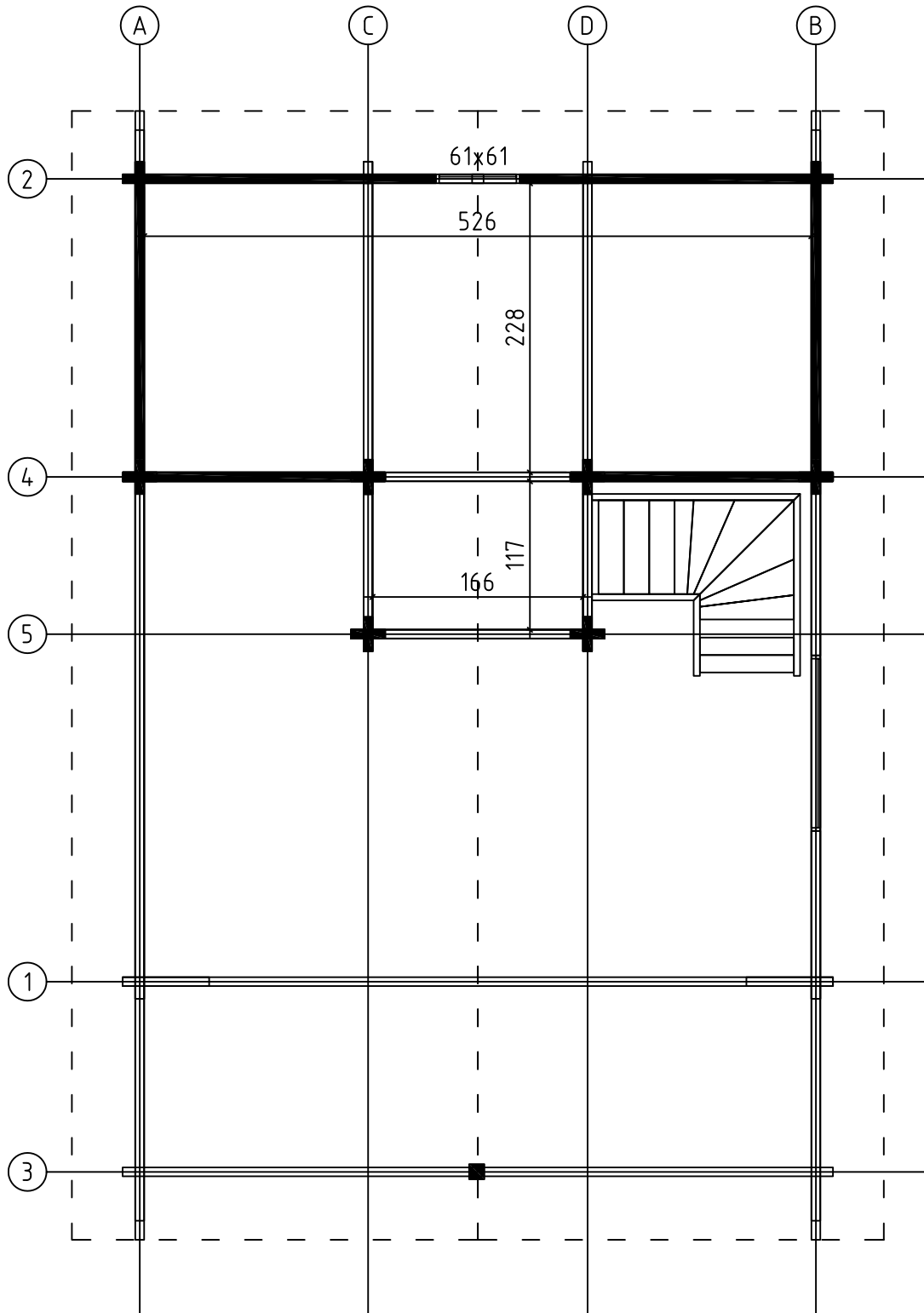

Grossglockner 70, Art.No.7011141
 FOUNDATION - FUNDAMENT - FONDATION

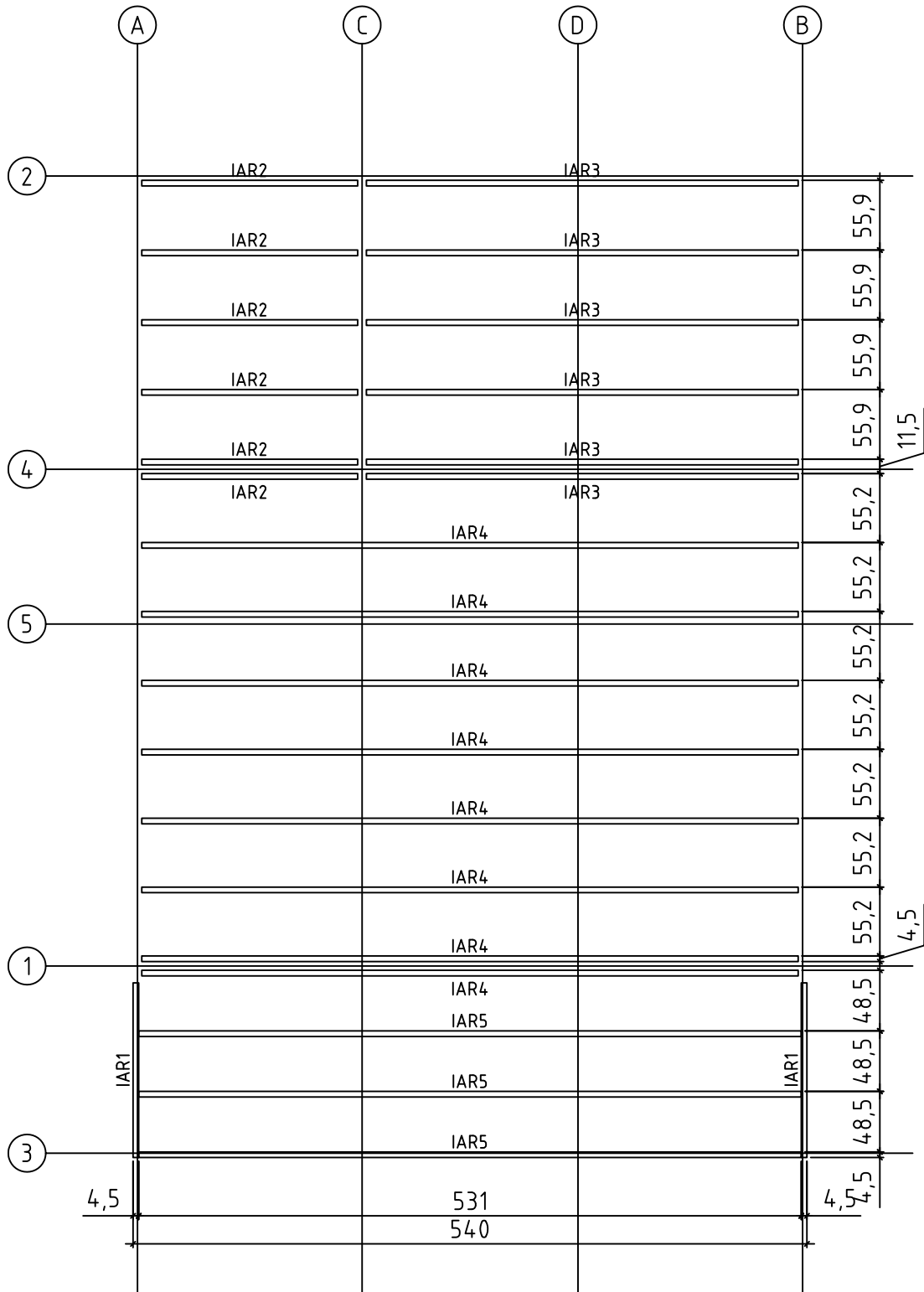

Grossglockner 70, Art.No.7011141
RAFTERS PLAN - DACHSPARREN - PLAN DE CHEVRON

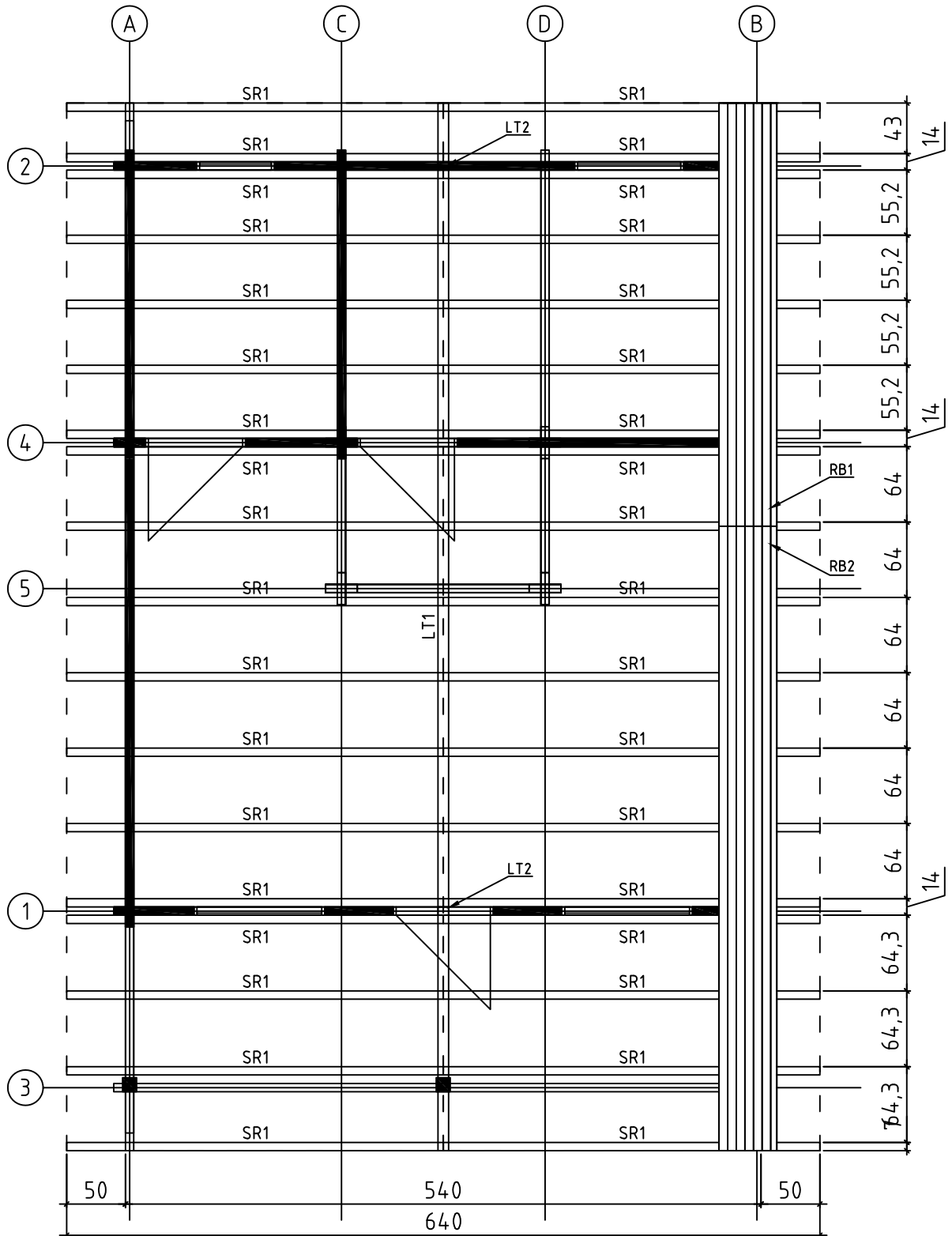

Grossglockner 70, Art.No.7011141
MEZZANINE FLOOR JOISTS -HALBGESCHOSS BALKEN - SOLIVES DE PLANCHER MEZZANINE

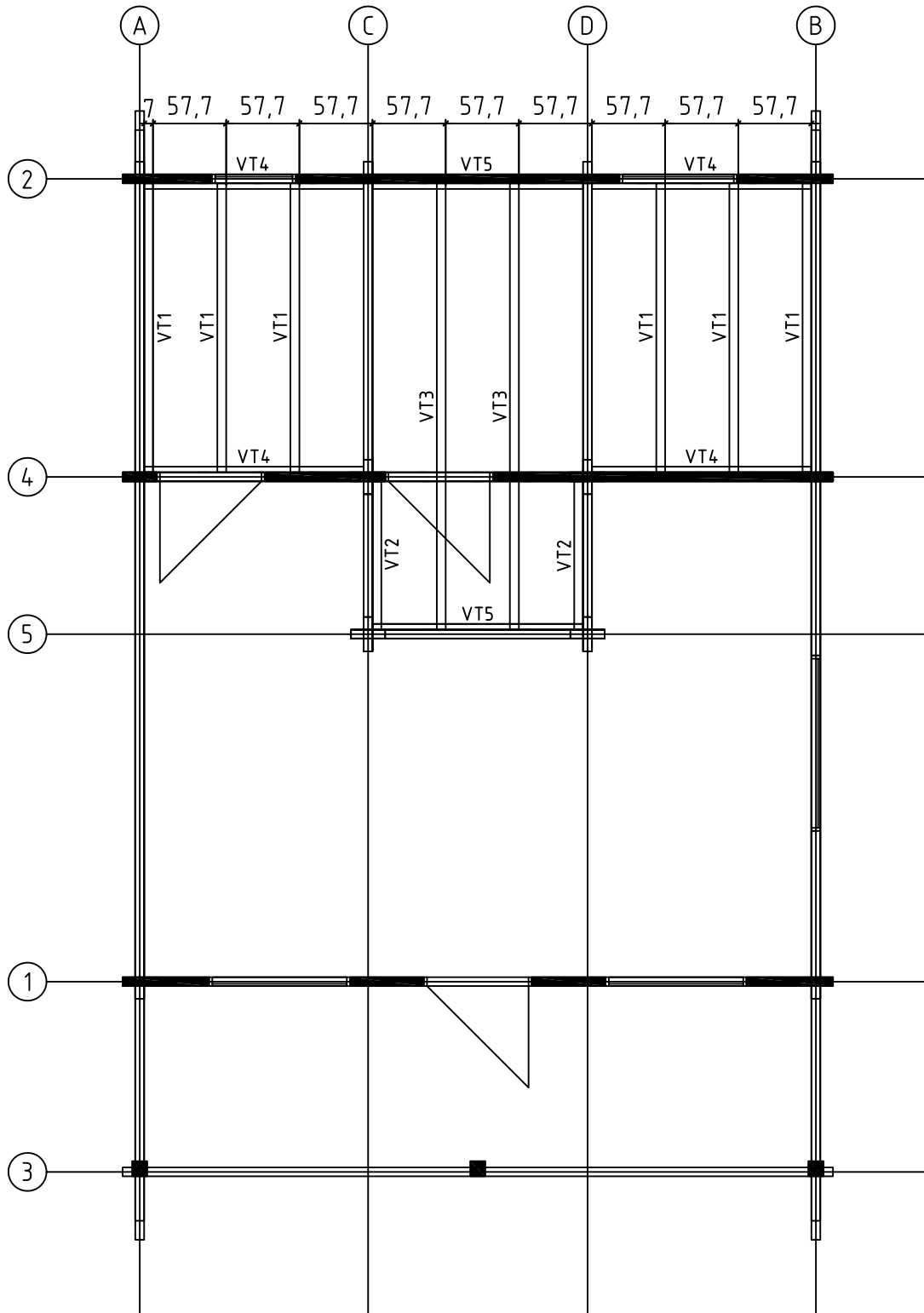

Grossglockner 70, Art.No.7011141
FLOOR BOARDS - FUSSBODENBRETTER - PLAN POSE PLANCHER

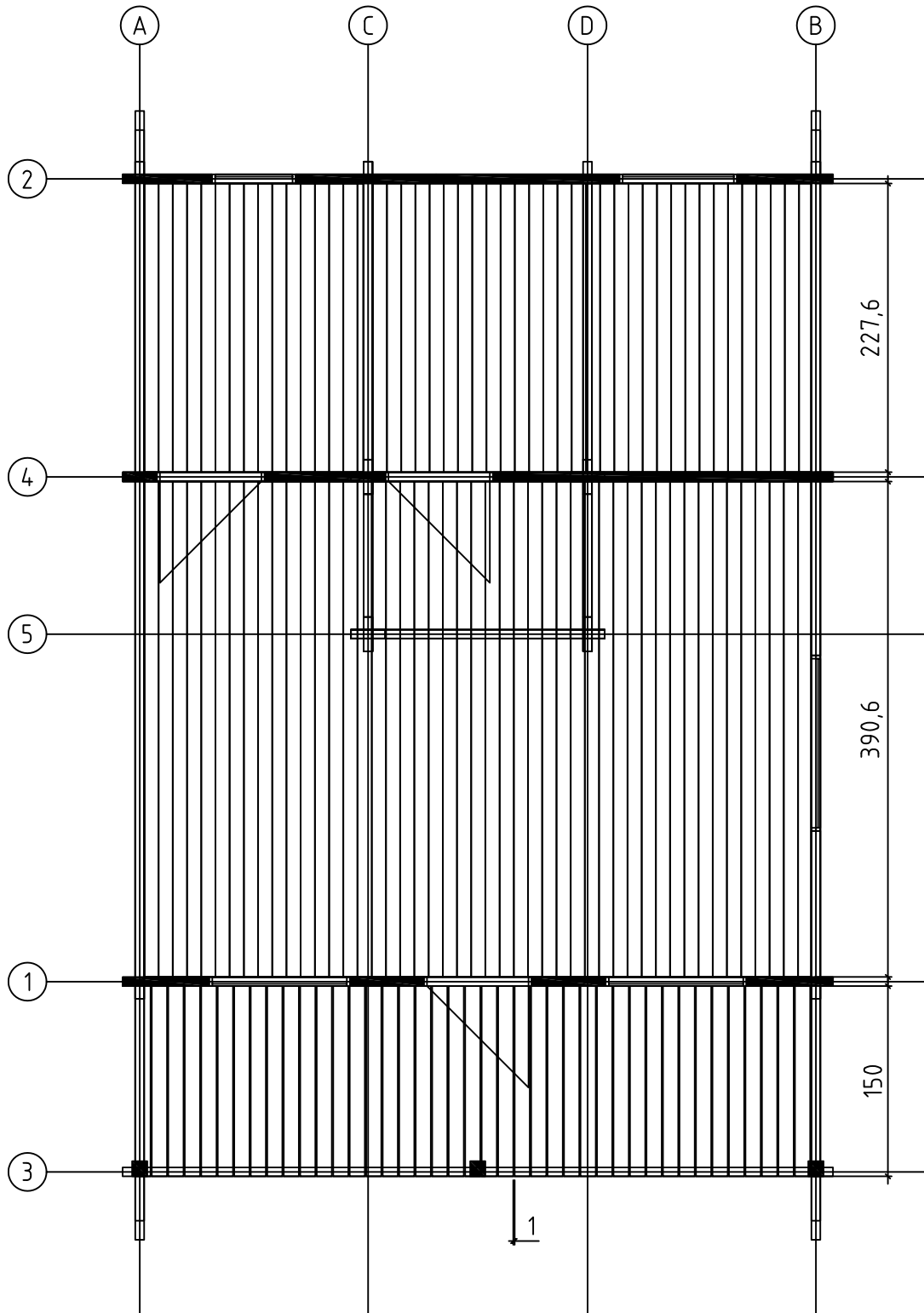

Grossglockner 70, Art.No.7011141
FLOOR BOARDS - FUSSBODENBRETTER - PLAN POSE PLANCHER

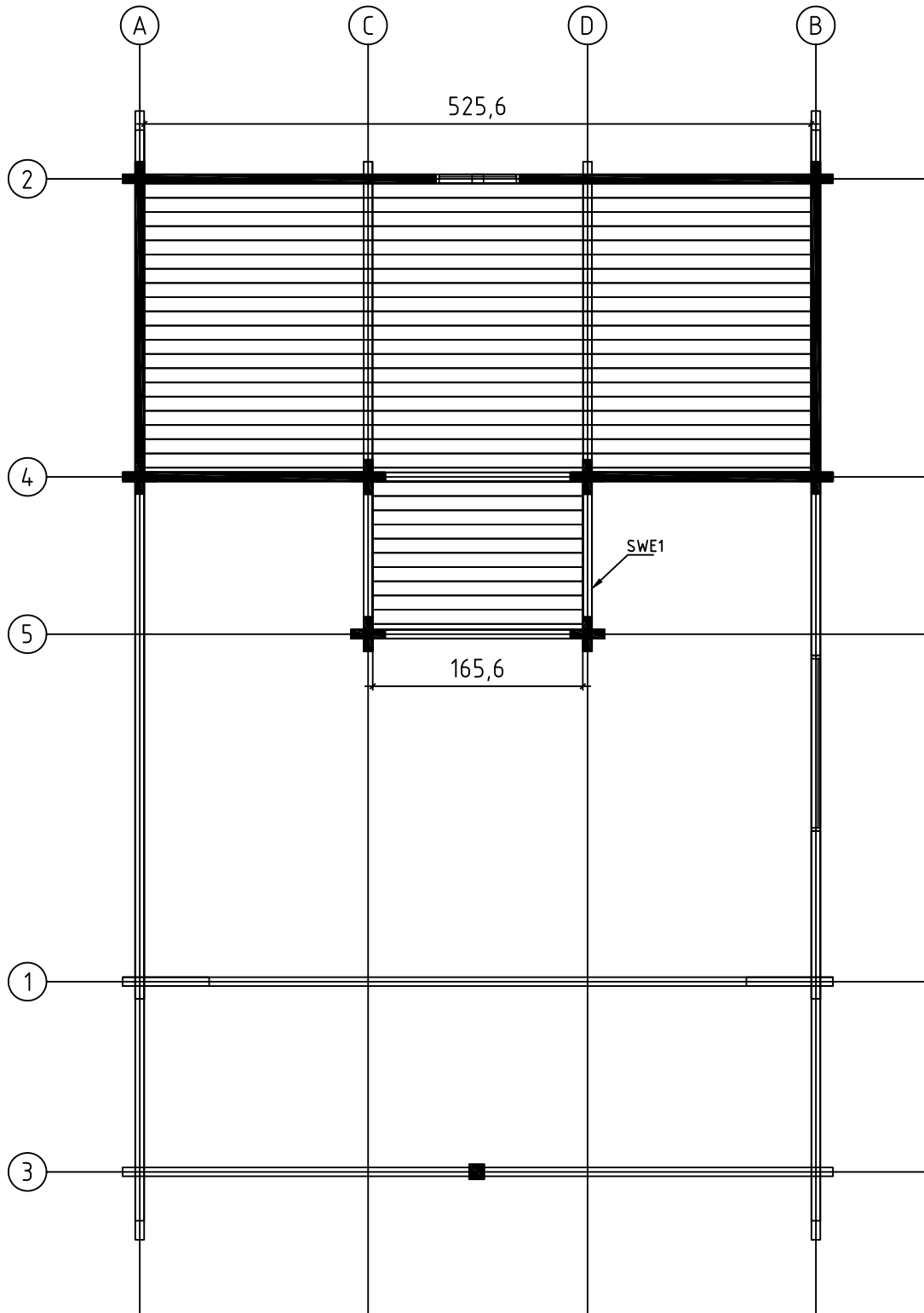

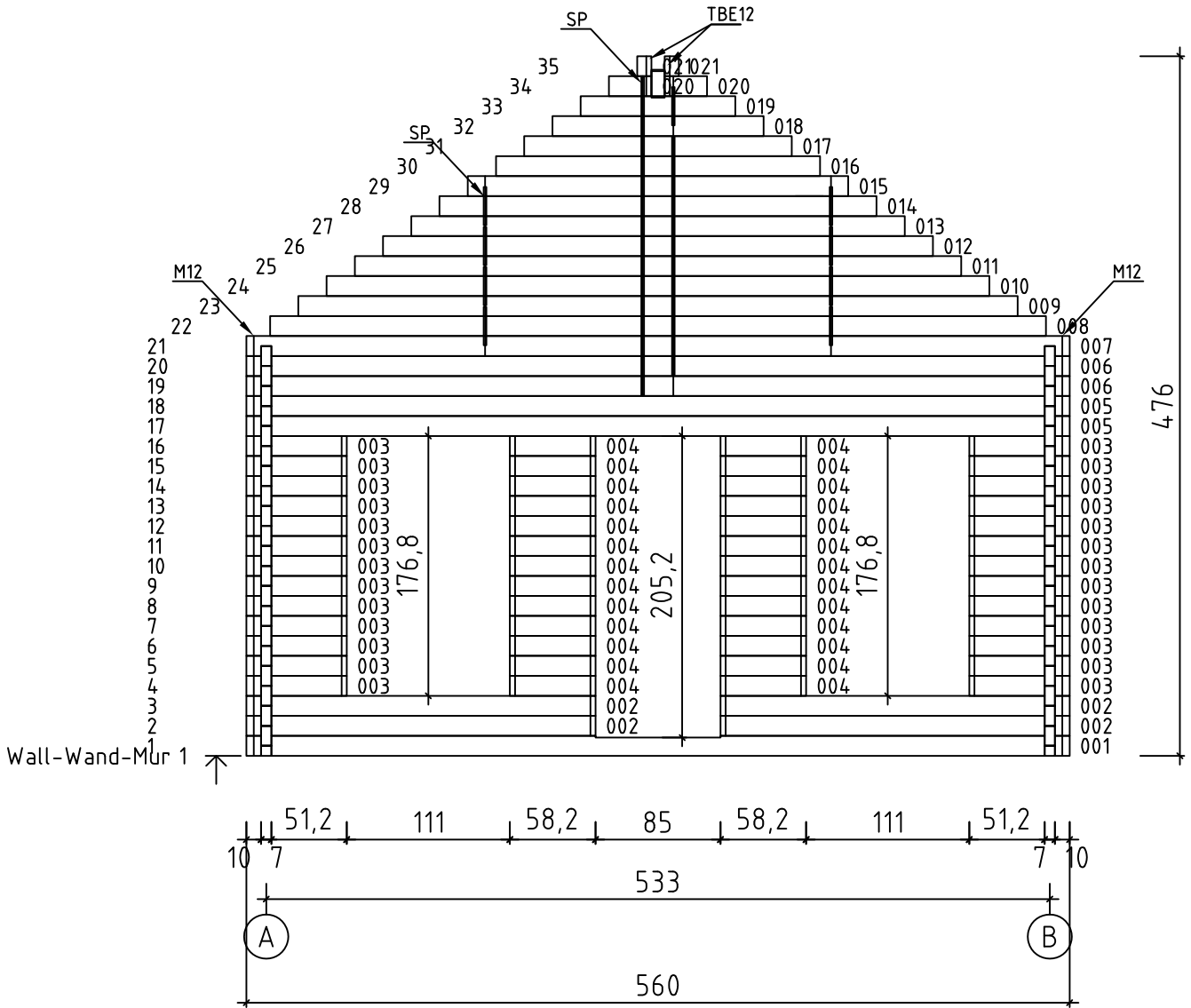

Grossglockner 70, Art.No.7011141

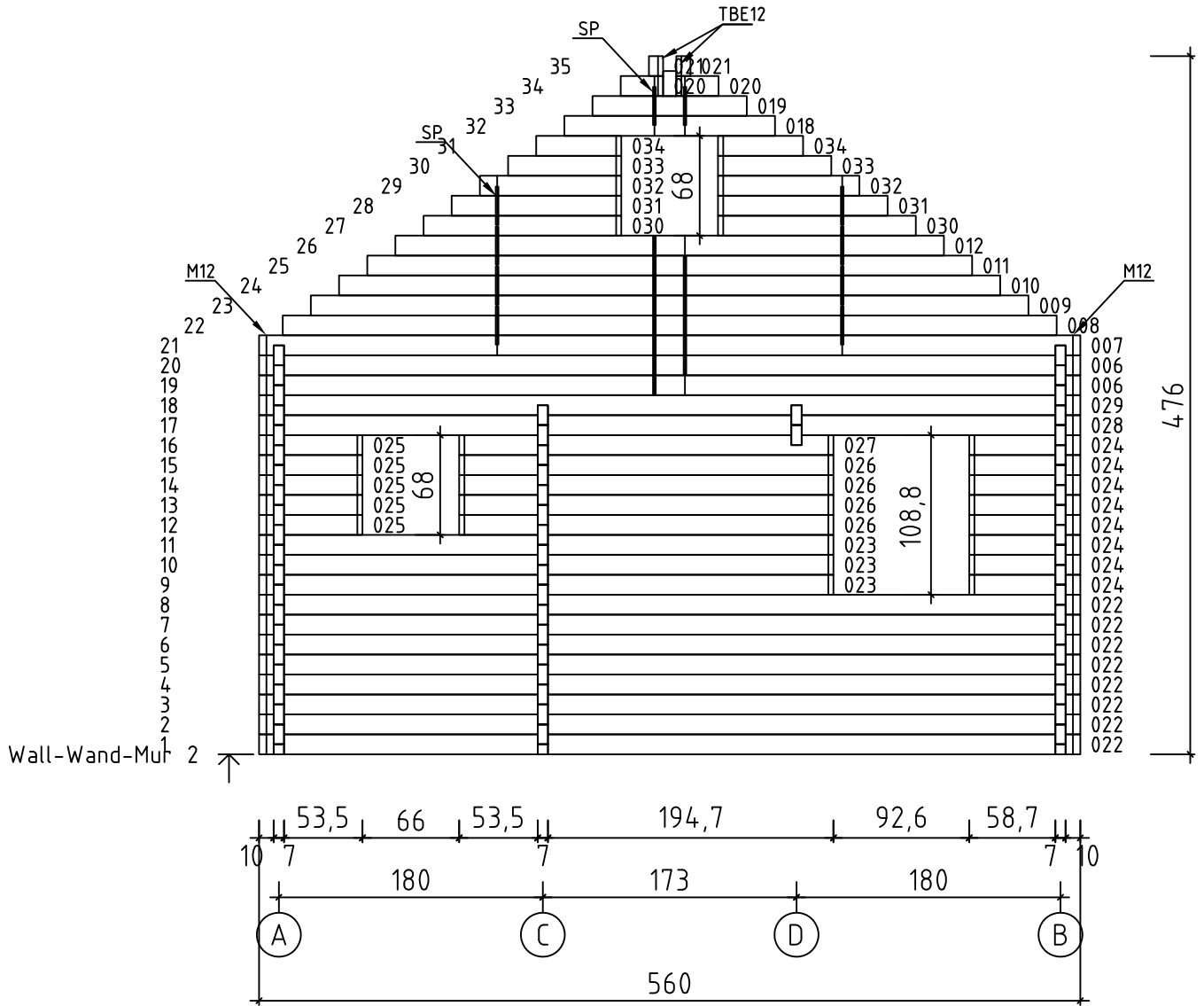

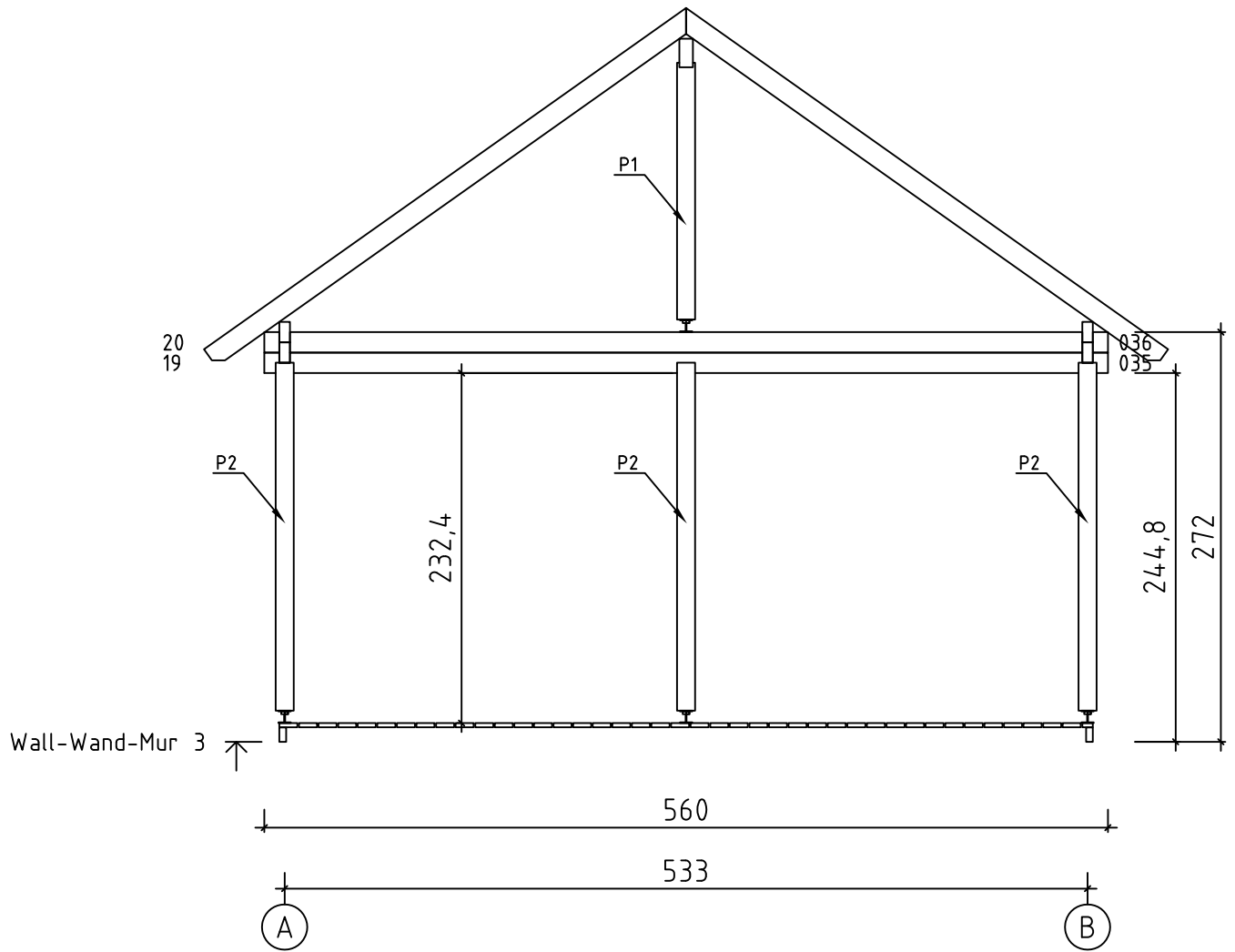

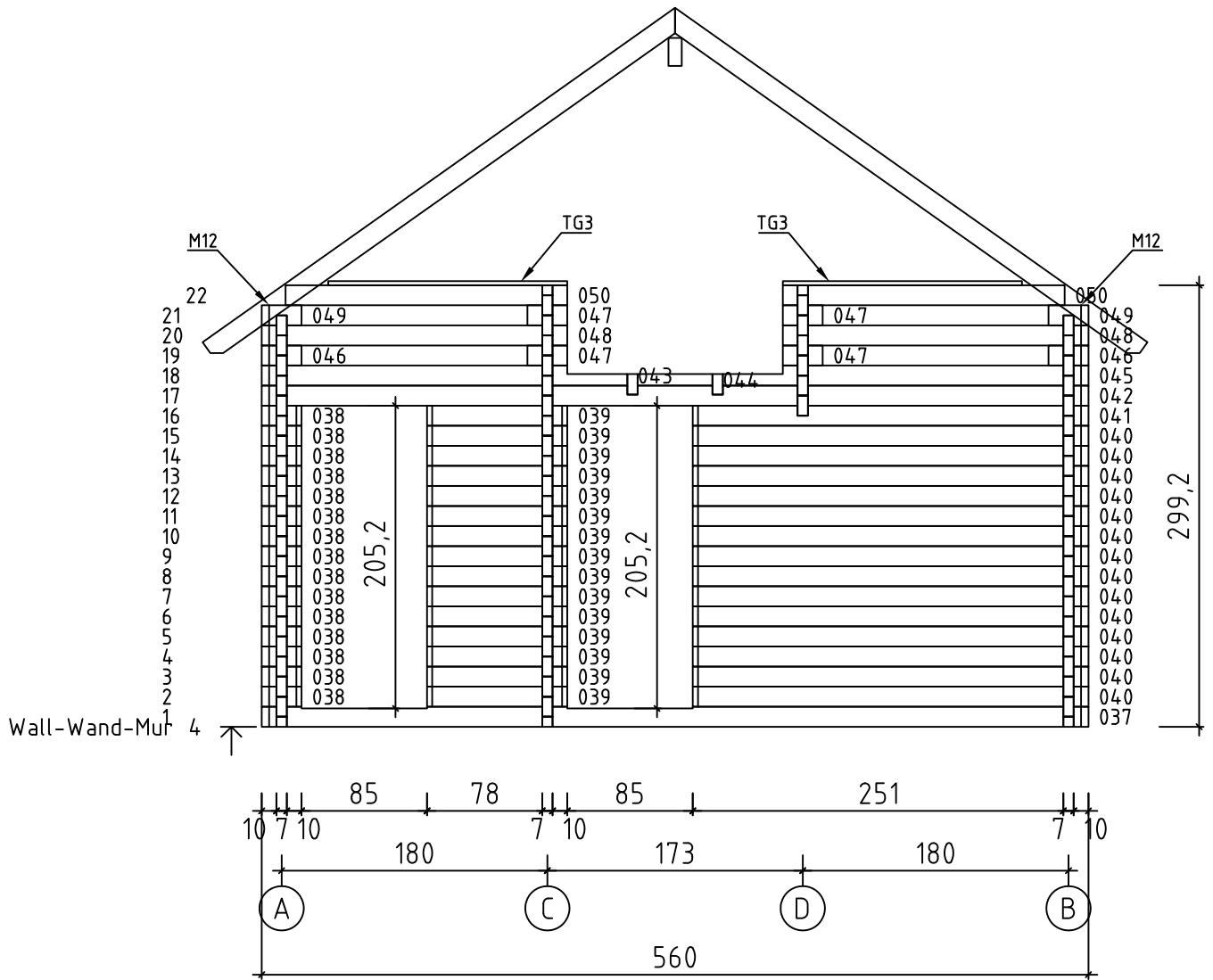

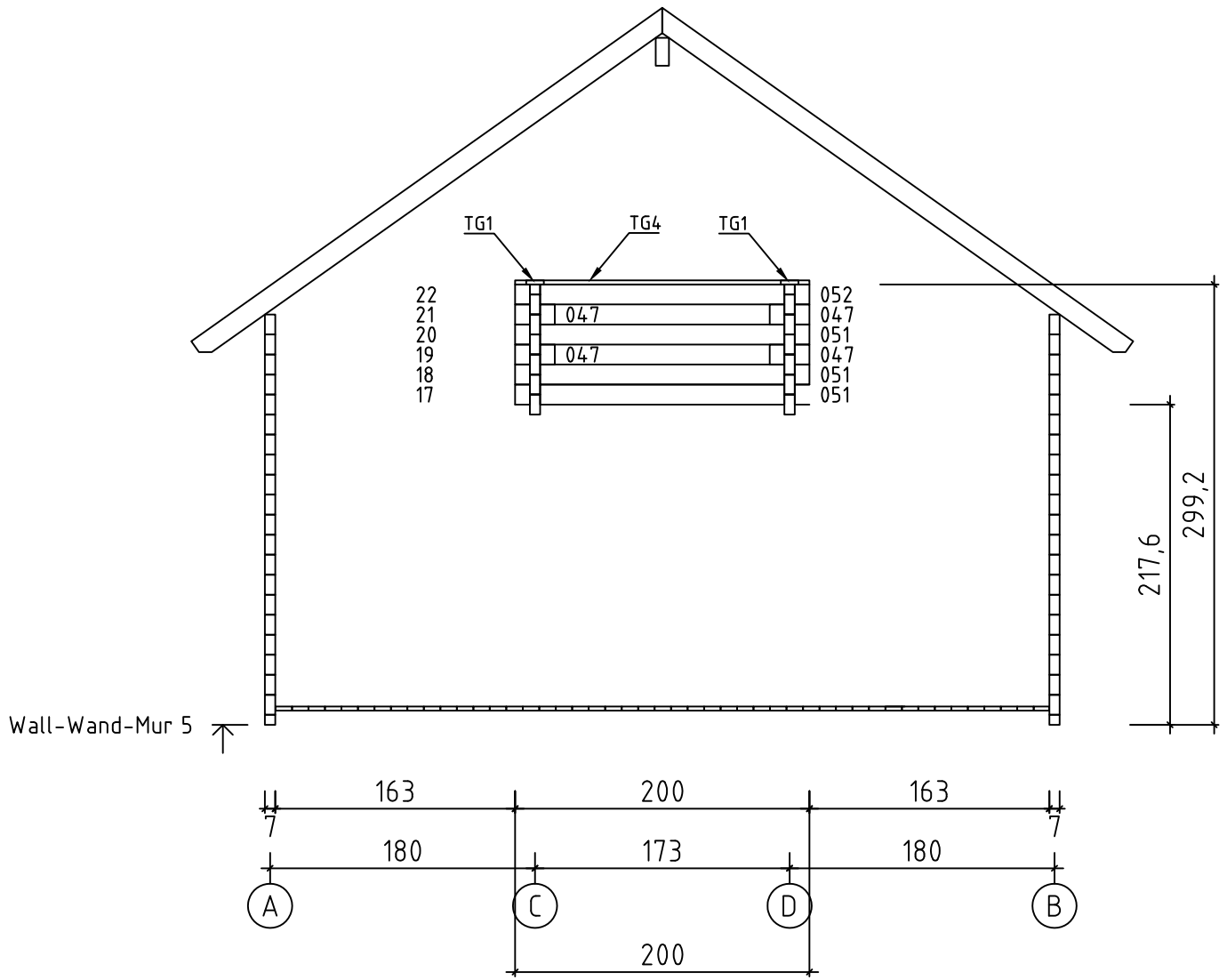

Grossglockner 70, Art.No.7011141

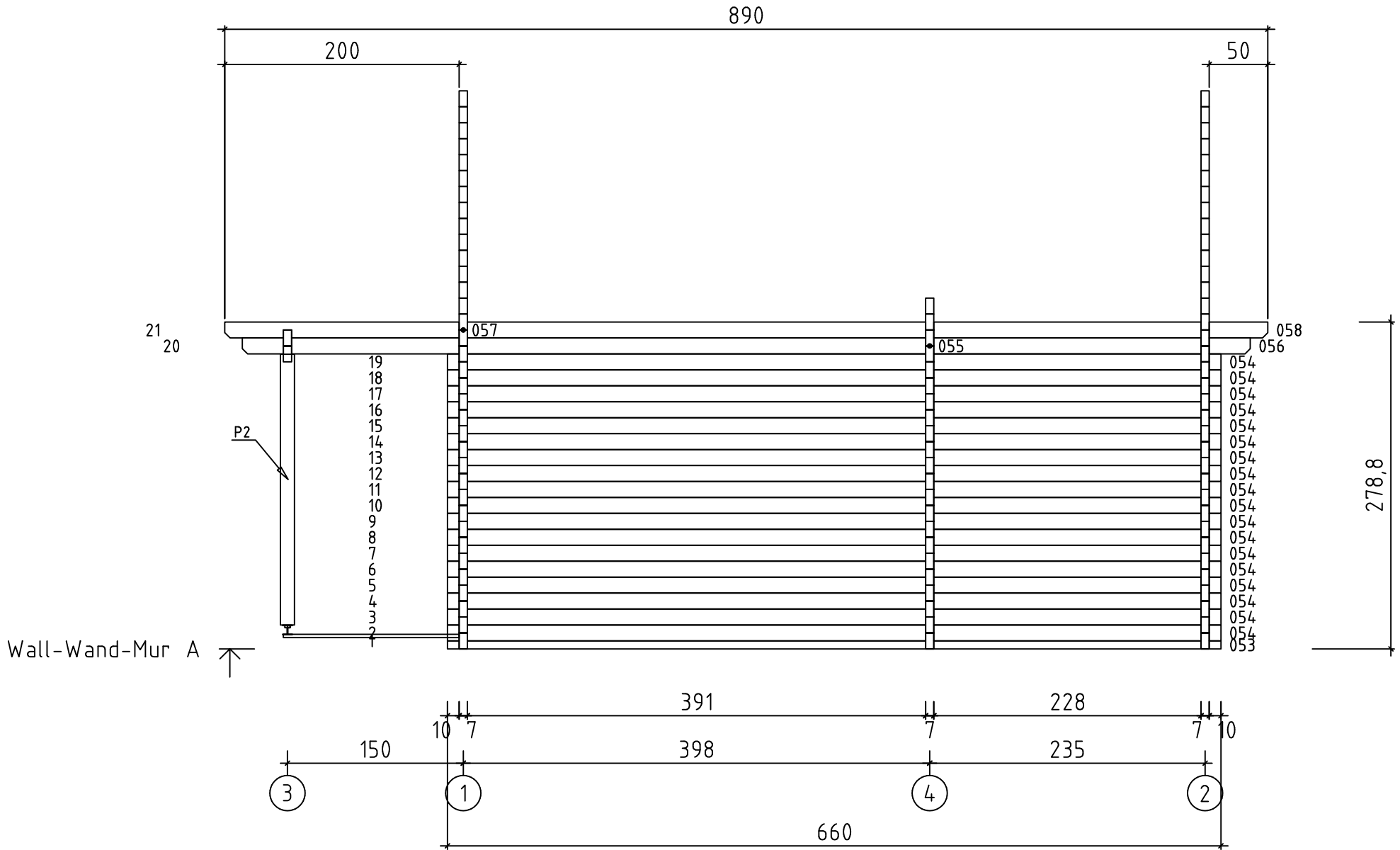



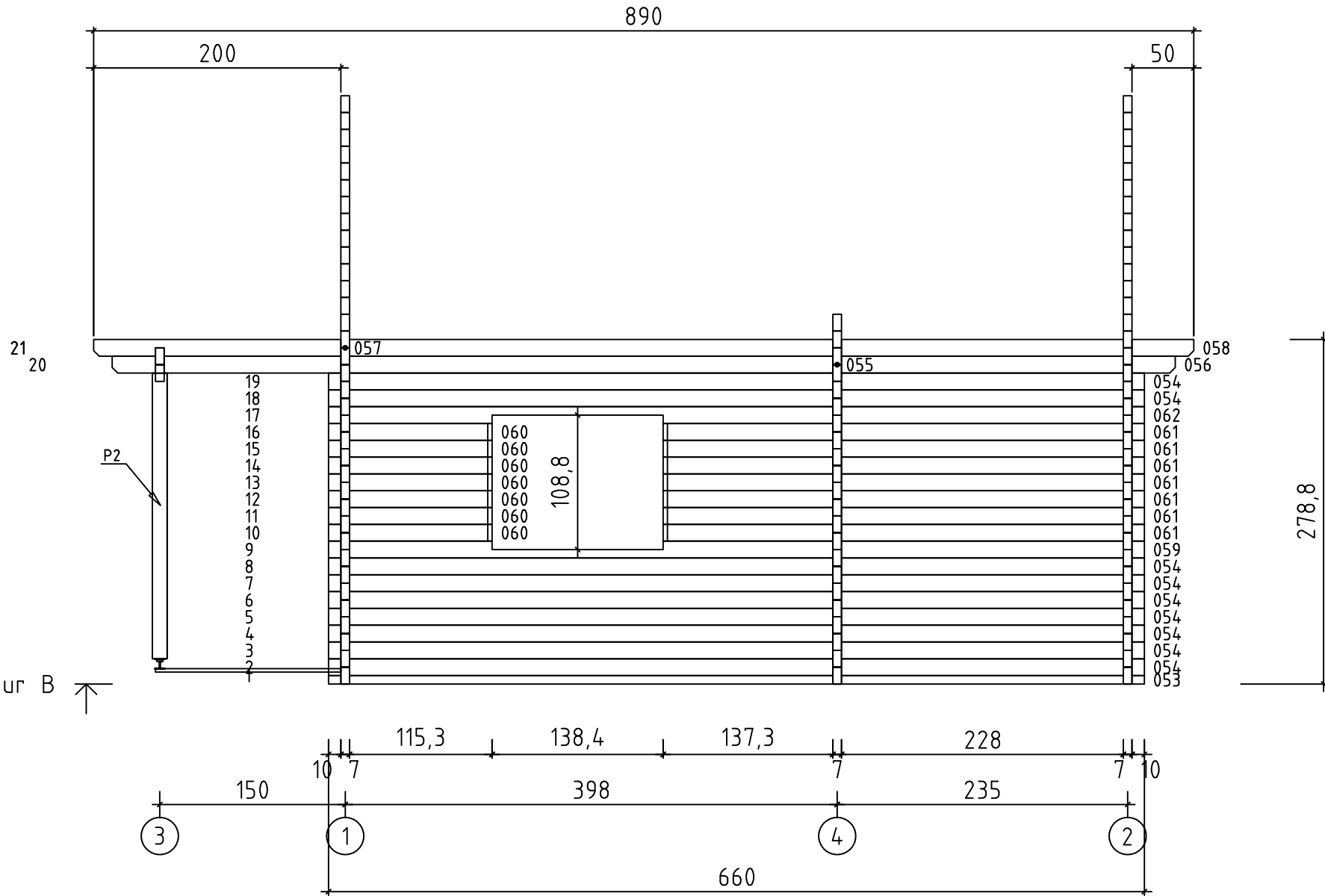

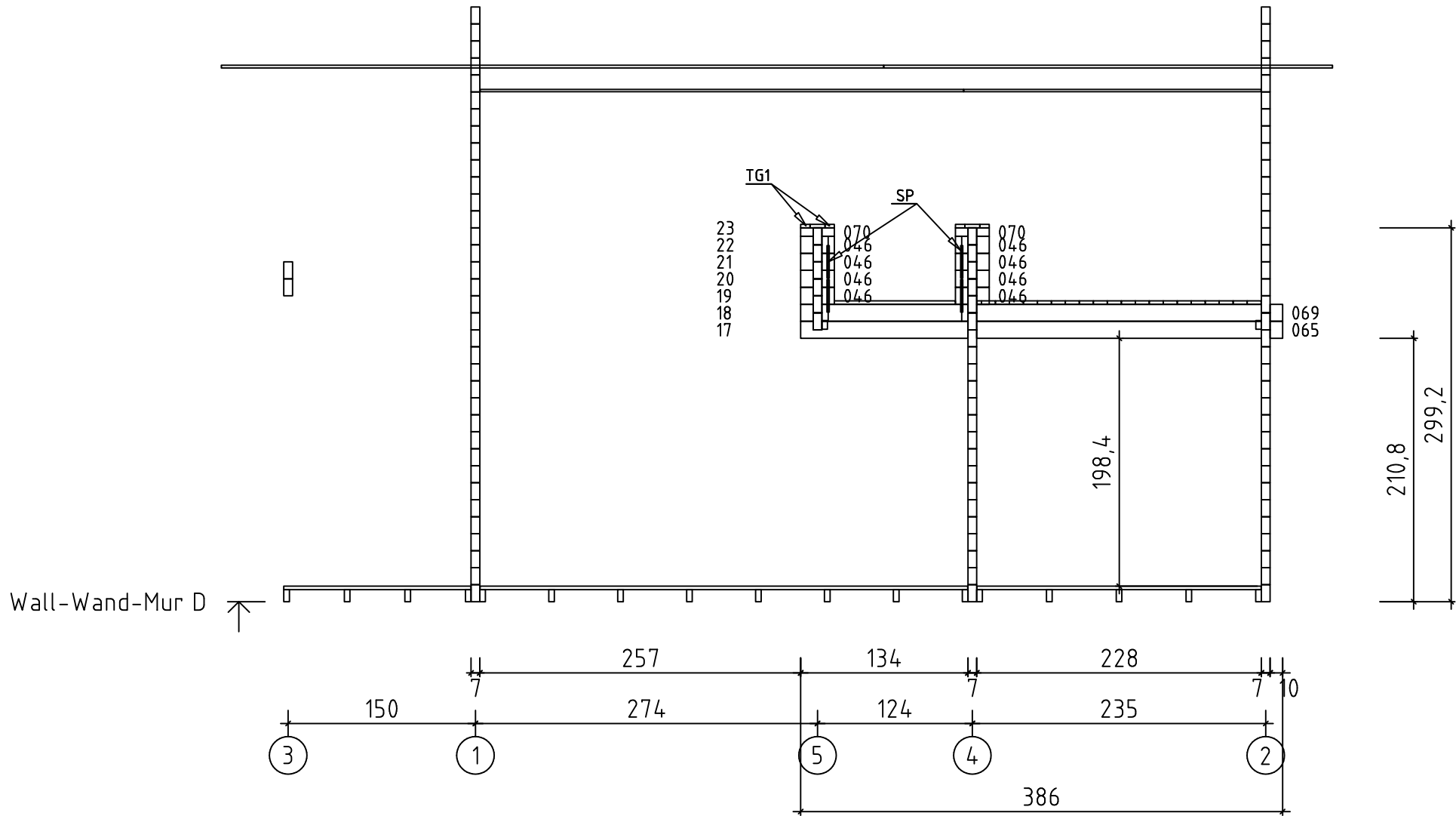

Grossglockner 70, Art.No.7011141

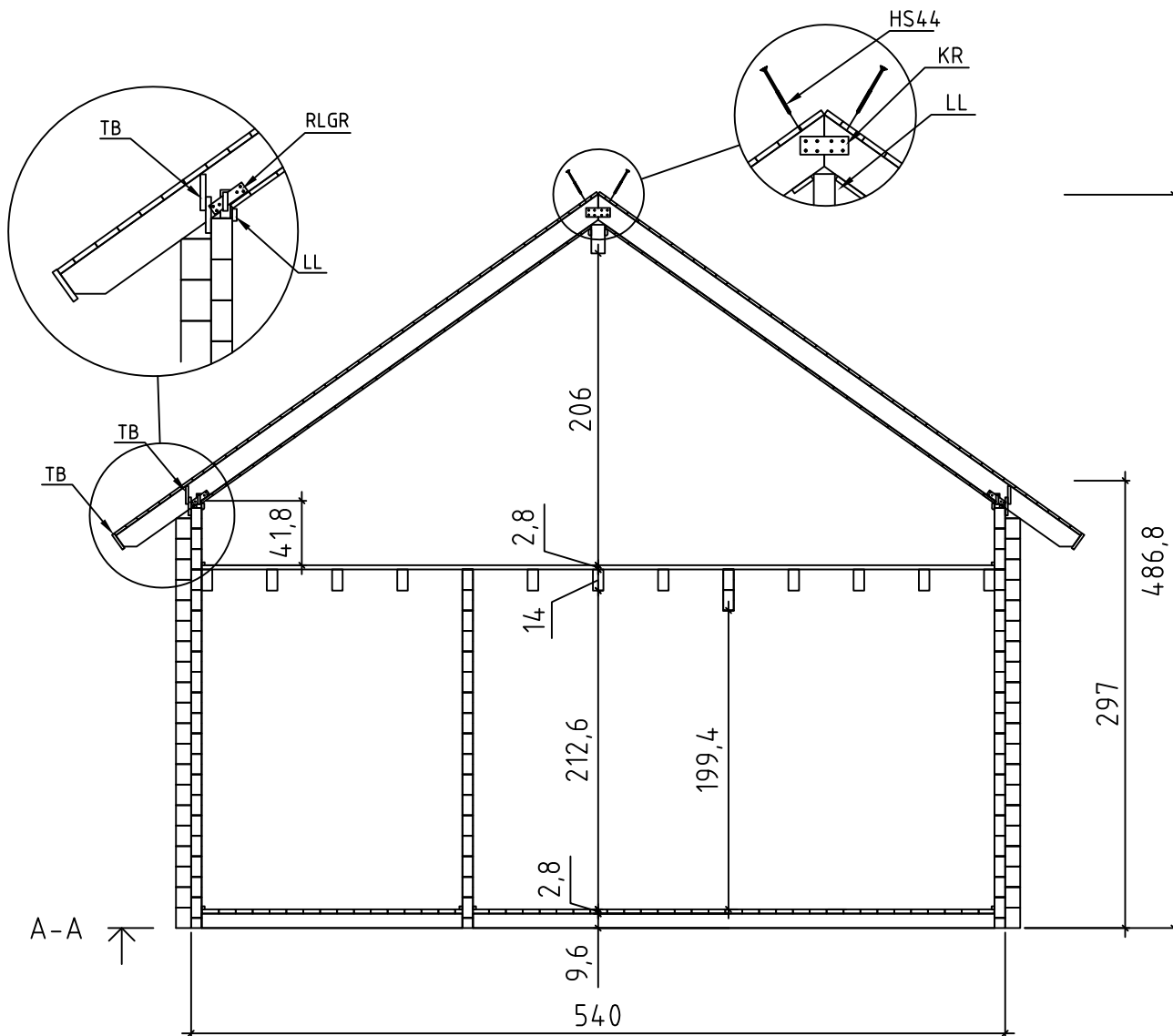

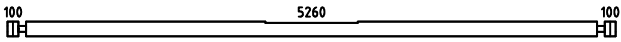
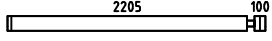

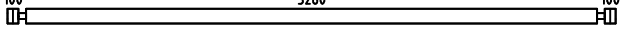
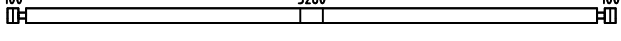
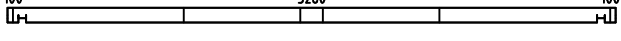
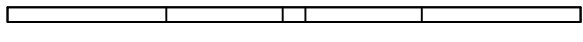
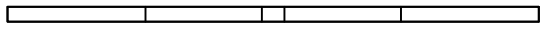
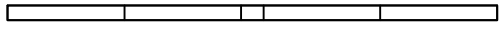
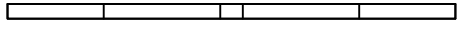
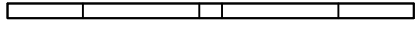
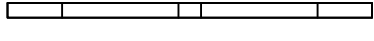
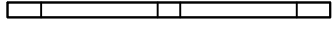
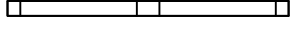
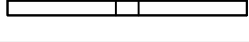
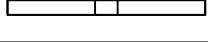
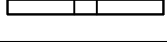
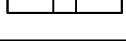

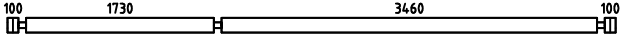
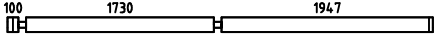



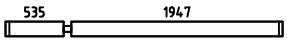
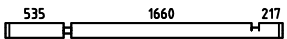
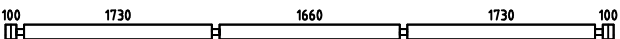
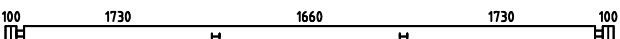
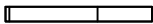



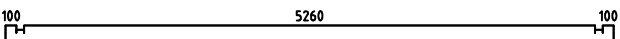
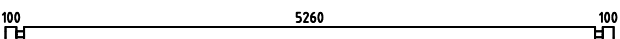
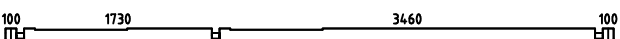

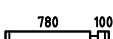
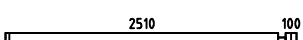
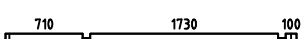
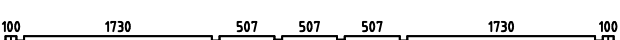
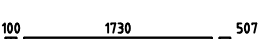
Grossglockner 70, Art.No.7011141

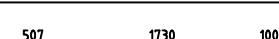

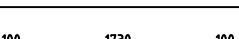



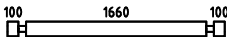
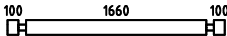
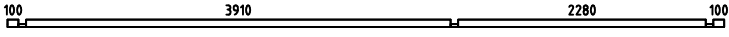
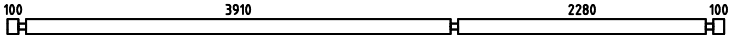
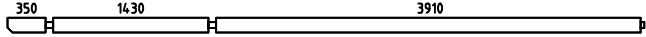
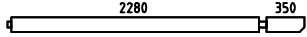
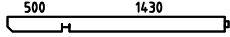
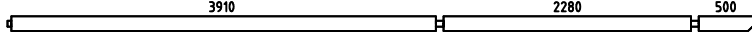
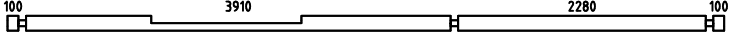
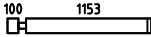
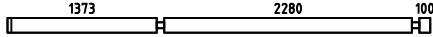
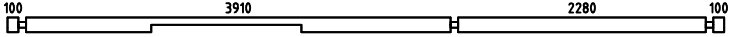
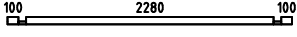
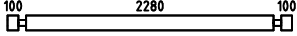
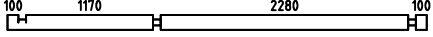
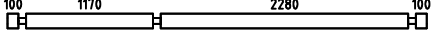
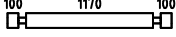
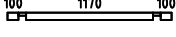
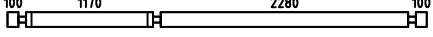

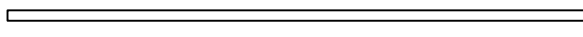
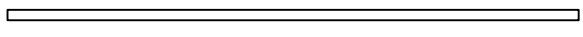
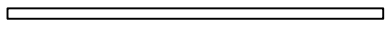
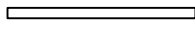
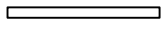













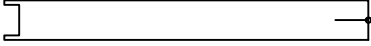

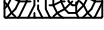
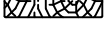
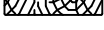
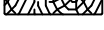

Pos	Grossglockner 70, Art.No.7011141 Piece list - Stückliste - Liste des pieces	Q.	P (mm)	L (mm)
001		1	70x136	5600
002		4	70x136	2375
003		26	70x136	683
004		26	70x136	583
005		2	70x136	5600
006		4	70x136	5600
007		2	70x136	5600
008		2	70x136	5277
009		2	70x136	4893
010		2	70x136	4509
011		2	70x136	4125
012		2	70x136	3741
013		1	70x136	3357
014		1	70x136	2972
015		1	70x136	2588
016		1	70x136	2204
017		1	70x136	1820
018		2	70x136	1436
019		2	70x136	1052
020		4	70x136	289
021		4	70x136	97
022		8	70x136	5600
023		3	70x136	3917
024		8	70x136	757
025		5	70x136	705

Pos	Grossglockner 70, Art.No.7011141 Piece list - Stückliste - Liste des pieces	Q.	P (mm)	L (mm)
026		4	70x136	2552
027		1	70x136	2552
028		1	70x136	5600
029		1	70x136	5600
030		2	70x136	1348
031		2	70x136	1156
032		2	70x136	964
033		2	70x136	772
034		2	70x136	580
035		1	70x136	5600
036		1	70x136	5600
037		1	70x136	5600
038		15	70x136	270
039		15	70x136	950
040		14	70x136	2680
041		1	70x136	2680
042		1	70x136	5600
043		1	70x136	2477
044		1	70x78	507
045		1	70x136	2477
046		10	70x136	270
047		12	70x136	270
048		2	70x136	2070
049		2	70x136	270
050		2	70x136	1909

Pos	Grossglockner 70, Art.No.7011141 Piece list - Stückliste - Liste des pieces	Q.	P (mm)	L (mm)
051		3	70x136	2000
052		1	70x136	2000
053		2	70x68	6600
054		27	70x136	6600
055		2	70x136	5865
056		2	70x136	2735
057		2	70x136	2035
058		2	70x136	6865
059		1	70x136	6600
060		7	70x136	1323
061		7	70x136	3893
062		1	70x136	6600
063		1	70x68	2620
064		15	70x136	2620
065		2	70x136	3860
066		1	70x136	3860
067		2	70x136	1510
068		1	70x68	1510
069		1	70x136	3860
070		2	70x68	270
IAR5	FOUNDATION - FUNDAMENT - FONDATION 	3	45x96	5310
IAR4	FOUNDATION - FUNDAMENT - FONDATION 	8	45x96	5260
IAR3	FOUNDATION - FUNDAMENT - FONDATION 	6	45x96	3460
IAR2	FOUNDATION - FUNDAMENT - FONDATION 	6	45x96	1730
IAR1	FOUNDATION - FUNDAMENT - FONDATION 	2	45x95	1400

Pos	Grossglockner 70, Art.No.7011141 Piece list - Stückliste - Liste des pieces	Q.	P (mm)	L (mm)
LT1	MEZZANINE FLOOR JOISTS -HALBGESCHOSS BALKEN - SOLIVES DE PLANCHER MEZZANINE 	1	90x190	8900
LT2	MEZZANINE FLOOR JOISTS -HALBGESCHOSS BALKEN - SOLIVES DE PLANCHER MEZZANINE 	2	70x70	90
VT3	MEZZANINE FLOOR JOISTS -HALBGESCHOSS BALKEN - SOLIVES DE PLANCHER MEZZANINE 	2	70x140	3520
VT1	MEZZANINE FLOOR JOISTS -HALBGESCHOSS BALKEN - SOLIVES DE PLANCHER MEZZANINE 	6	70x140	2280
VT2	MEZZANINE FLOOR JOISTS -HALBGESCHOSS BALKEN - SOLIVES DE PLANCHER MEZZANINE 	2	70x140	1170
VT4	MEZZANINE FLOOR JOISTS -HALBGESCHOSS BALKEN - SOLIVES DE PLANCHER MEZZANINE 	4	45x70	1730
VT5	MEZZANINE FLOOR JOISTS -HALBGESCHOSS BALKEN - SOLIVES DE PLANCHER MEZZANINE 	2	45x70	1660
SR1	RAFTER - DACHSPARREN - CHEVRON 	36	70x140	3921
STP	CEILING BOARDS - DECKENBRETTER - VOLIGES SOUS PLAFOND 	29	111x15	4303
STP	CEILING BOARDS - DECKENBRETTER - VOLIGES SOUS PLAFOND 	29	111x15	3873
STP	CEILING BOARDS - DECKENBRETTER - VOLIGES SOUS PLAFOND 	29	111x15	2383
STP	CEILING BOARDS - DECKENBRETTER - VOLIGES SOUS PLAFOND 	29	111x15	1953
PTL	FLOOR BOARDS - FUSSBODENBRETTER - LAME DE PLANCHER 	21	112x28	5256
PTL	FLOOR BOARDS - FUSSBODENBRETTER - LAME DE PLANCHER 	47	112x28	3906
PTL	FLOOR BOARDS - FUSSBODENBRETTER - LAME DE PLANCHER 	39	112x28	2276
PTL	FLOOR BOARDS - FUSSBODENBRETTER - LAME DE PLANCHER 	8	112x28	2275
PTL	FLOOR BOARDS - FUSSBODENBRETTER - LAME DE PLANCHER 	11	112x28	1656
	ROOF BOARDS - DACHBRETTER - VOLIGES 	88	90x18	5305
	ROOF BOARDS - DACHBRETTER - VOLIGES 	88	90x18	3595
SV2	TERRACE BOARDS - TERRASSENBRETTER - PLANCHER DE TERRASSE 	42	120x28	1500
	FLOOR FILLET-FUSSBODENLEISTE - CORNIERE DE FINITION DU PLANCHER 		18x18	55.3 m.
LL	CEILING FILLET - DECKELEISTE - PROFIL DE FINITION POUR SOUS PLAFOND 		15x40	37.8 m.
DPL	ROOFING FELT FILLET - DACHPAPPENLEISTE - BAGUETTE DE FIXATION DU FEUTRE BITUMEUX 	32	18x58	5000
M12	TREADED ROD M12 - GEWINDESTANGE M12 - TIGE FILETÉE M12 	6		890
M12	TREADED ROD M12 - GEWINDESTANGE M12 - TIGE FILETÉE M12 	6		2000

Pos	Grossglockner 70, Art.No.7011141 Piece list - Stückliste - Liste des pieces	Q.	P (mm)	L (mm)
LPL	FIXING FILLET - FIXIRUNGSLEISTE - PROFIL DE FIXATION 	4	20x70	610
LPL	FIXING FILLET - FIXIRUNGSLEISTE - PROFIL DE FIXATION 	4	20x70	650
LPL	FIXING FILLET - FIXIRUNGSLEISTE - PROFIL DE FIXATION 	3	20x70	800
LPL	FIXING FILLET - FIXIRUNGSLEISTE - PROFIL DE FIXATION 	2	20x70	876
LPL	FIXING FILLET - FIXIRUNGSLEISTE - PROFIL DE FIXATION 	4	20x70	1050
LPL	FIXING FILLET - FIXIRUNGSLEISTE - PROFIL DE FIXATION 	4	20x70	1060
LPL	FIXING FILLET - FIXIRUNGSLEISTE - PROFIL DE FIXATION 	2	20x70	1334
LPL	FIXING FILLET - FIXIRUNGSLEISTE - PROFIL DE FIXATION 	4	20x70	1729
LPL	FIXING FILLET - FIXIRUNGSLEISTE - PROFIL DE FIXATION 	6	20x70	2000
SWE1	DOORSTEP - SWELLE - SEUIL DE PORTE 	1	28x74	970
P	POST - PFOSTEN - POTEAU 	1	120x120	1705
P	POST - PFOSTEN - POTEAU 	3	120x120	2310
TB	EAVES BOARD - TRAUFBRETT - BANDEAU DE TOIT 	16	18x120	282
TB	EAVES BOARD - TRAUFBRETT - BANDEAU DE TOIT 	24	18x120	570
TB	EAVES BOARD - TRAUFBRETT - BANDEAU DE TOIT 	2	18x120	3595
TB	EAVES BOARD - TRAUFBRETT - BANDEAU DE TOIT 	2	18x120	5305
TBE12	FIXING FILLET - FIXIRUNGSLEISTE - PROFIL DE FIXATION 	4	28x34	260
TBE6	FIXING FILLET FOR WINDOW - FIXIRUNGSLEISTE FÜR FENSTER - PROFIL DE FIXATION DES FENETRES 	4	28x34	650
TBE6	FIXING FILLET FOR WINDOW - FIXIRUNGSLEISTE FÜR FENSTER - PROFIL DE FIXATION DES FENETRES 	2	28x34	884
TBE6	FIXING FILLET FOR WINDOW - FIXIRUNGSLEISTE FÜR FENSTER - PROFIL DE FIXATION DES FENETRES 	2	28x34	1050
TBE6	FIXING FILLET FOR WINDOW - FIXIRUNGSLEISTE FÜR FENSTER - PROFIL DE FIXATION DES FENETRES 	4	28x34	1729
TBE6	FIXING FILLET FOR DOOR - FIXIRUNGSLEISTE FÜR TÜR - PROFIL DE FIXATION DES PORTES 	6	28x34	1990
TG1	GUARD-RAIL FOR TERRACE - TERRASSEN GELÄNDER - MAIN COURANTE DE TERRASSE 	6	28x120	75
TG1	GUARD-RAIL FOR TERRACE - TERRASSEN GELÄNDER - MAIN COURANTE DE TERRASSE 	1	28x120	1120
TG1	GUARD-RAIL FOR TERRACE - TERRASSEN GELÄNDER - MAIN COURANTE DE TERRASSE 	2	28x120	1616

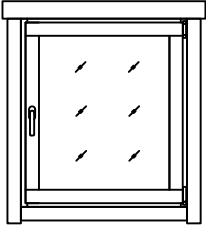
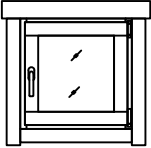
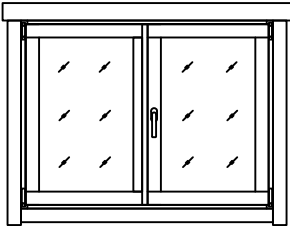
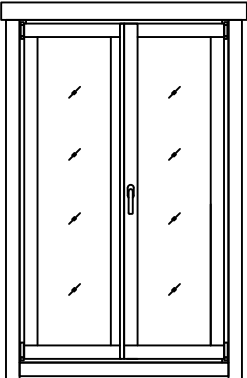
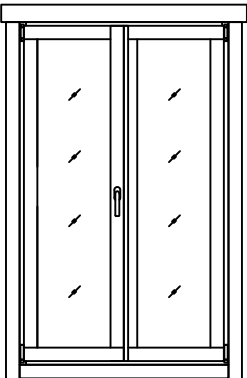
Pos	Grossglockner 70, Art.No.7011141 Piece list - Stückliste - Liste des pieces	Q.	P (mm)	L (mm)
	WINDOW-FENSTER-FENETRE 916x1050 	1		
	WINDOW-FENSTER-FENETRE 650x650 	2		
	WINDOW-FENSTER-FENETRE 1374x1050 	1		
	WINDOW-FENSTER-FENETRE 1100x1729 	1		
	WINDOW-FENSTER-FENETRE 1100x1729 	1		

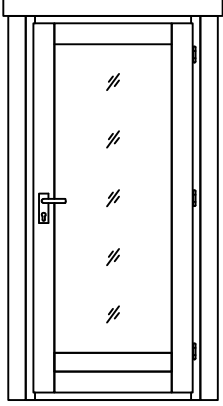
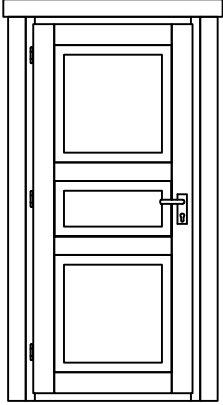
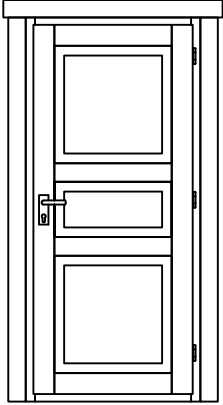
Pos	Grossglockner 70, Art.No.7011141 Piece list - Stückliste - Liste des pieces	Q.	P (mm)	L (mm)
	DOOR-TÜR-PORTE 84x200 	1		
	DOOR-TÜR-PORTE 84x200 	1		
	DOOR-TÜR-PORTE 84x200 	1		