

Stradbroke 3.9x7 70mm
Art. Nr. 7014302

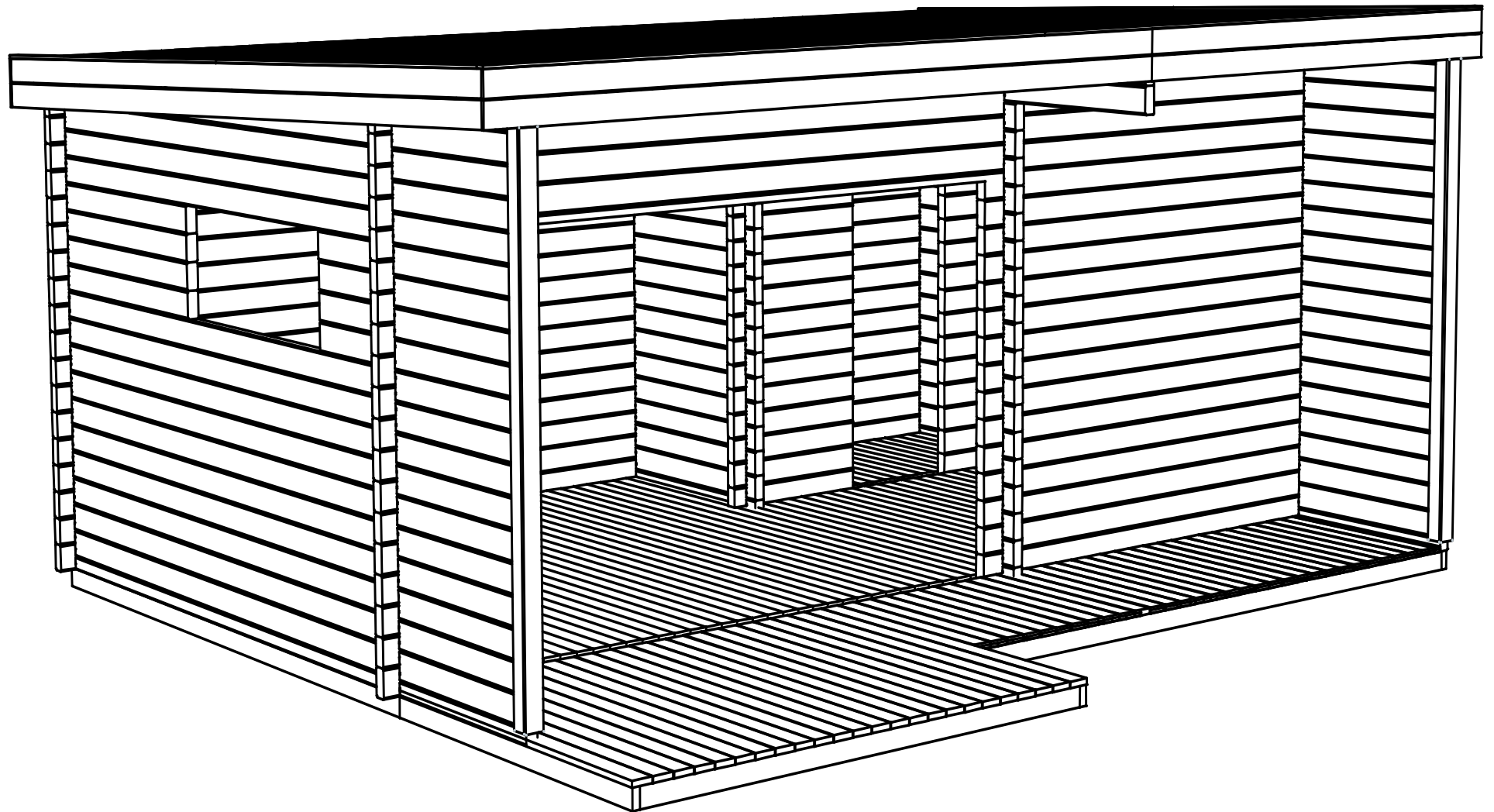

Stradbroke 3.9x7 70mm, Art.Nr.7014302
GROUNDPLAN

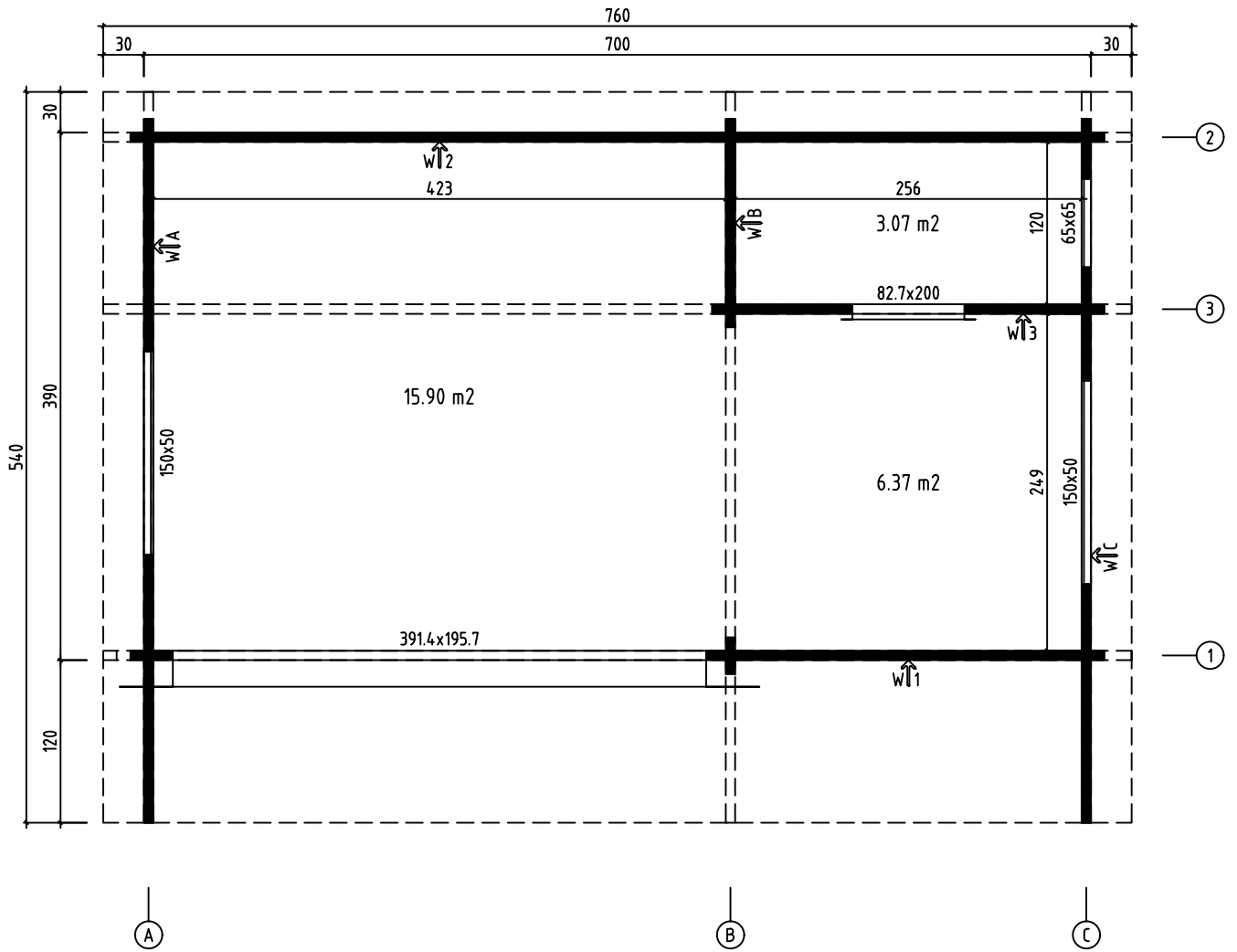

Stradbroke 3.9x7 70mm, Art.Nr.7014302
FOUNDATION

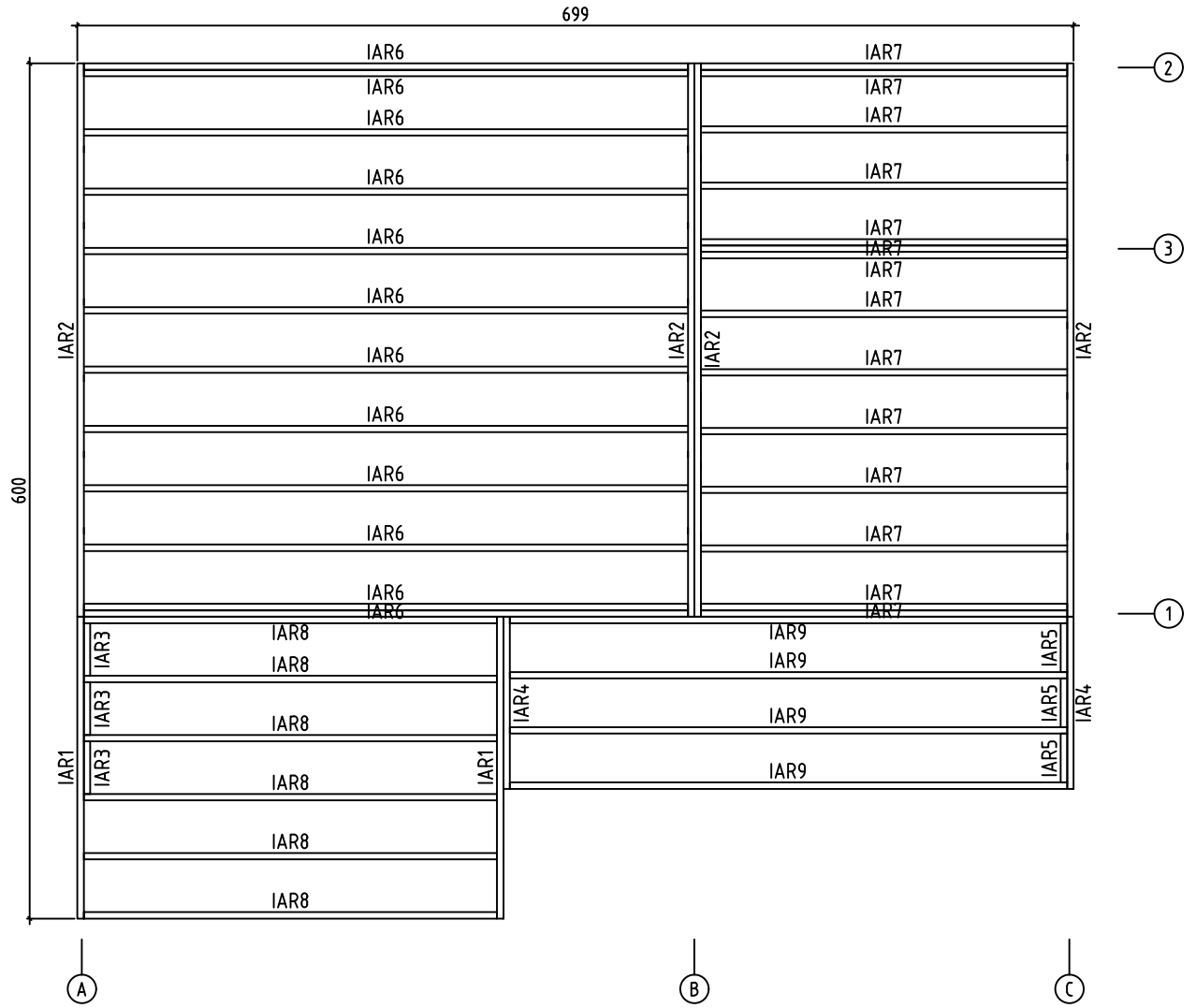

Stradbroke 3.9x7 70mm, Art.Nr.7014302
FOUNDATION

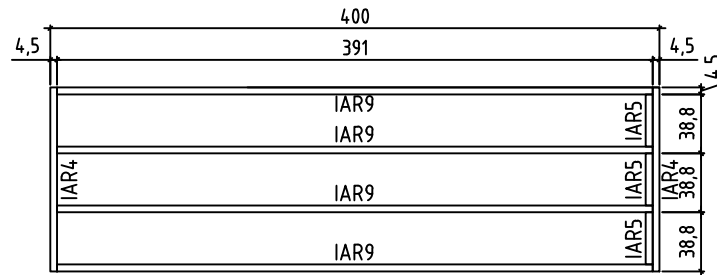
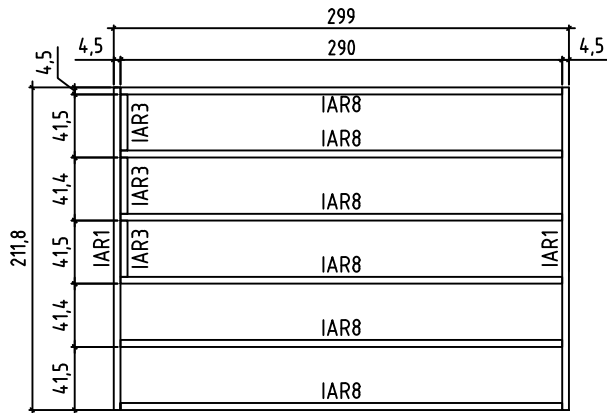
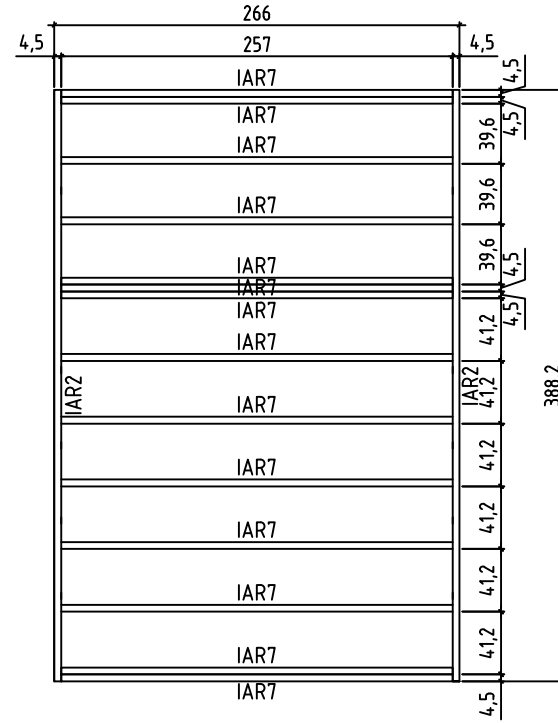
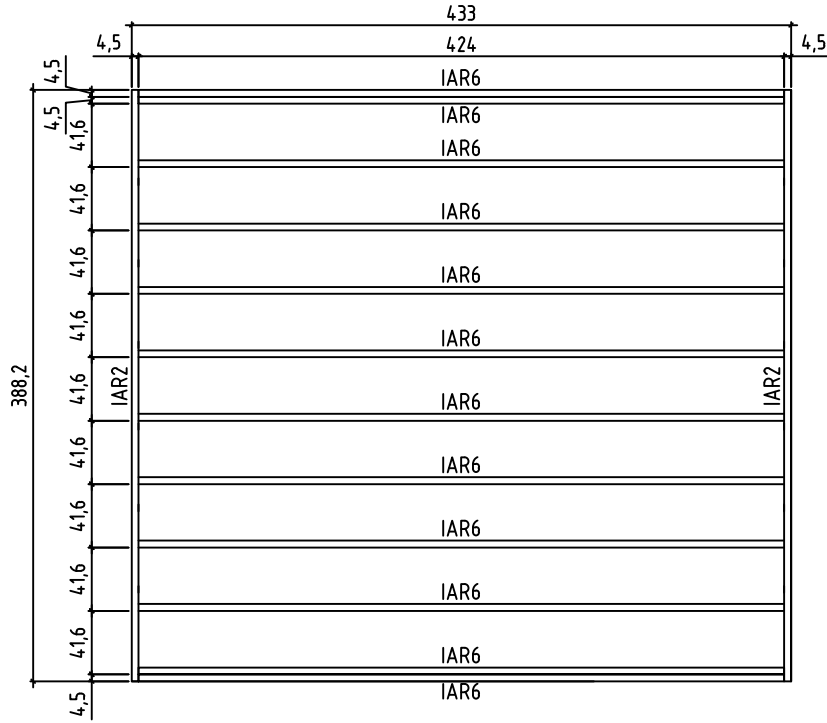
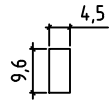

Stradbroke 3.9x7 70mm, Art.Nr.7014302

FLOOR BOARDS
TERRACE BOARDS

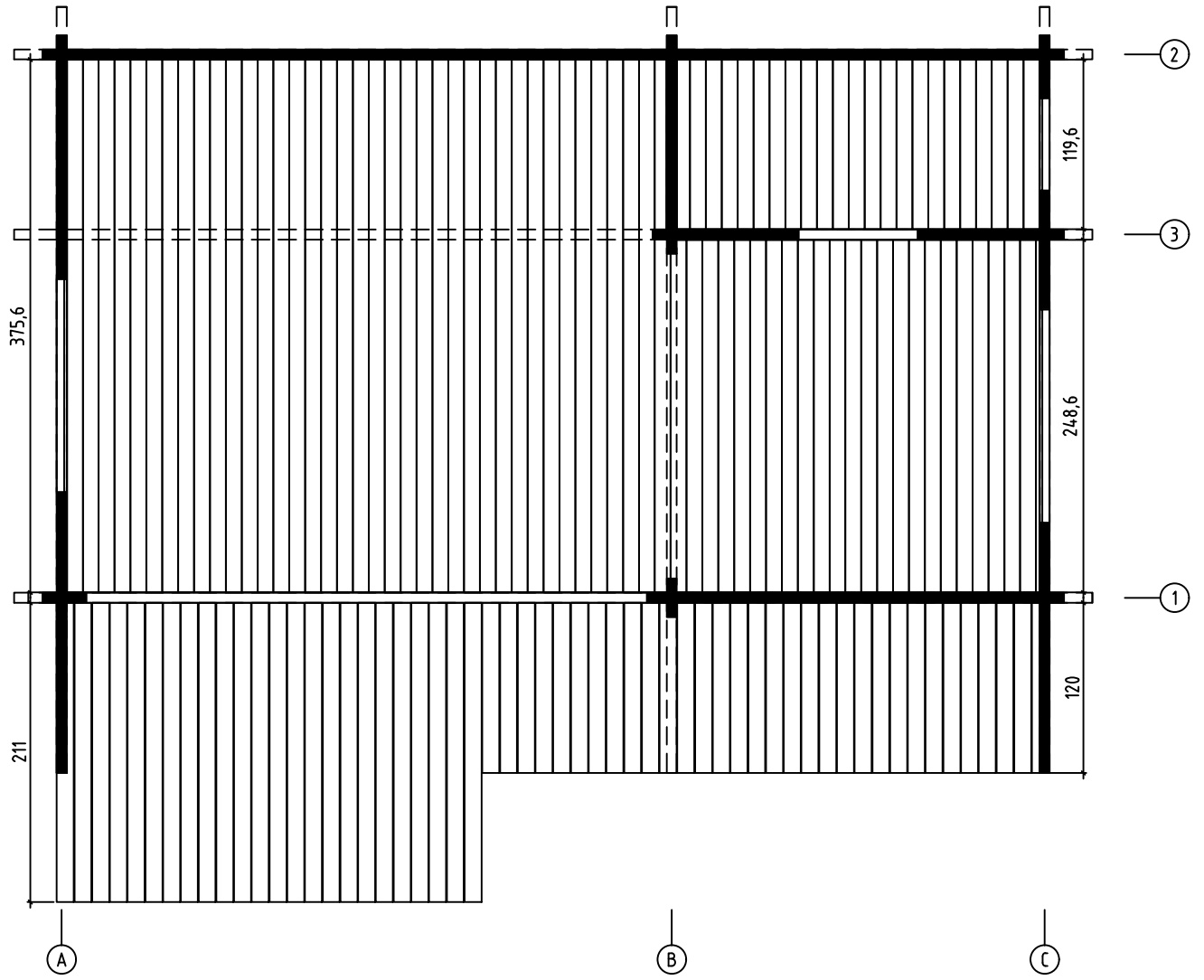

Stradbroke 3.9x7 70mm, Art.Nr.7014302

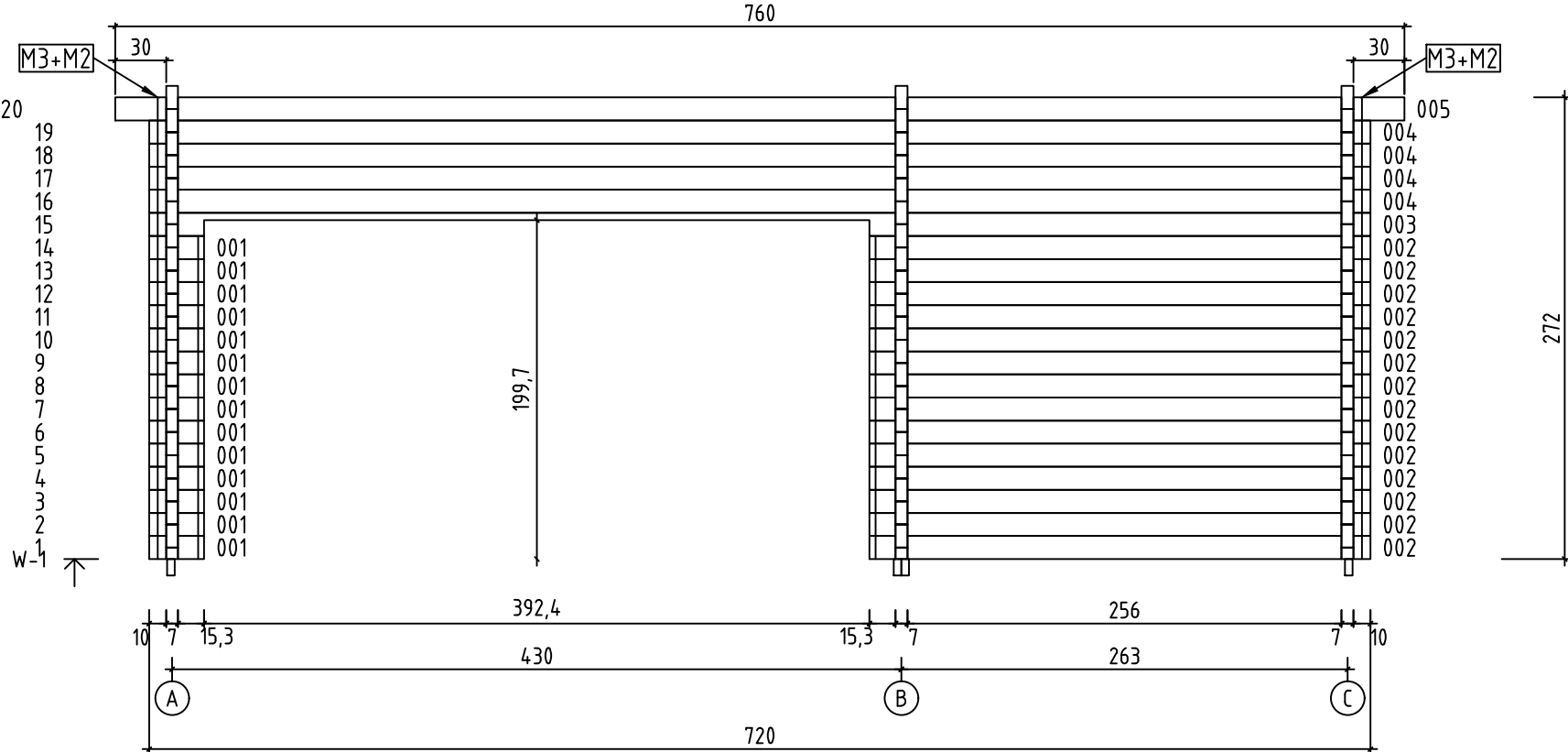

Stradbroke 3.9x7 70mm, Art.Nr.7014302

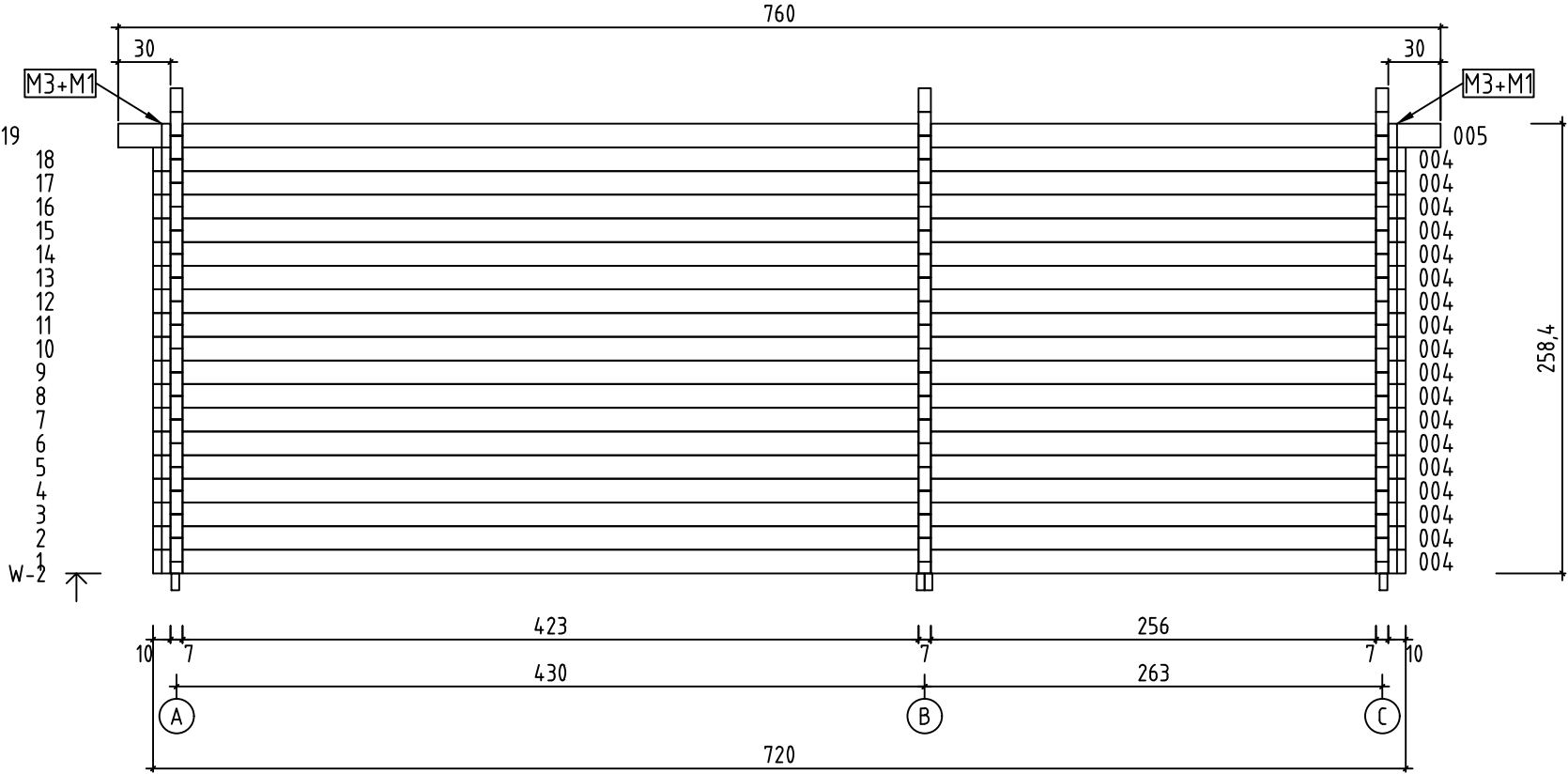



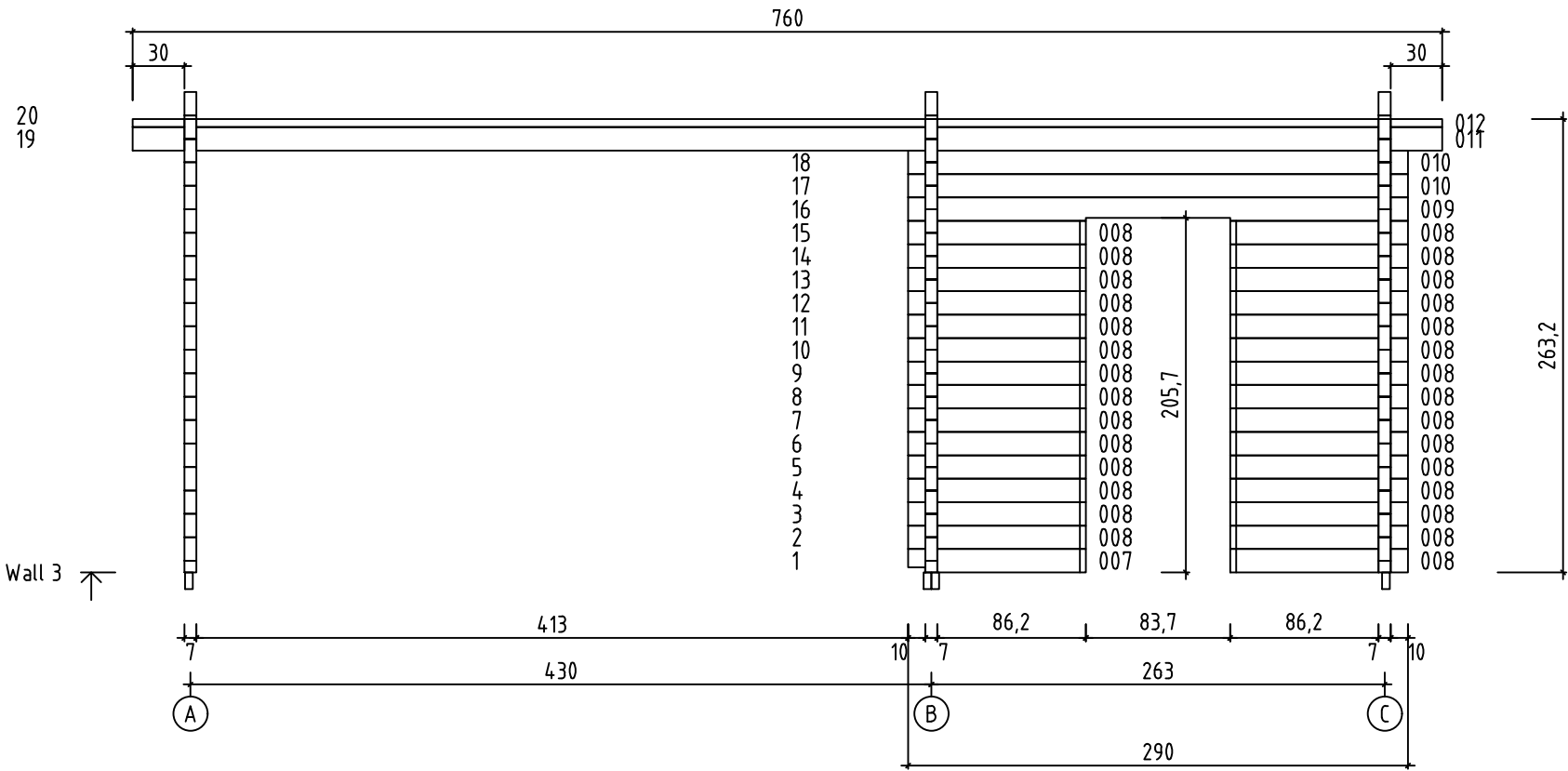

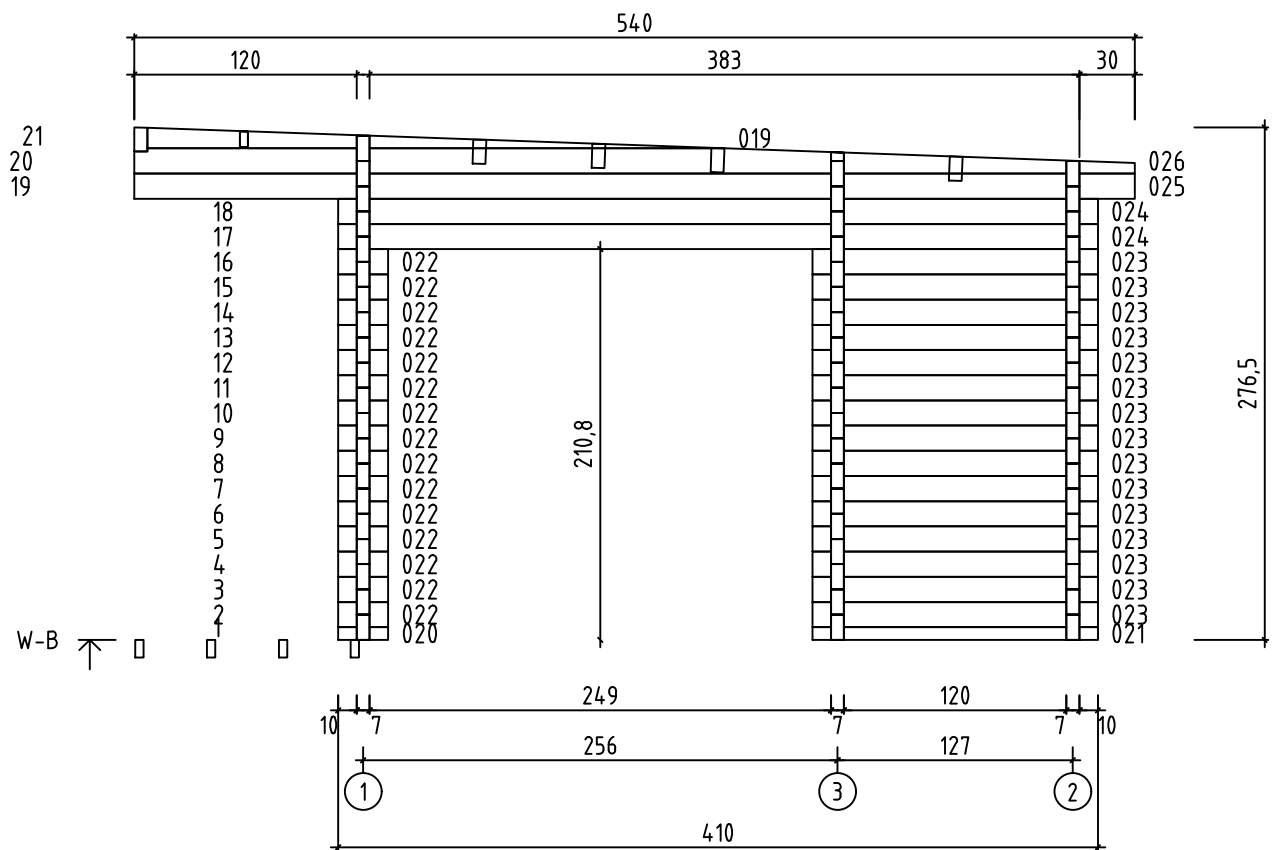
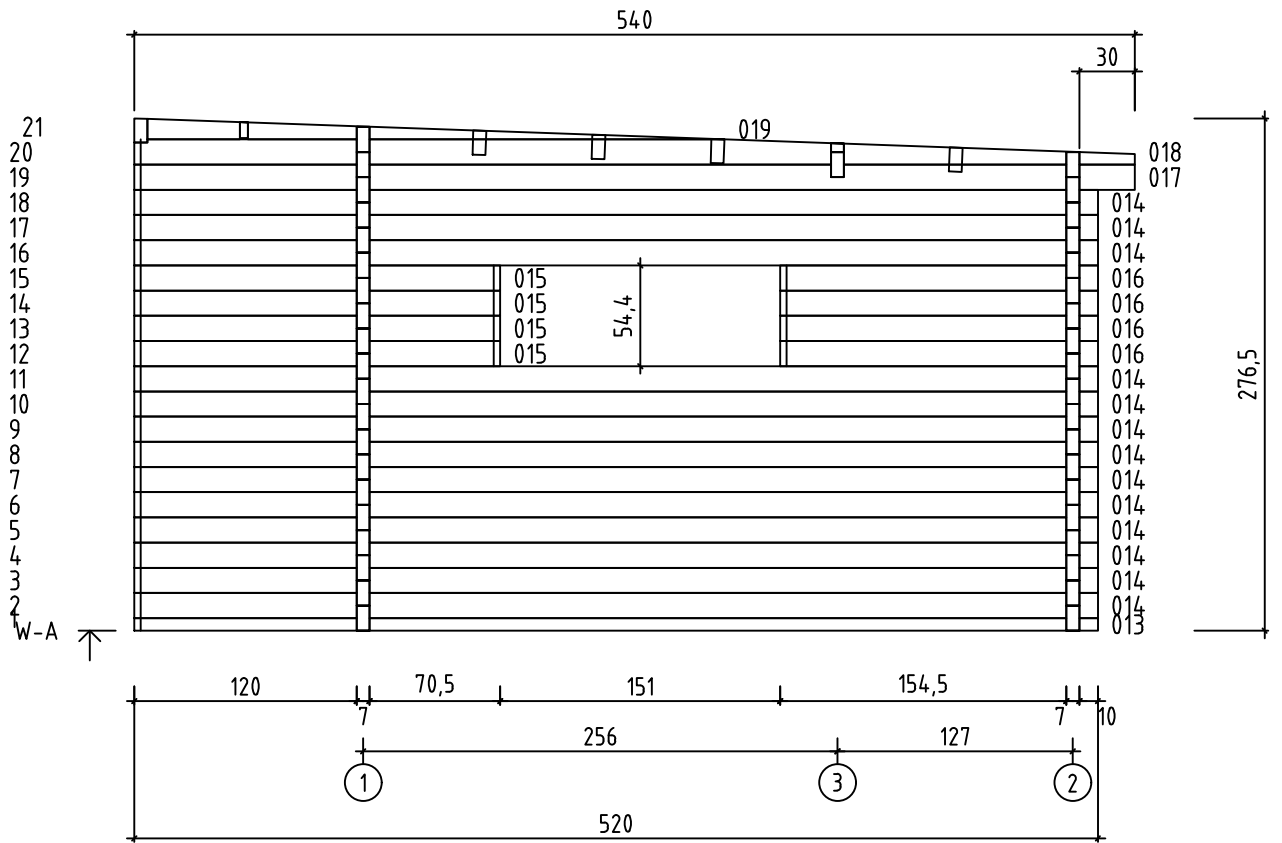

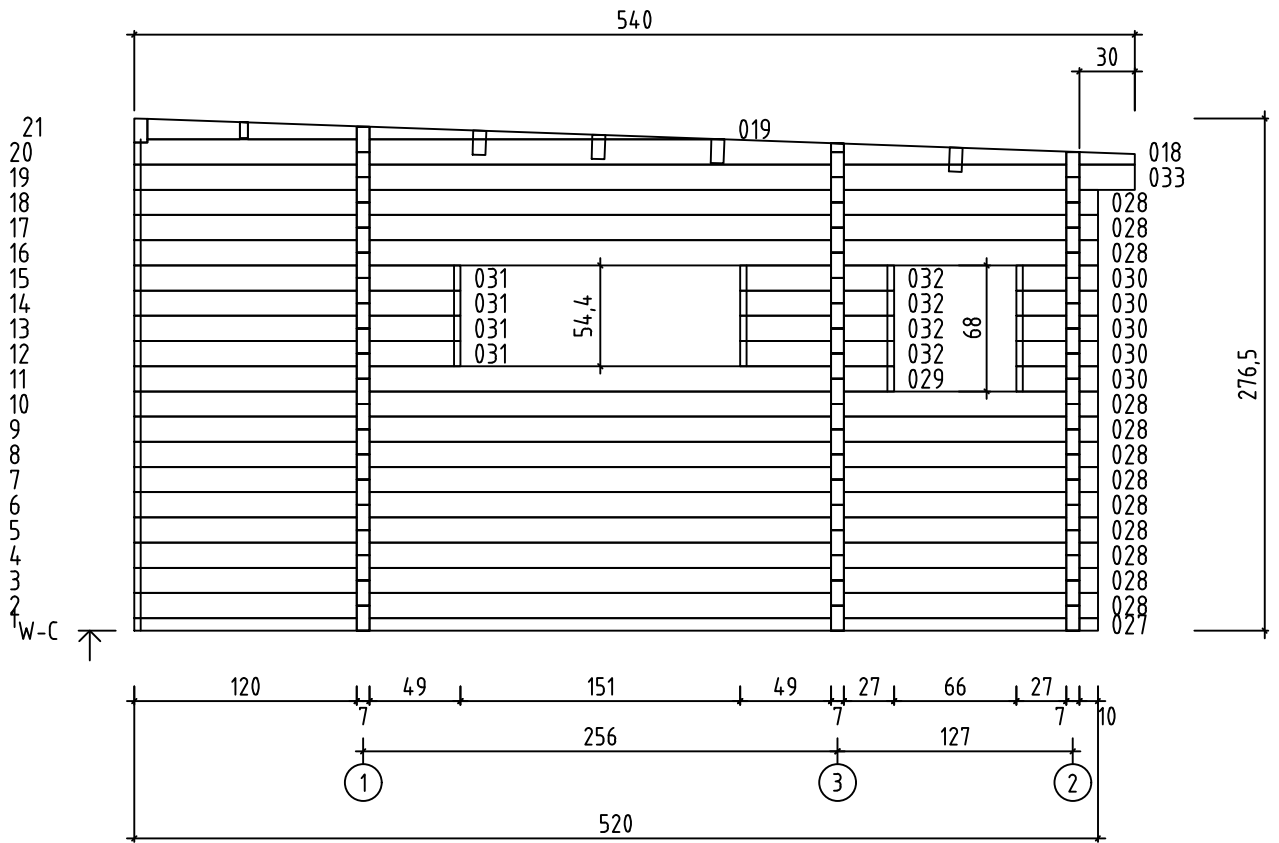
Stradbroke 3.9x7 70mm, Art.Nr.7014302

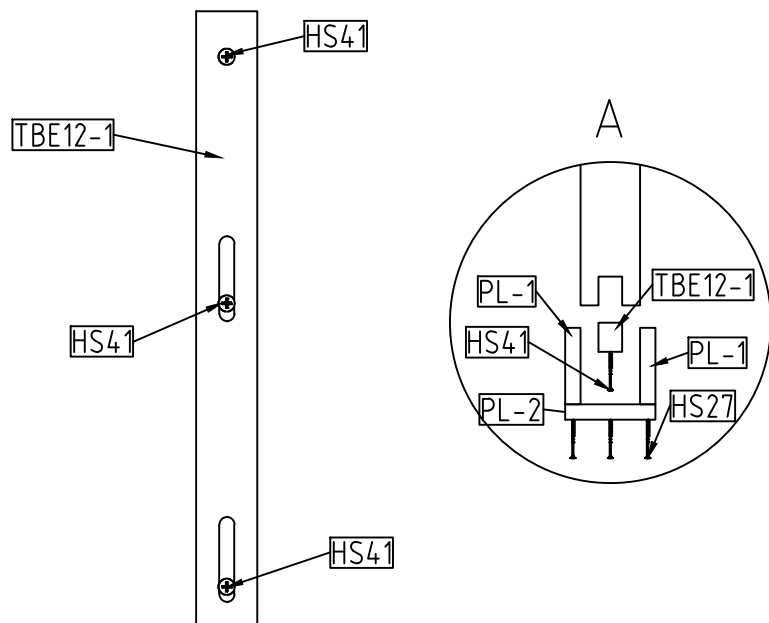
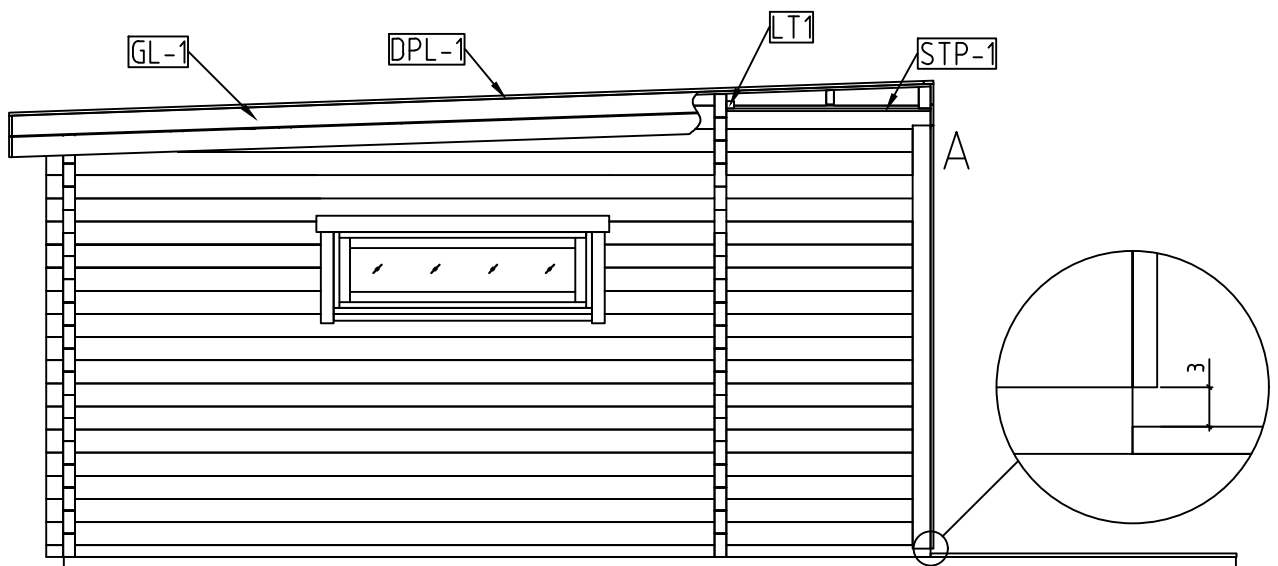
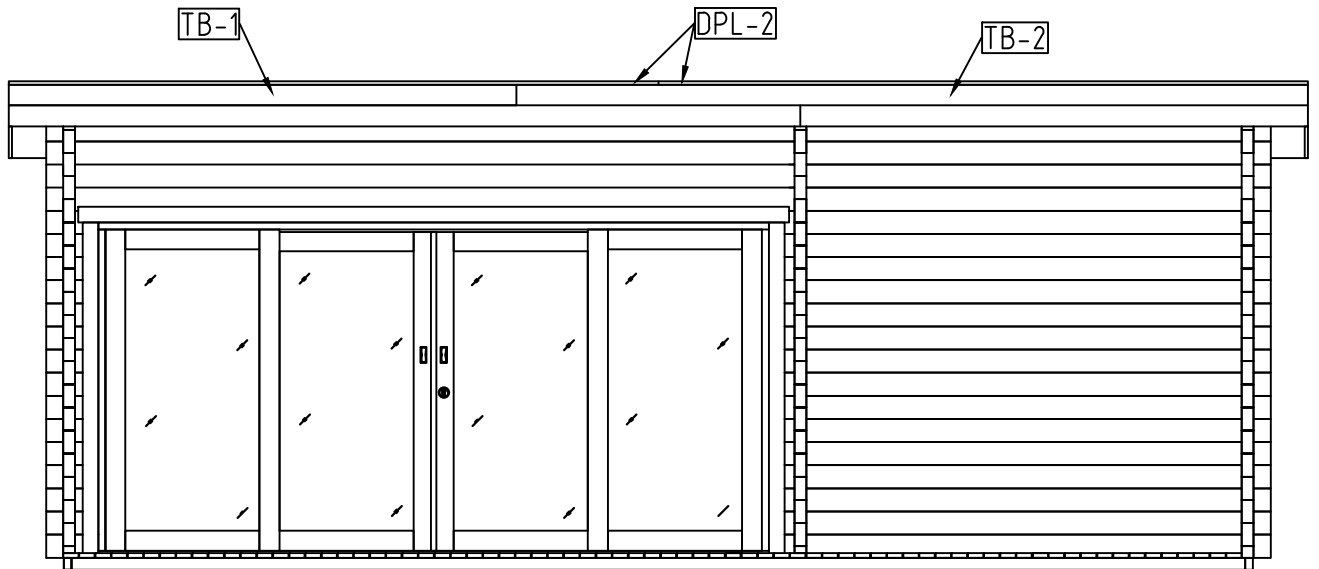



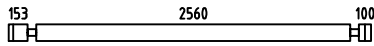
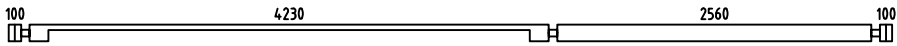
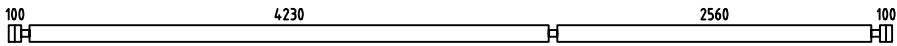
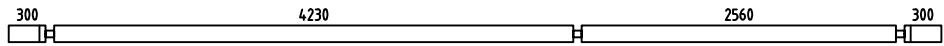
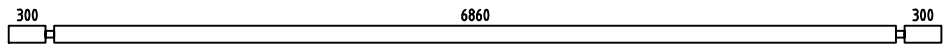
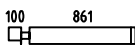
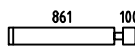
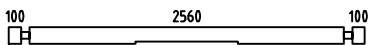
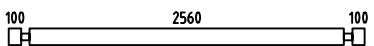
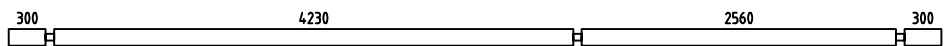
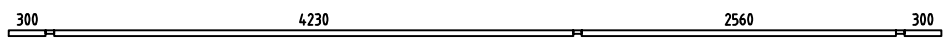
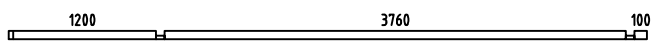
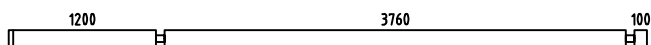
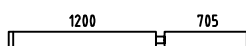
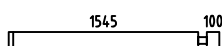

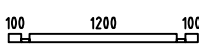

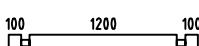
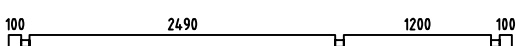
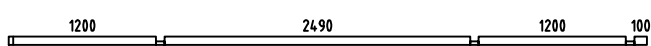
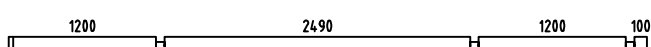

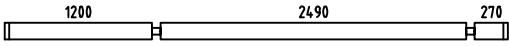

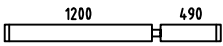
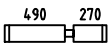
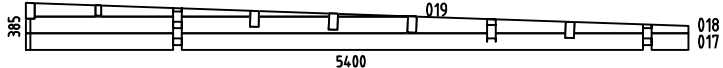
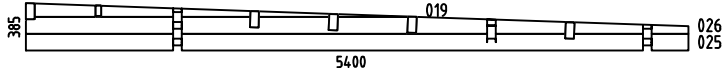
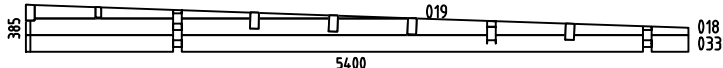
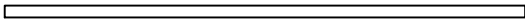
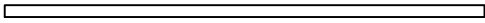
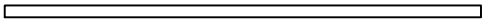
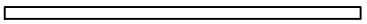
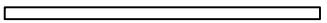
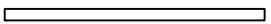
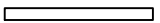



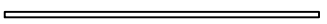
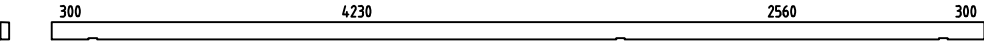
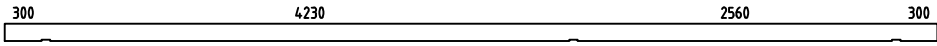
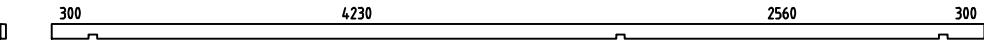
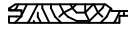





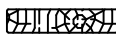



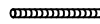









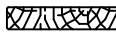
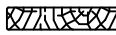









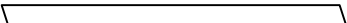



















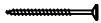
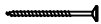





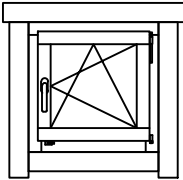
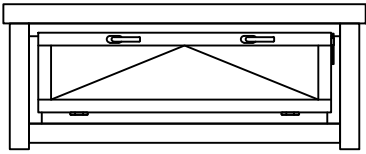
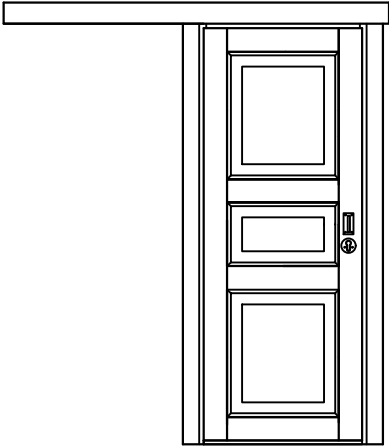

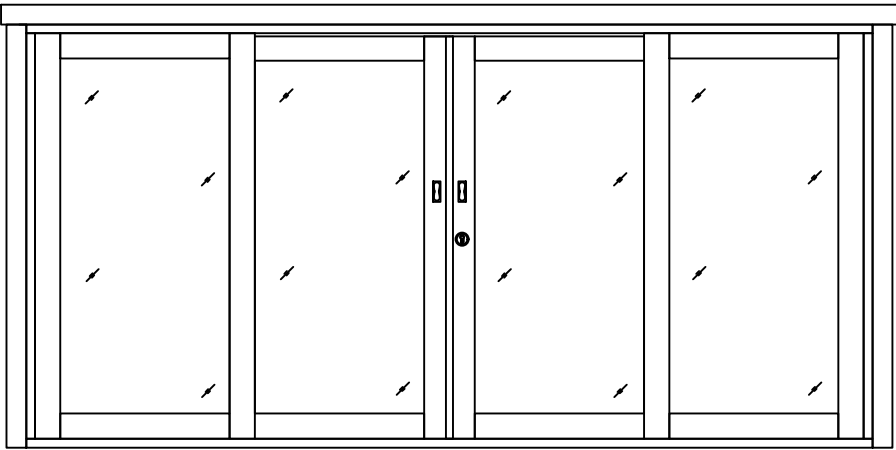
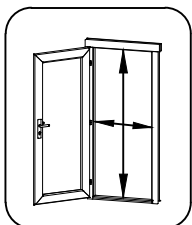

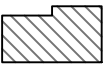

Pos	Stradbroke 3.9x7 70mm, Art.Nr.7014302 Piece list	Q.	P (mm)	L (mm)
001		14	70x136	323
002		14	70x136	2953
003		1	70x136	7200
004		22	70x136	7200
005		2	70x136	7600
006	SPARE PART 	1	70x136	7600
007		1	70x136	1031
008		29	70x136	1031
009		1	70x136	2900
010		2	70x136	2900
011		1	70x136	7600
012		1	70x48	7600
013		1	70x68	5200
014		13	70x136	5200
015		4	70x136	1975
016		4	70x136	1715
020		1	70x68	270
021		1	70x68	1540
022		15	70x136	270
023		15	70x136	1540
024		2	70x136	4100
027		1	70x68	5200
028		12	70x136	5200

Pos	Stradbroke 3.9x7 70mm, Art.Nr.7014302 Piece list	Q.	P (mm)	L (mm)
029		1	70x136	4100
030		5	70x136	440
031		4	70x136	1760
032		4	70x136	830
WA-1		1		
WB-1		1		
WC-1		1		
IAR6	FOUNDATION 	12	45x96	4240
IAR9	FOUNDATION 	4	45x96	3910
IAR2	FOUNDATION 	4	45x96	3883
IAR8	FOUNDATION 	6	45x96	2900
IAR7	FOUNDATION 	14	45x96	2570
IAR1	FOUNDATION 	2	45x96	2118
IAR4	FOUNDATION 	2	45x96	1208
IAR3	FOUNDATION 	3	45x96	370
IAR5	FOUNDATION 	3	45x96	343
LT1	CEILING JOISTS 	1	45x45	4230
LT2	CEILING JOISTS 	1	45x45	2560
A-PR3	ROOF BEAM 	1	70x140	7600
A-PR1	ROOF BEAM 	4	70x140	7600
A-PR2	ROOF BEAM 	1	44x120	7600
STP-1	CEILING BOARDS 	64	111x15	1200
PTL-1	FLOOR BOARDS 	39	112x28	3756

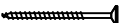
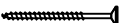
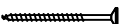
Pos	Stradbroke 3.9x7 70mm, Art.Nr.7014302 Piece list	Q.	P (mm)	L (mm)
PTL-2	FLOOR BOARDS 	24	112x28	2486
PTL-3	FLOOR BOARDS 	23	112x28	1196
RB-1	ROOF BOARDS 	86	90x18	5403
SV2-1	TERRACE BOARDS 	25	120x28	2110
SV2-2	TERRACE BOARDS 	32	120x28	1200
FL-1	FLOOR FILLET 		15x40	29 m.
DPL-1	ROOFING FELT FILLET 	4	18x58	2690
DPL-2	ROOFING FELT FILLET 	2	18x58	3818
M1	TREADED ROD M12 	2		615
M2	TREADED ROD M12 	2		750
M3	TREADED ROD M12 	4		2000
LPL	FIXING FILLET 	4	18x70	500
LPL	FIXING FILLET 	2	18x70	614
LPL	FIXING FILLET 	2	18x70	650
LPL	FIXING FILLET 	4	18x70	1464
SWE1-1	DOORSTEP 	1	28x74	837
PL-1	BATTEN 	4	18x90	2485
PL-2	BATTEN 	2	18x106	2485
TB-1	EAVES BOARD 	4	18x120	2983
TB-2	EAVES BOARD 	4	18x120	4653
DRV-1	ROOF EDGE REINFORCEMENT 	2	28x34	300
DRV-2	ROOF EDGE REINFORCEMENT 	1	28x34	2560
DRV-3	ROOF EDGE REINFORCEMENT 	1	28x34	4230

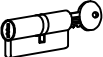
Pos	Stradbroke 3.9x7 70mm, Art.Nr.7014302 Piece list	Q.	P (mm)	L (mm)
TBE12-1	FIXING FILLET 	2	28x34	2485
TBE6	FIXING FILLET FOR WINDOW 	4	28x34	500
TBE6	FIXING FILLET FOR WINDOW 	2	28x34	650
TBE6	FIXING FILLET FOR DOOR 	2	28x34	1850
TBE6	FIXING FILLET FOR DOOR 	2	28x34	2000
GL-1	GABLE MOULDING 	4	18x120	5408
KL4	LENGTHENING BOLT FOR TREADED ROD 	4		
KL1	DRIVE NUT TREADED ROD 	4		
KL2	NUT FOR TREADED ROD 	4		
KL3	PLAIN WASHER TREADED ROD 	4		
HS83	SCREW FOR FIXING FILLET 	50	3.5x50	
HS32	SCREW FOR EAVES BOARDS 	46	3.5x50	
HS84	SCREW FOR FIXING FILLET 	40	3.5x50	
HS59	SCREW FOR DOORSTEP 	3	3.5x50	
HS16	SCREW FOR GABLE MOULDING 	50	3.5x50	
HS52	SCREW FOR FLOOR 	534	3.5x50	
NFD	SCREW FOR ROOFING FELT FILLET 	40	4x40	
HS27	SCREW FOR BATTEN 	30	4x40	
HS26	SCREW FOR ROOF EDGE REINFORCEMENT 	20	4x40	
HS40	SCREW FOR 1. WALL BEAM 	16	5x120	
HS42	SCREW FOR GABLE 	12	5x120	
HS43	SCREW FOR ROOF BEAMS 	18	5x120	
HS78	SCREW FOR POS.012 	4	5x120	

Pos	Stradbroke 3.9x7 70mm, Art.Nr.7014302 Piece list	Q.	P (mm)	L (mm)
HS39	SCREW FOR FUNDAMENT 	110	5x90	
HS81	SCREW FOR CEILING BOARD HOLDER 	15	5x90	
HS41	SCREW FOR FIXING FILLET 	6	5x90	
NF3	SCREW FOR TERRACE BOARD 	556	4.2x55	
SH70	HAMMER BLOCK 	2		
	ZN NAIL FOR FILLETS 	67		
NF2	ZN NAIL FOR ROOF 	800	2.1x50	
NF2	ZN NAIL FOR CEILING BOARDS 	192	2.1x50	
ORZ	MONTAGE SET FOR DOORS AND WINDOWS	1		
	WINDOW +LPL  650x650 2+ A.OP.cK	1		
	WINDOW +LPL  1500x500 2+ A.Ü.K	2		
	DOOR  827x2000 UL.3TV	1		

Pos	29.03.2019	Piece list - Stückliste - Liste des pièces - Elementi - Stuklijst - Tükítabel 3914x1957 TUK.1.100.TPLP.MMf7 DGP	1/1	Q	P (mm)	L (mm)
		<p>Glass size - Glasgröße - Taille de la vitre - Misura del vetro - Glas afmeting - Klaasi mõõt: 786x1616 mm Glass size - Glasgröße - Taille de la vitre - Misura del vetro - Glas afmeting - Klaasi mõõt: 786x1631 mm</p>   <p>1770x1845</p>				
1	Upper door jamb - Türrahmen oben - Cadre de porte supérieur - Telaio superiore della porta - Bovendorpel - Ukse ülemine leng		1	106x130	4080	
2	Left door jamb - Türrahmen links - Cadre de porte gauche - Telaio montante sinistro della porta - Linkerstijl deurframe - Ukse vasak leng		1	106x130	1925	
3	Right door jamb - Türrahmen rechts - Cadre de porte droit - Telaio montante destro della porta - Rechterstijl deurframe - Ukse parem leng		1	106x130	1925	
4	Doorstep - Swelle - Barre de seuil - Soglia della porta - Deurdorpel - Lävepak		1	89x40	3850	
7	Connection strip - Deckleiste - Baguette de battement - Profilo verticale della porta - Stulplijst - Kokkuvaltsiliist		1	18x32	1830	
HS5	Screw for lock covers - Schraube für schlossblenden - Vis pour set de garnitures de serrure de porte - Viti per copriserratura - Schroef voor sluitplaat slot - Kruvi lükandukse lukuplaadile		4	2.5x16		
HS4	Screw for door handle fittings - Schraube für türgriff - Vis pour fixation poignée de porte - Viti per montaggio delle maniglie - Schroef voor deurgreep (hendel) - Kruvi lükandukse käepidemele		16	3x30		
HS4	Screw for sliding door roller - Schraube für schiebetür laufrad - Vis pour ferrure de porte coulissante - Viti per rullo delle porte scorrevoli - Schroef voor schuifdeur wiel-katrol - Kruvi lükandukse ülemisele juhikule		8	3x30		
HS4	Screw for door fillet - Schraube zur befestigung türleiste - Vis pour fixation baguette d'arret de porte - Viti per massellino della porta - Schroef voor deurlijst - Kruvi ukse kokkuvaltsiliistule		5	3x30		
HS2	Screw for door jamb - Schraube für türrahmen - Vis de fixation partie haute avec montants du cadre de porte - Viti x fissaggio montanti porte - Schroef voor deurkozijn - Kruvi ukse lengile		4	5x120		
HS1	Screw for door jamb - Schraube für türrahmen - Vis de fixation partie haute avec montants du cadre de porte - Viti x fissaggio montanti porte - Schroef voor deurkozijn - Kruvi ukse lengile		4	5x90		
HS3	Screw for door jamb - Schraube für türrahmen - Vis de fixation partie haute avec montants du cadre de porte - Viti x fissaggio montanti porte - Schroef voor deurkozijn - Kruvi ukse lengile		16	5x90		
	Handle for sliding door - Muschel für schiebetür - Poignée couvette - Maniglia per porta scorrevole - Handvat / klink schuifdeur - Lükandukse käepide		4			
	Cylinder - Zylinderschloss - Barillet de porte - Cilindro (solito diserratura) - Cylinder - Lükandukse lukusüdamik		1			
LF	Roller for sliding door - Laufrad für schiebetür - Ferrure pour porte coulissante - Rullo per porta scorrevole - Wielkatrol voor schuifdeur - Lükandukse ülemine juhik		4			
	Set of door lock covers - Schlossblenden - Set de garnitures de porte - Copertura serrature - Slot sluitplaat set - Lükandukse ümar lukuplaat		2			
	Striker for barrel bolt - Hülse für grendelriegel - Gache au sol du targette - Boccola per fermo della porta - Huls voor vergrendelingsschuif - Vasturaud ukse servariivile		2			

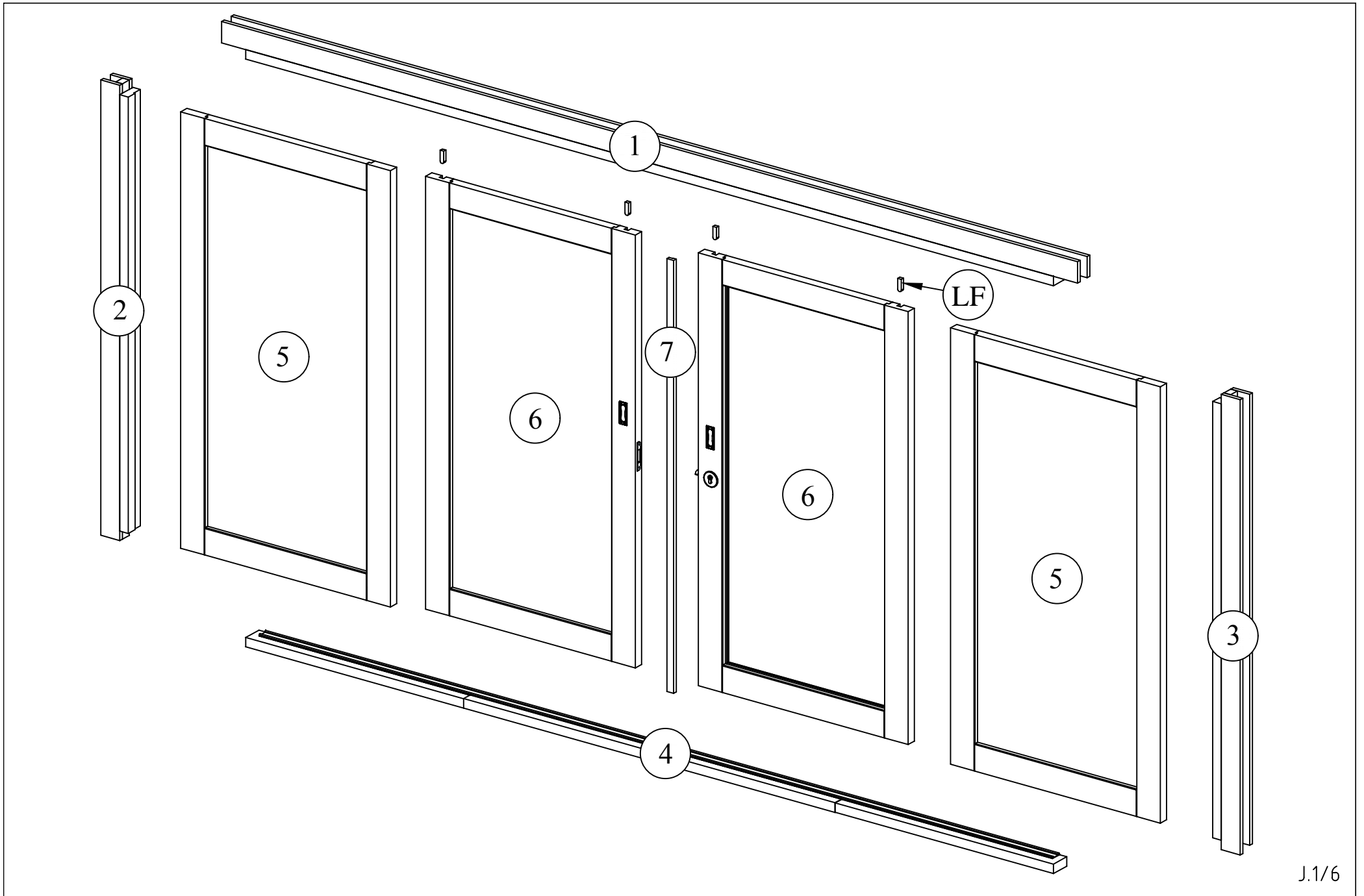

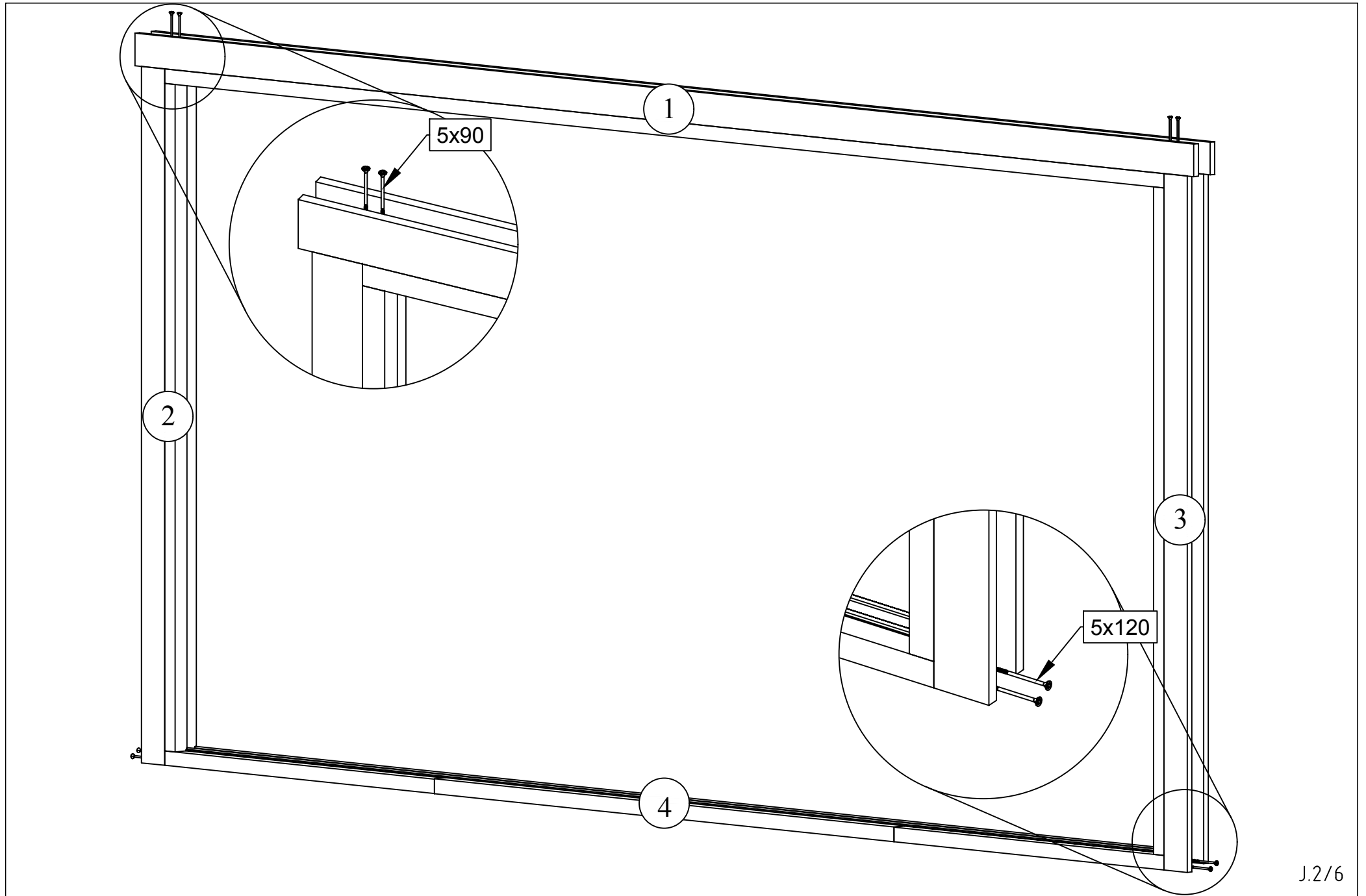

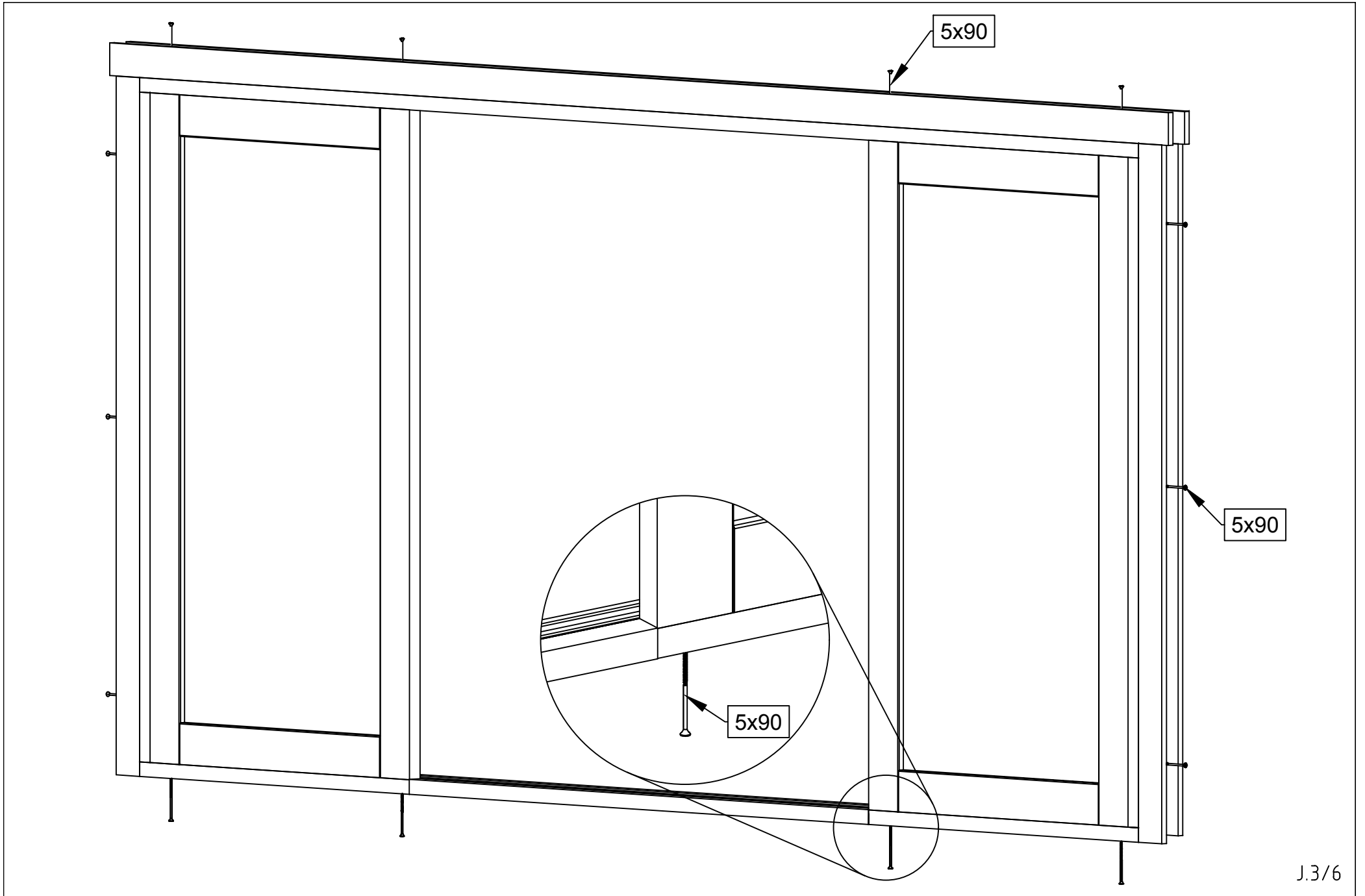

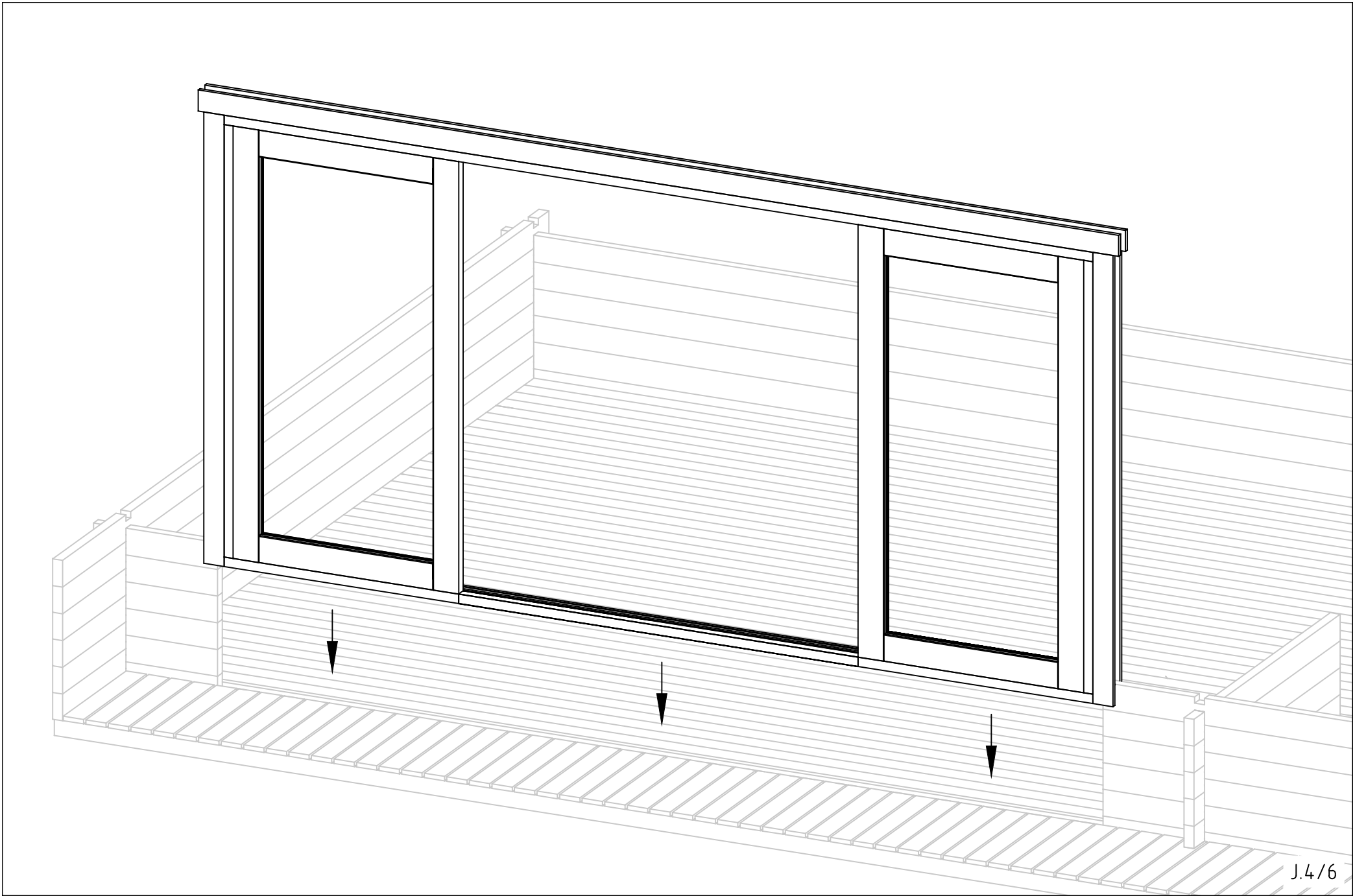

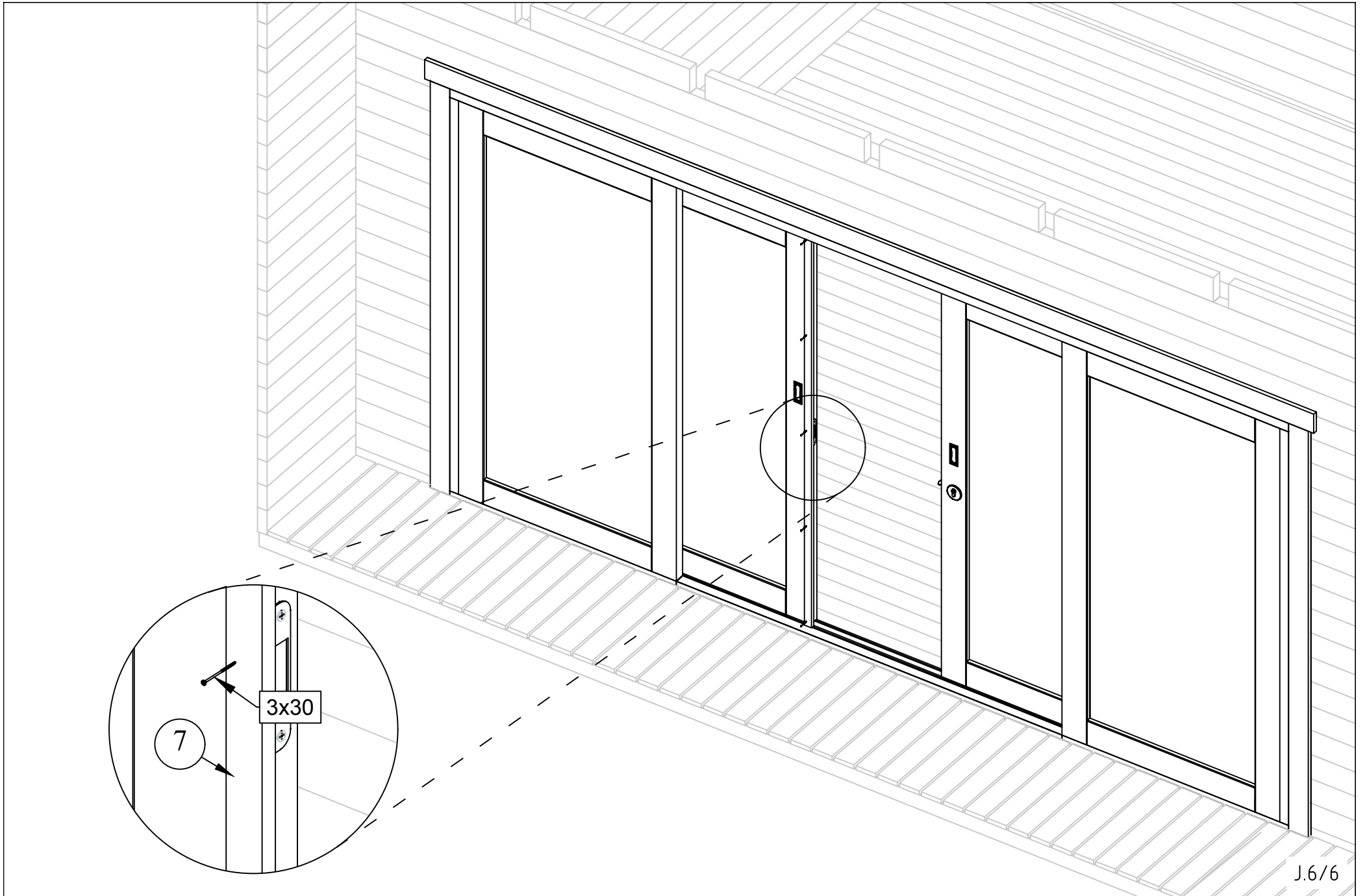

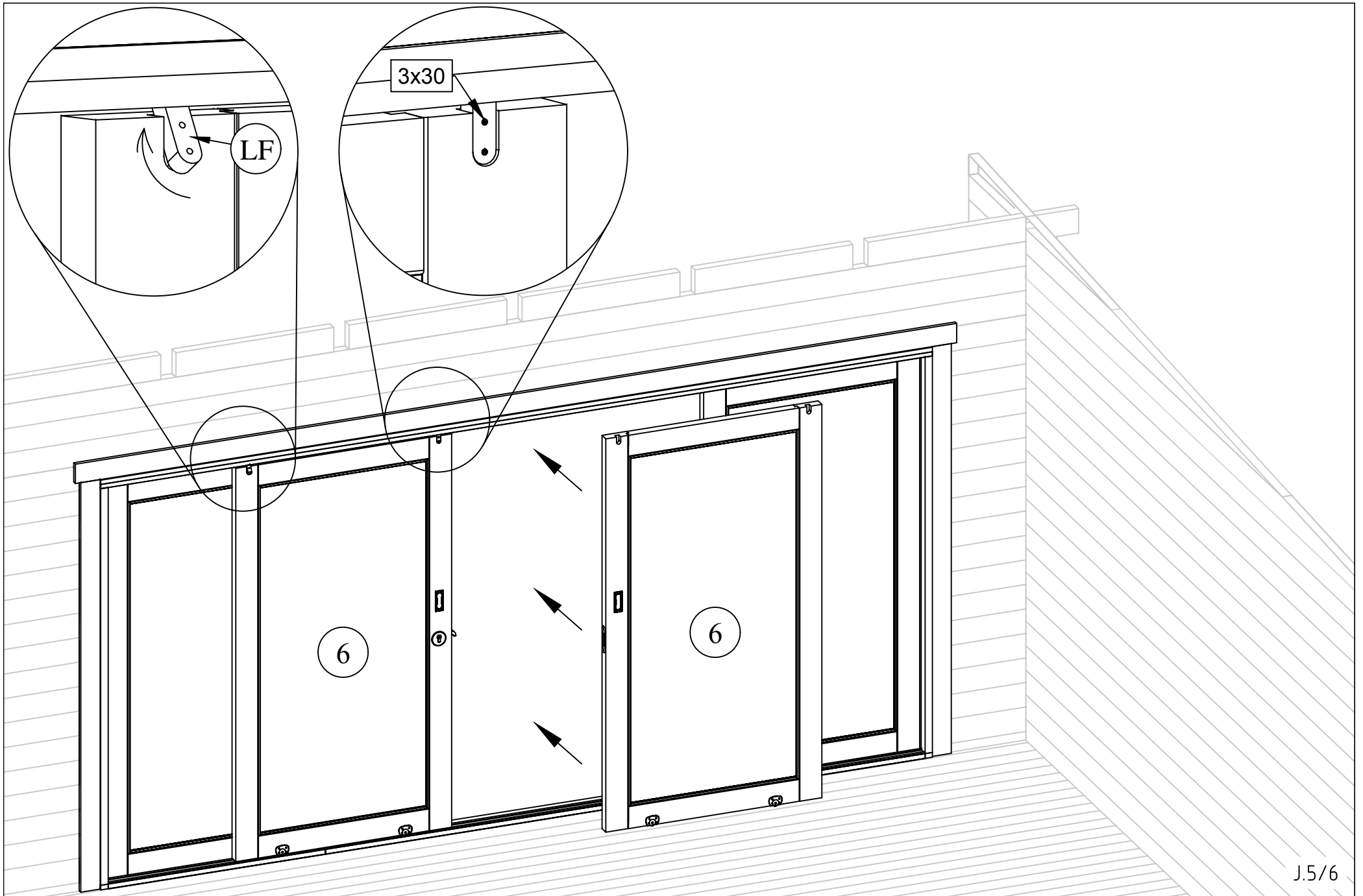

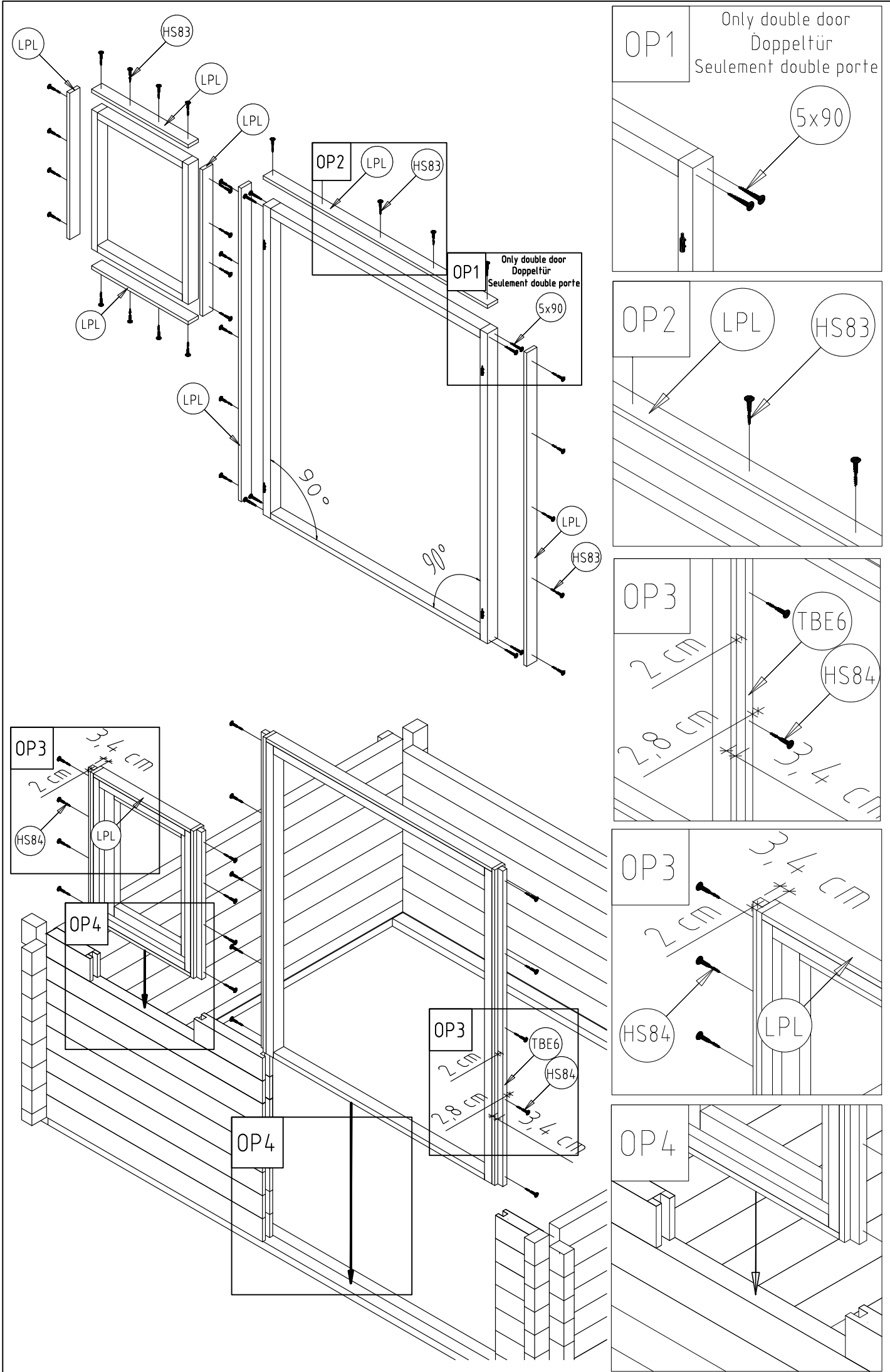

OP1 Only double door
Doppeltür
Seulement double porte

