

Orkney 4
Art.No. 704502

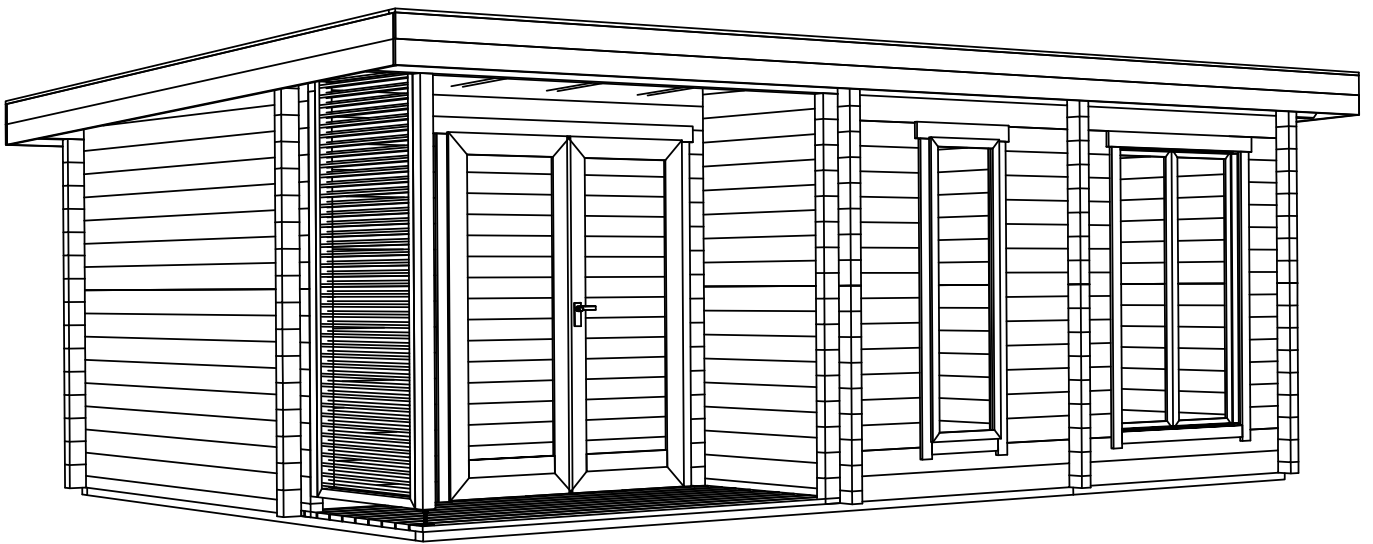

Orkney 4, Art.No.704502
Groundplan - Grundplan - Plan de masse - Planimetria - Plattegrond - Põhiplaan

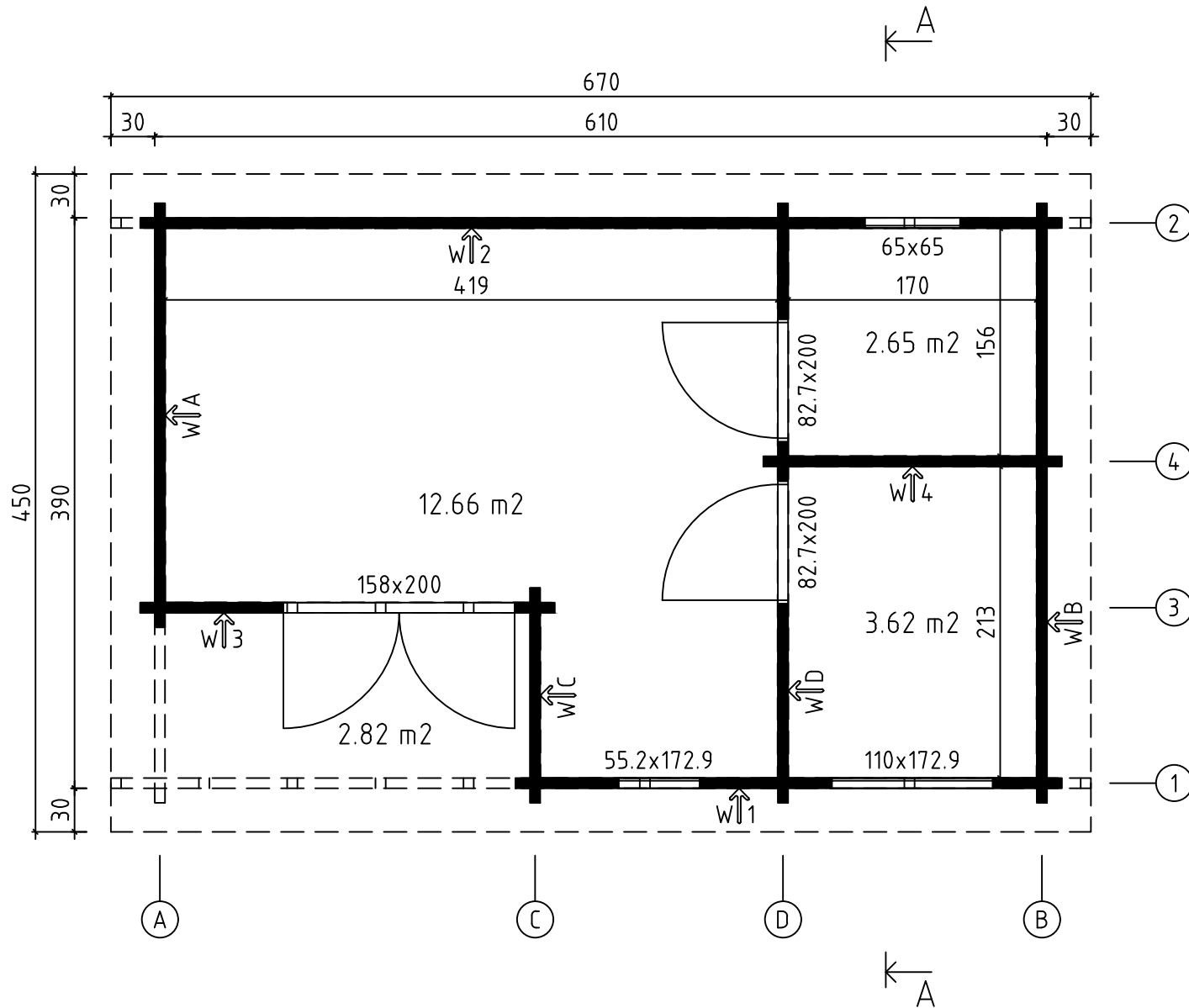

Orkney 4, Art.No.704502
 Foundation - Fundament - Fondation - Fondamenta - Fundering - Immutatud alusraam

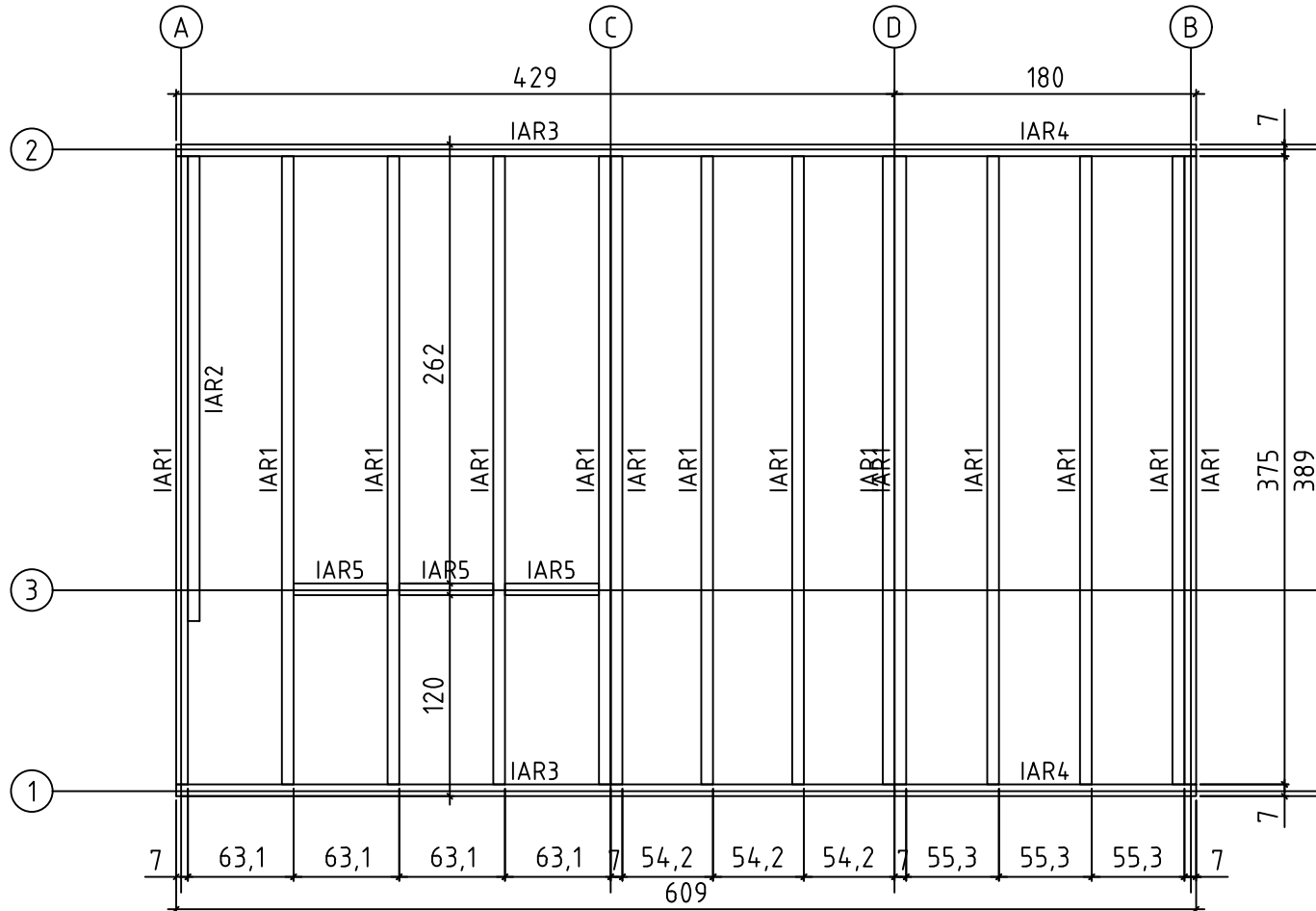

Orkney 4, Art.No.704502
Floor boards - Fussbodenbretter - Plan pose plancher - Pavimento - Vloerhout -
Põrandalaudis

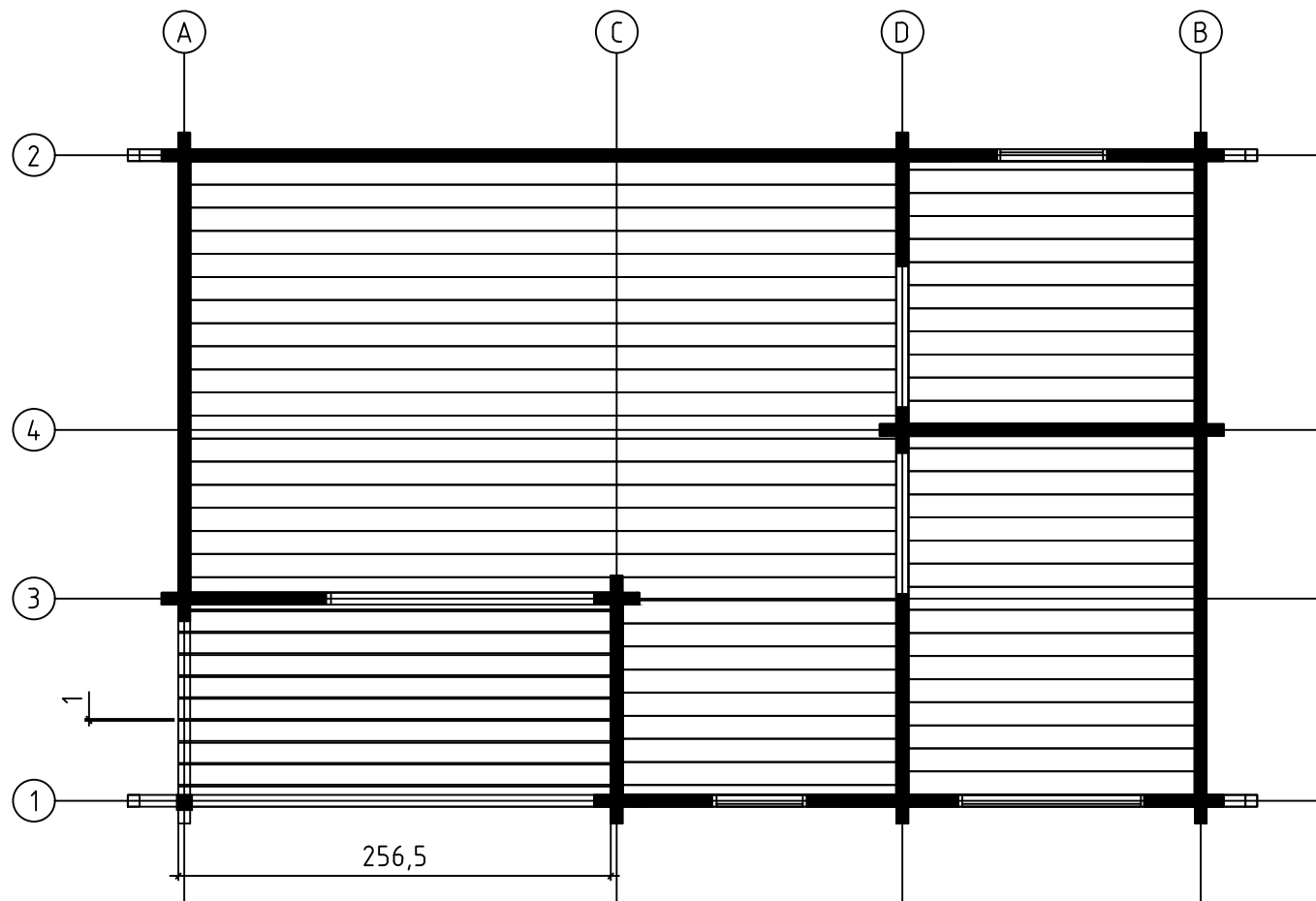

Orkney 4, Art.No.704502
 Rafters plan - Dachsparren - Plan de chevron - Piano di travi - Dak spar constructie
 plattegrond - Sarikaplaan

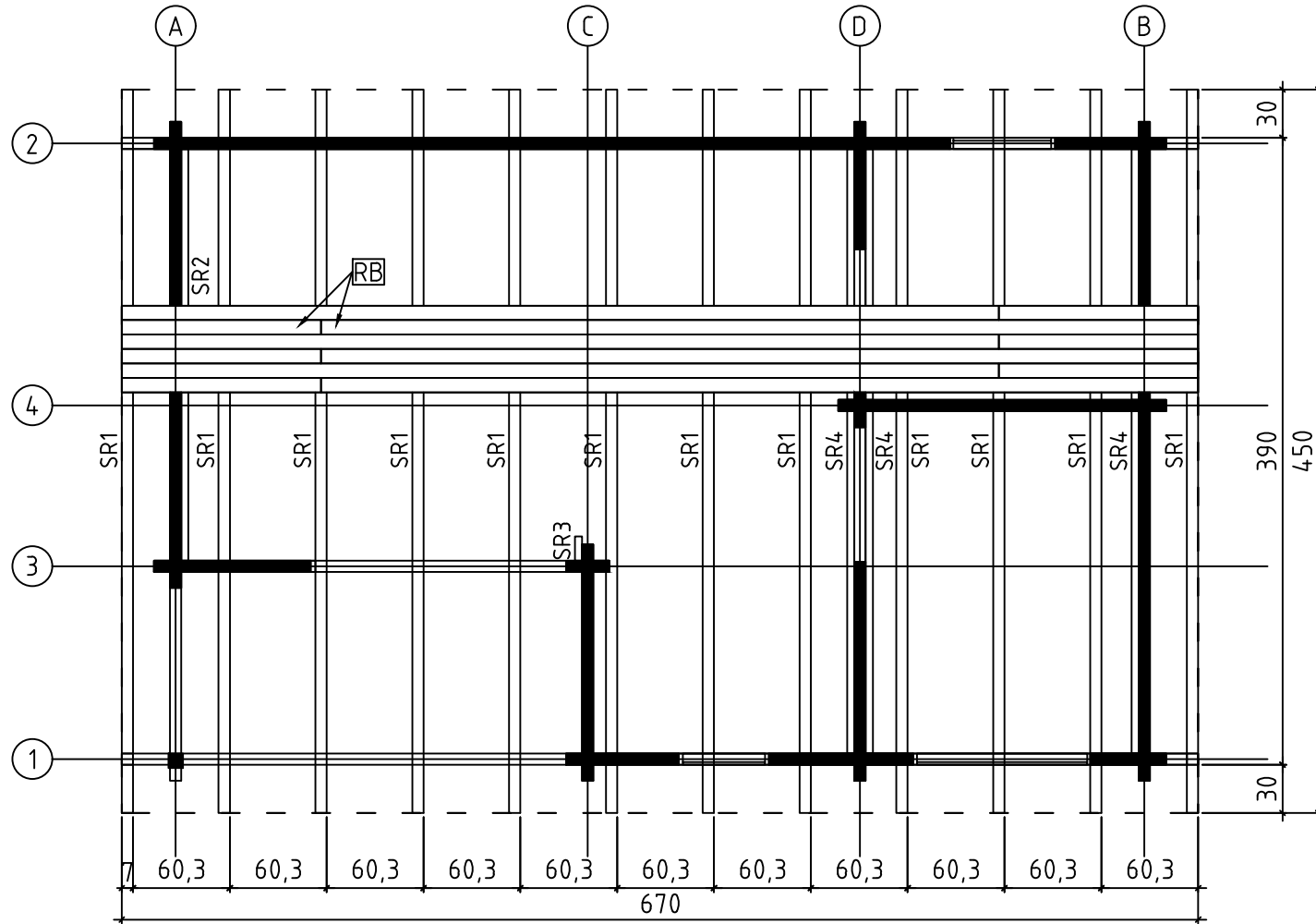

Orkney 4, Art.No.704502

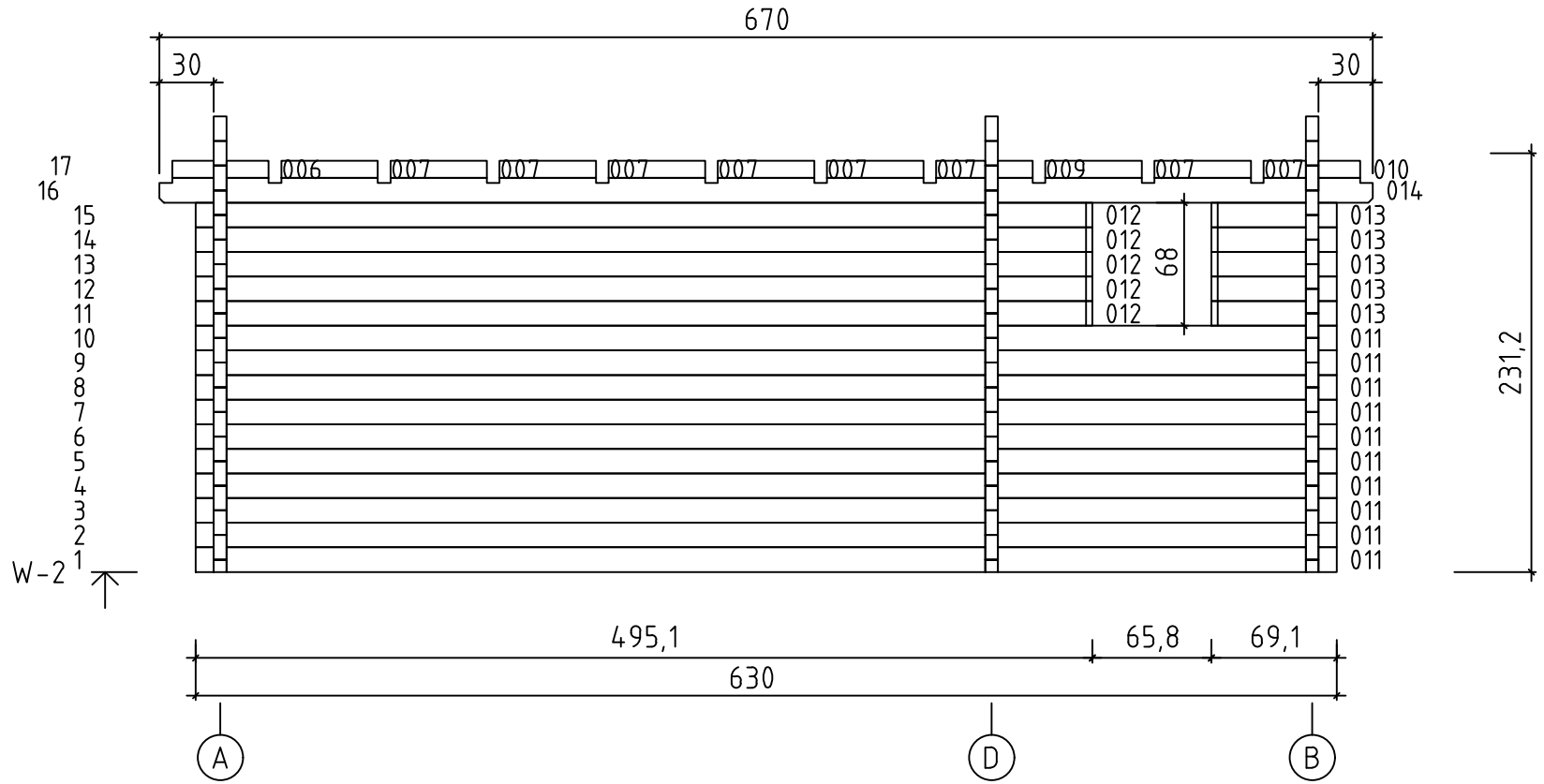



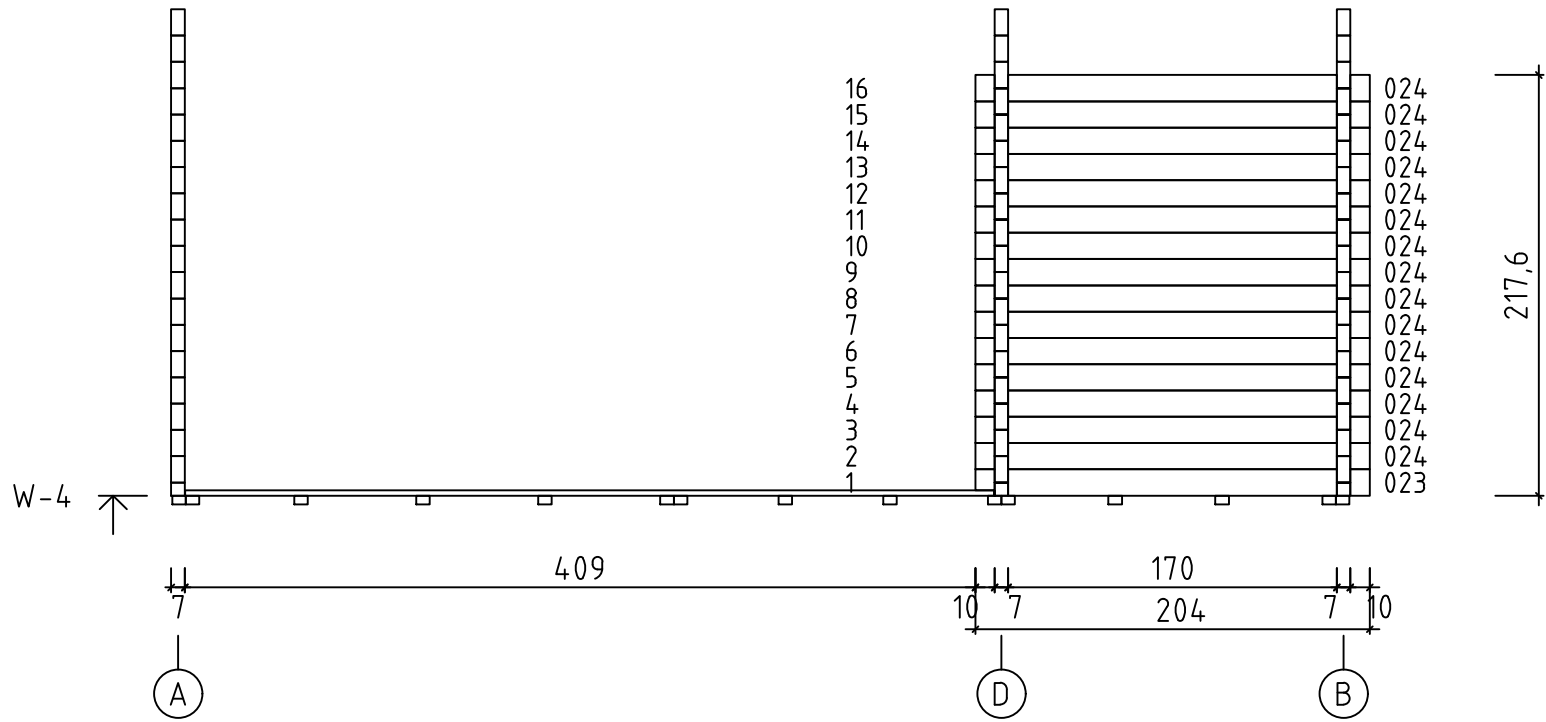

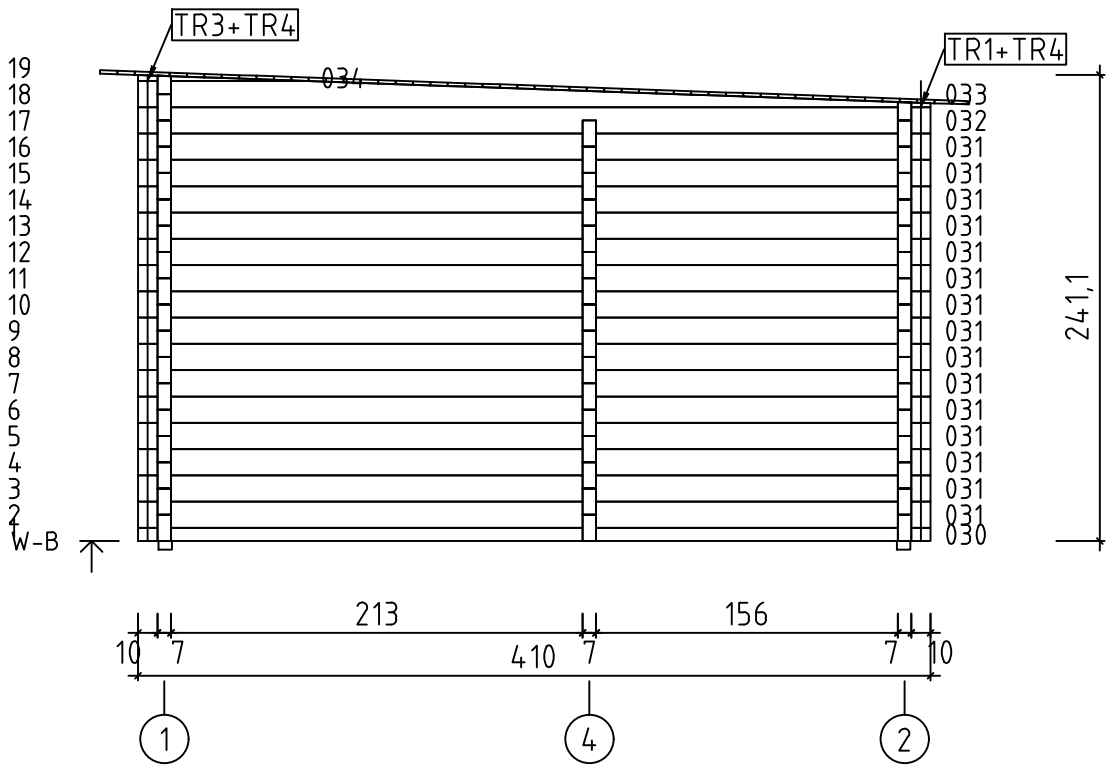
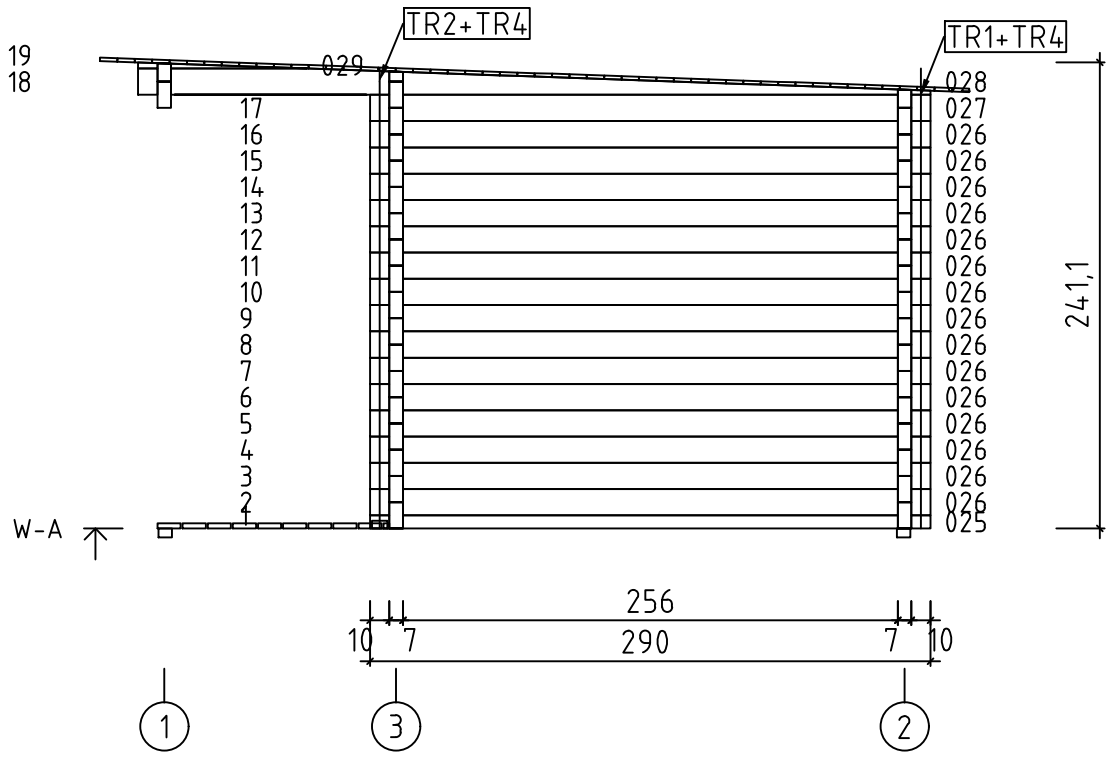

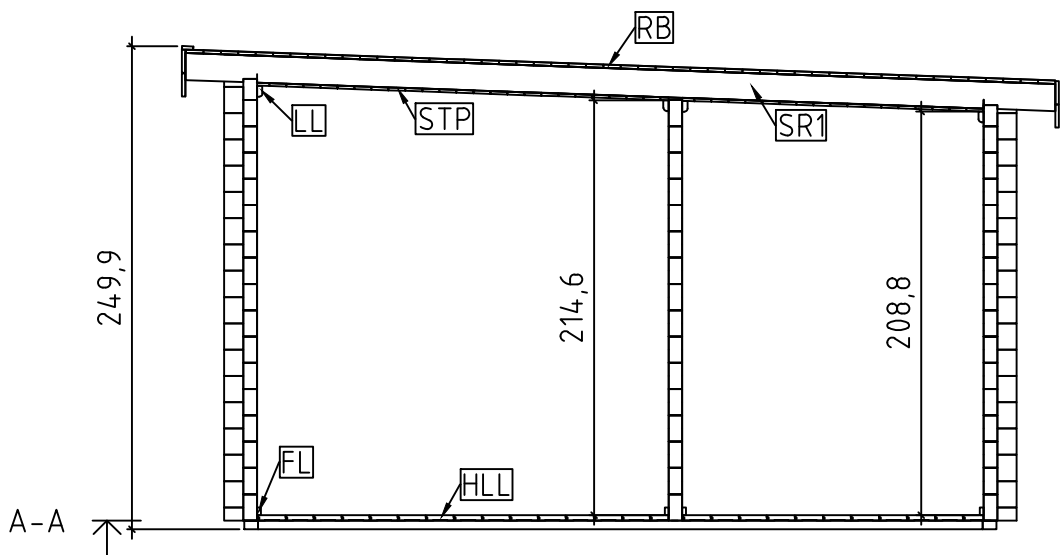
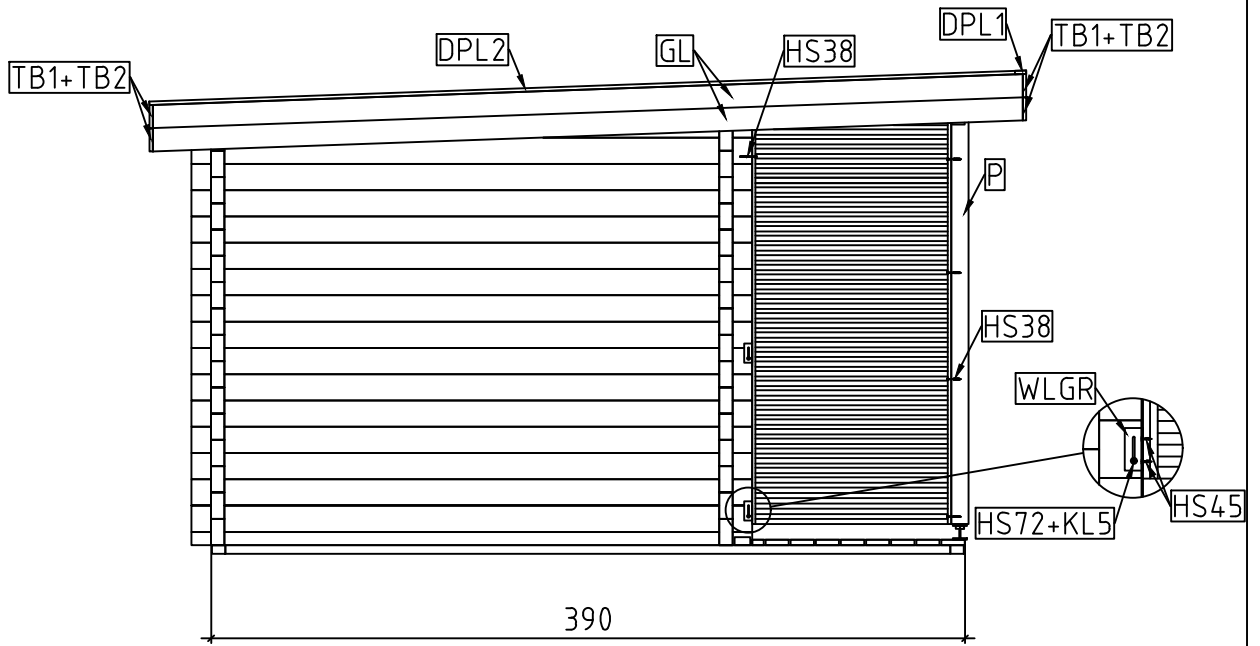
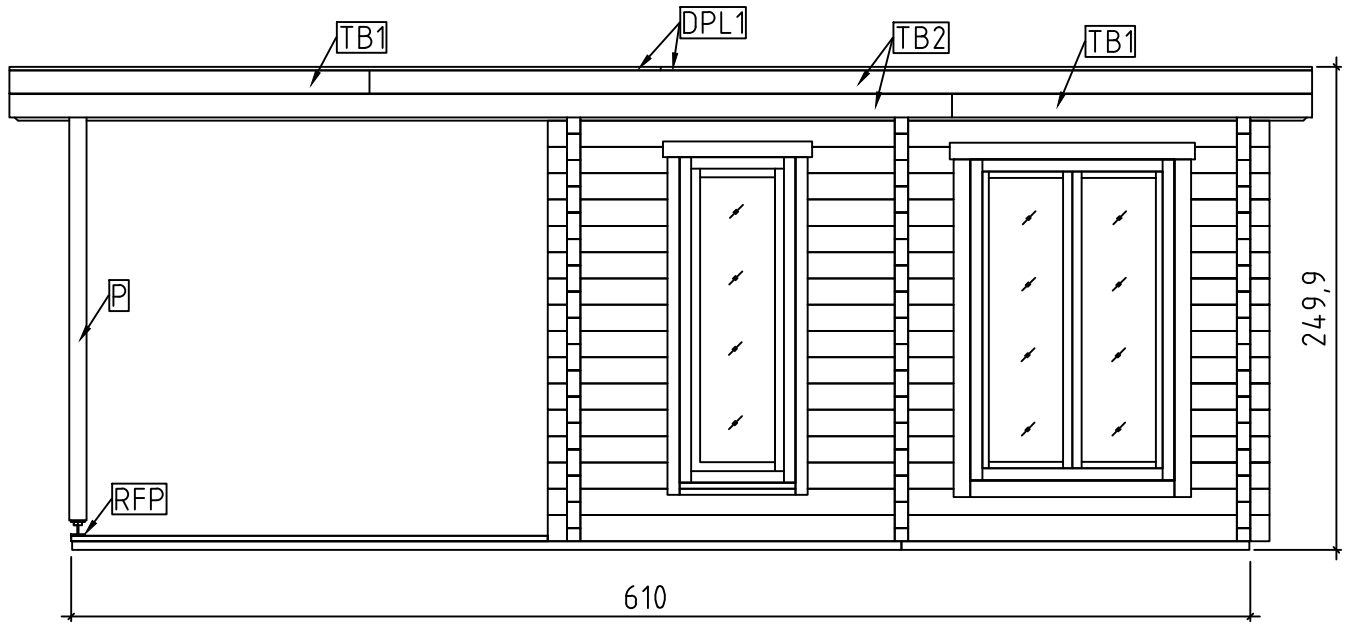

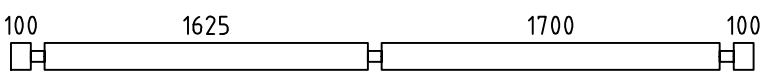
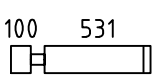
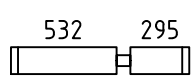
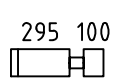
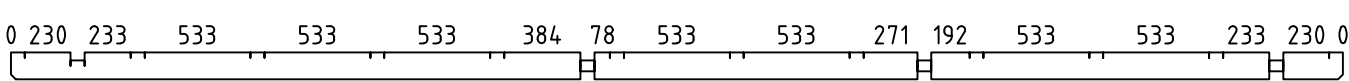
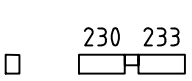
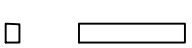
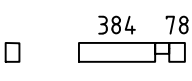
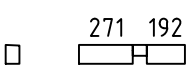
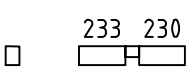
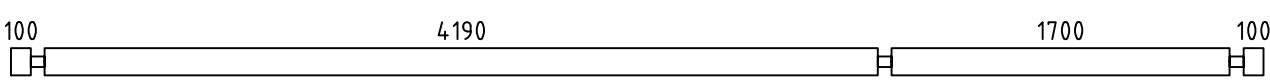
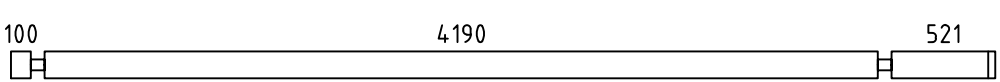
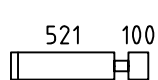
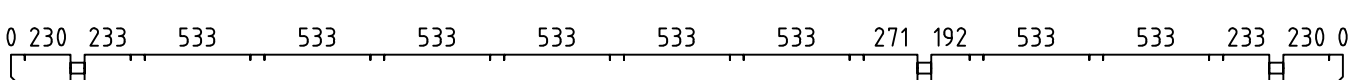
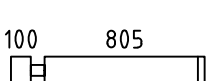

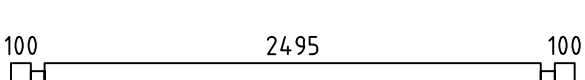
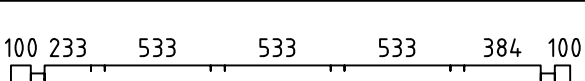
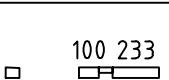
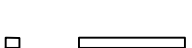
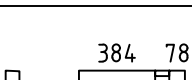
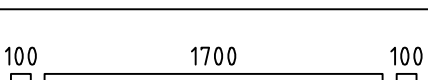
Orkney 4, Art.No.704502

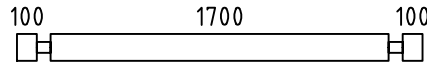
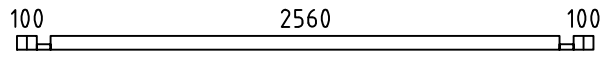
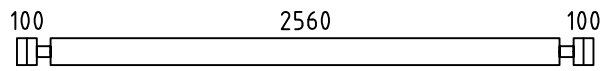
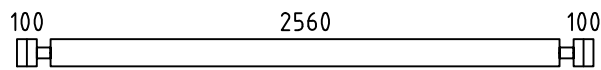
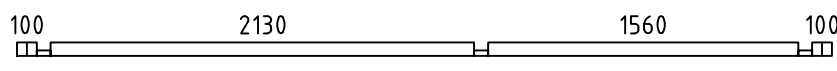
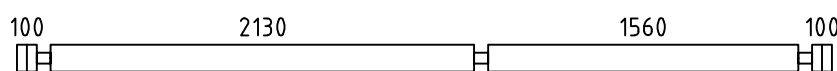
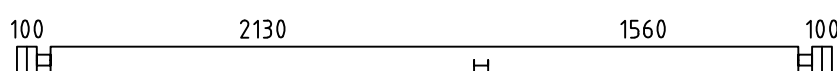
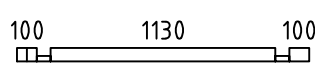
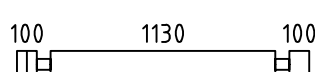
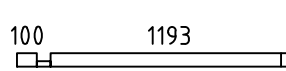

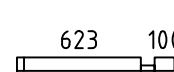
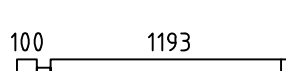

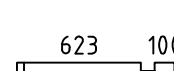

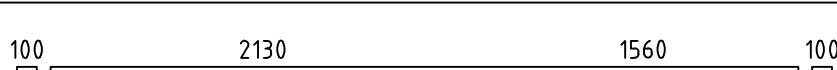

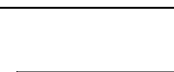
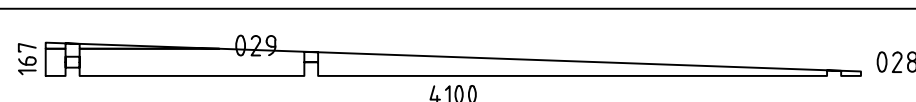
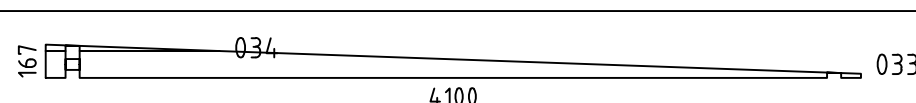
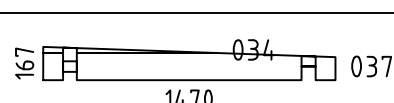
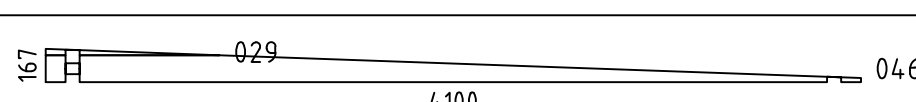



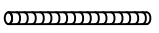
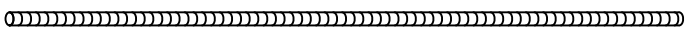
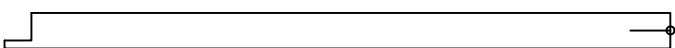

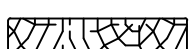



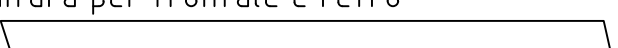
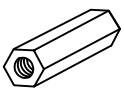

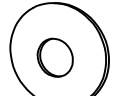

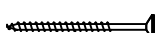

| Pos | Orkney 4, Art.No.704502 Piece list - Stückliste - Liste des pièces - Elementi - Stuklijst - Tükítabel | Q | P (mm) | L (mm) |
|-----|--|----|-----------|-----------|
| 001 |  | 3 | 70x136 | 3735 |
| 002 |  | 13 | 70x136 | 701 |
| 003 |  | 13 | 70x136 | 897 |
| 004 |  | 13 | 70x136 | 465 |
| 005 |  | 1 | 70x136 | 6700 |
| 006 |  | 2 | 70x95 | 533 |
| 007 |  | 15 | 70x95 | 533 |
| 008 |  | 1 | 70x95 | 533 |
| 009 |  | 2 | 70x95 | 533 |
| 010 |  | 2 | 70x95 | 533 |
| 011 |  | 10 | 70x136 | 6300 |
| 012 |  | 5 | 70x136 | 4951 |
| 013 |  | 5 | 70x136 | 691 |
| 014 |  | 1 | 70x136 | 6700 |
| 015 |  | 15 | 70x136 | 975 |
| 016 |  | 1 | 70x136 | 270 |
| 017 |  | 14 | 70x136 | 270 |
| 018 |  | 1 | 70x136 | 2835 |
| 019 |  | 1 | 70x136 | 2835 |
| 020 |  | 1 | 70x53 | 403 |
| 021 |  | 3 | 70x53 | 533 |
| 022 |  | 1 | 70x53 | 533 |
| 023 |  | 1 | 70x136 | 2040 |

| Pos | Orkney 4, Art.No.704502 Piece list - Stückliste - Liste des pièces - Elementi - Stuklijst - Tükítabel | Q | P (mm) | L (mm) |
|------|--|----|-----------|-----------|
| 024 |  | 15 | 70x136 | 2040 |
| 025 |  | 1 | 70x68 | 2900 |
| 026 |  | 15 | 70x136 | 2900 |
| 027 |  | 1 | 70x136 | 2900 |
| 030 |  | 1 | 70x68 | 4100 |
| 031 |  | 15 | 70x136 | 4100 |
| 032 |  | 1 | 70x136 | 4100 |
| 035 |  | 1 | 70x68 | 1470 |
| 036 |  | 16 | 70x136 | 1470 |
| 038 |  | 1 | 70x68 | 1363 |
| 039 |  | 1 | 70x68 | 270 |
| 040 |  | 1 | 70x68 | 793 |
| 041 |  | 14 | 70x136 | 1363 |
| 042 |  | 14 | 70x136 | 270 |
| 043 |  | 14 | 70x136 | 793 |
| 044 |  | 1 | 70x136 | 4100 |
| 045 |  | 1 | 70x136 | 4100 |
| 047 |  | 1 | 70x10 | 1590 |
| 048 |  | 2 | 70x10 | 837 |
| WA-1 |  | 1 | | |
| WB-1 |  | 1 | | |
| WC-1 |  | 1 | | |
| WD-1 |  | 1 | | |

| Pos | Orkney 4, Art.No.704502 Piece list - Stückliste - Liste des pièces - Elementi - Stuklijst - Tükítabel | Q | P (mm) | L (mm) |
|------|---|----|-----------|-----------|
| IAR3 | Foundation - Fundament - Fondation - Fondamenta - Fundering - Immutatud alusraam  | 2 | 70x45 | 4290 |
| IAR1 | Foundation - Fundament - Fondation - Fondamenta - Fundering - Immutatud alusraam  | 14 | 70x45 | 3750 |
| IAR2 | Foundation - Fundament - Fondation - Fondamenta - Fundering - Immutatud alusraam  | 1 | 70x45 | 2775 |
| IAR4 | Foundation - Fundament - Fondation - Fondamenta - Fundering - Immutatud alusraam  | 2 | 70x45 | 1800 |
| IAR5 | Foundation - Fundament - Fondation - Fondamenta - Fundering - Immutatud alusraam  | 3 | 70x45 | 561 |
| SR1 | Rafter - Dachsparren - Chevron - Trave - Dak spar - Sarikas  | 8 | 70x140 | 4508 |
| SR1 | Rafter - Dachsparren - Chevron - Trave - Dak spar - Sarikas  | 4 | 70x140 | 4508 |
| SR4 | Rafter - Dachsparren - Chevron - Trave - Dak spar - Sarikas  | 3 | 45x45 | 3764 |
| SR2 | Rafter - Dachsparren - Chevron - Trave - Dak spar - Sarikas  | 1 | 45x45 | 2563 |
| SR3 | Rafter - Dachsparren - Chevron - Trave - Dak spar - Sarikas  | 1 | 45x45 | 152 |
| STP | Ceiling boards - Deckenbrett - Voliges sous plafond - Tavole per piano soffitto - Dakhout - Laelaud  | 24 | 111x15 | 4186 |
| STP | Ceiling boards - Deckenbrett - Voliges sous plafond - Tavole per piano soffitto - Dakhout - Laelaud  | 35 | 111x15 | 1696 |
| STP | Ceiling boards - Deckenbrett - Voliges sous plafond - Tavole per piano soffitto - Dakhout - Laelaud  | 10 | 111x15 | 1621 |
| HLL | Floor boards - Fussbodenbretter - Lame de plancher - Pavimento - Vloerhout - Põrandalaud  | | 137x28 | 155 m. |
| RB | Roof boards - Dachbretter - Voliges - Perlina per tetto - Dakhout - Katuselaud  | 50 | 90x18 | 5460 |
| RB | Roof boards - Dachbretter - Voliges - Perlina per tetto - Dakhout - Katuselaud  | 50 | 90x18 | 1240 |
| | Terrace boards - Terrassenbretter - Plancher de terrasse - Piattaforme terrazzo - Terrasvloer - Terrassilaud  | 10 | 120x28 | 2565 |
| FL | Floor fillet - Fussbodenleiste - Corniere de finition du plancher - Finitura per pavimento (battisco pa) - Vloerafwerkljst - Põrandaliist  | | 15x40 | 31 m. |
| LL | Ceiling fillet - Deckeleiste - Profil de finition sous plafond - Massello per soffitto - Dak afdekljst - Laeliist  | | 15x40 | 31 m. |
| DPL1 | Roofing felt fillet - Dachpappenleiste - Baguette de fixation du feutre bitumeux - Asse per fissaggio guaina bituminosa - Afdekljst asfaltpapier - Katussepiliist  | 2 | 18x58 | 3369 |
| DPL2 | Roofing felt fillet - Dachpappenleiste - Baguette de fixation du feutre bitumeux - Asse per fissaggio guaina bituminosa - Afdekljst asfaltpapier - Katussepiliist  | 2 | 18x58 | 4481 |
| TR1 | Treaded rod m12 - Gewindestange m12 - Tige filetée m12 - Barra filettata passo m12 - Draadstang 12m - Keermelatt  | 2 | | 300 |
| TR2 | Treaded rod m12 - Gewindestange m12 - Tige filetée m12 - Barra filettata passo m12 - Draadstang 12m - Keermelatt  | 1 | | 355 |

| Pos | Orkney 4, Art.No.704502 Piece list - Stückliste - Liste des pièces - Elementi - Stuklijst - Tükítabel | Q | P (mm) | L (mm) |
|------|---|-----|-----------|-----------|
| TR3 | Treaded rod m12 - Gewindestange m12 - Tige filetée m12 - Barra filettata passo m12 - Draadstang 12m - Keermelatt  | 2 | | 410 |
| TR4 | Treaded rod m12 - Gewindestange m12 - Tige filetée m12 - Barra filettata passo m12 - Draadstang 12m - Keermelatt  | 5 | | 2000 |
| P | Post - Pfosten - Poteau - Piede registrabile - Stijl - Post  | 1 | 90x90 | 2136 |
| TB1 | Fascia board - Traufbrett - Bandeau de toit - Finitura lati tetto - Gevellijst - Räästalaud  | 4 | 18x120 | 1863 |
| TB2 | Fascia board - Traufbrett - Bandeau de toit - Finitura lati tetto - Gevellijst - Räästalaud  | 4 | 18x120 | 4876 |
| TBE6 | Fixing fillet - Fixierungsleiste - Profil de fixation - Massello di fissaggio - Bevestiging lijstwerk - Tenderliist  | 2 | 28x34 | 650 |
| TBE6 | Fixing fillet - Fixierungsleiste - Profil de fixation - Massello di fissaggio - Bevestiging lijstwerk - Tenderliist  | 4 | 28x34 | 1729 |
| TBE6 | Fixing fillet - Fixierungsleiste - Profil de fixation - Massello di fissaggio - Bevestiging lijstwerk - Tenderliist  | 4 | 28x34 | 1894 |
| TBE6 | Fixing fillet - Fixierungsleiste - Profil de fixation - Massello di fissaggio - Bevestiging lijstwerk - Tenderliist  | 2 | 28x34 | 1990 |
| GL | Gable moulding - Giebelleiste - Planche de rive - Finitura per frontale e retro del tetto - Gevellijst - Viilulaud  | 4 | 18x120 | 4507 |
| KL4 | Lengthening bolt for treaded rod - Verlängerungsmutter für gewindestange - Manchon de raccordement de tige filetée - Bullone per barra filettata passo - Extensie moer voor draadstang - Jätikumutter keermelatile  | 5 | | |
| KL1 | Drive nut treaded rod - Einshlagmutter für gewindestange - Écrou a frapper pour tige filitée - Dado guida per barra filettata - Aandrijfmoer / aanslagmoer voor draadstang - Löökmutter keermelatile  | 5 | | |
| KL2 | Nut for treaded rod - Mutter für gewindestange - Écrou pour tige filetée - Dado per barra filettata - Moer voor draadstang - Mutter keermelatile  | 5 | | |
| KL3 | Plain washer treaded rod - Unterlegscheibe für gewindestange - Rondelle plate pour tige filetée - Rondella per barra filettata - Sluitring voor draadeind - Seib keermelatile  | 5 | | |
| HS25 | Screw for floor - Schrauben für fussbodenbretter - Vis pour plancher - Viti per le perline del pavimento - Schroef voor vloerhout - Kruvi põrandale  | 380 | 3.5x50 | |
| HS32 | Screw for fascia boards - Schrauben für traufbretter - Vis pour fixation bandeau de toit - Viti x striscia del tetto - Schroef voor gevellijst - Kruvi räästalauale  | 104 | 3.5x50 | |
| HS84 | Screw for fixing fillet of door and window - Schrauben für fixierungsleiste - Vis pour profil vertical de fixation pour ouvertures des fenetres et portes - Viti per massello di fissaggio - Schroeven voor bevestiging van deur en raam lijsten - Kruvi tenderliistudele  | 56 | 3.5x50 | |
| HS16 | Screw for gable moulding - Schrauben für giebelleiste - Vis pour fixation planche de rive - Vite per fissare finiture davanti e dietro del tetto - Schroef voor gevellijst - Kruvi viilulauale  | 44 | 3.5x50 | |
| HS38 | Screw for fixing terrace railing - Schraube für terrasse - Vis de fixation de garde-corps de terrasse - Vite per fissaggio della ringhiera al terrazzo - Schroef voor terras - Kruvi piirdeaia kinnituseks  | 5 | 4.5x80 | |
| HS37 | Screw for post - Schrauben für pfosten - Vis de fixation des poteaux - Viti per inviare - Schroef voor stijlen - Kruvi postile  | 2 | 4.5x80 | |
| HS45 | Screw for sliding wall tie - Schieberegler für wand - Sabot métallique pour fixation mur - Vite per fissare scorrimento a c su slitta fissata alla parete - Schuifdeur instellingen wand - Kruvi seinaliugurile  | 8 | 4x20 | |
| NFD | Screw for roofing felt fillet - Schrauben für dachpappenleiste - Vis pour fixation baguette de fixation feutre bitumeux - Vite per massellino del feltro del tetto - Schroef voor asfaltpaier afdekljst - Kruvi katusepapiliistule  | 36 | 4x40 | |
| HS40 | Screw for 1. wall beam - Schraube für 1. bohlenreihe - Vis de fixations 1ere rangée de madriers avec poutrelles de fondations - Vite fissaggio alle fondamenta - Schroef voor 1 wandbalk - Kruvi poollauale  | 16 | 5x120 | |

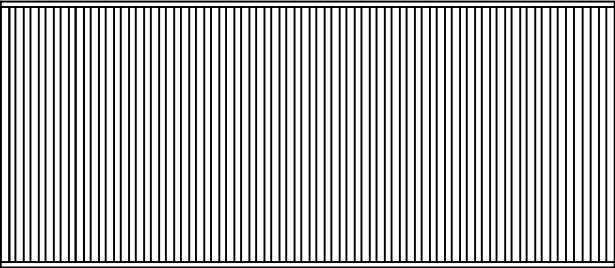
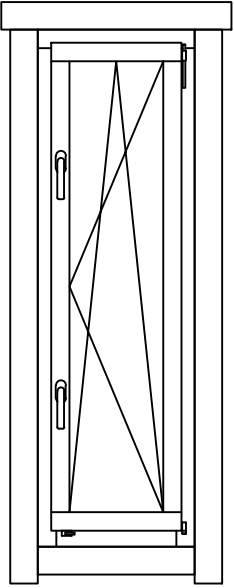
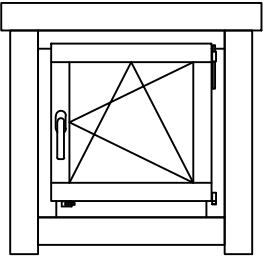
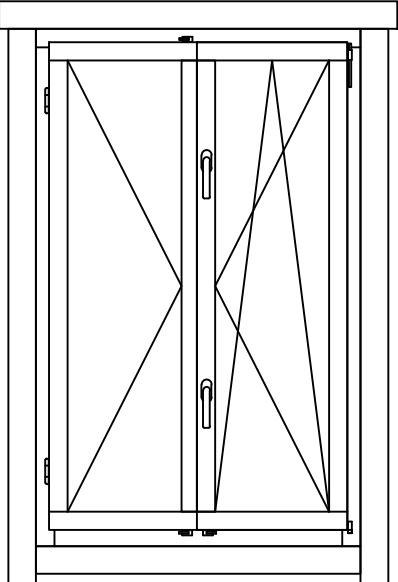
| Pos | Orkney 4, Art.No.704502 Piece list - Stückliste - Liste des pièces - Elementi - Stuklijst - Tükítabel | Q | P (mm) | L (mm) |
|-----|---|---|----------------------|-----------|
| | Terrace railing - Terrassenzaun - Garde-corps de terrasse - Ringhiera per terrazza - Terras rails (leuning) - Piirdeaed kõrgusega  | 1 | | 2136 |
| | Window - Fenster - Fenetre - Finestra - Raam - Aken  | 1 | 552x1729 2+ A.0P.b | |
| | Window - Fenster - Fenetre - Finestra - Raam - Aken  | 1 | 650x650 2+ A.0P.c | |
| | Window - Fenster - Fenetre - Finestra - Raam - Aken  | 1 | 1100x1729 2+ TA.0P.b | |
| | | | | |
| | | | | |
| | | | | |

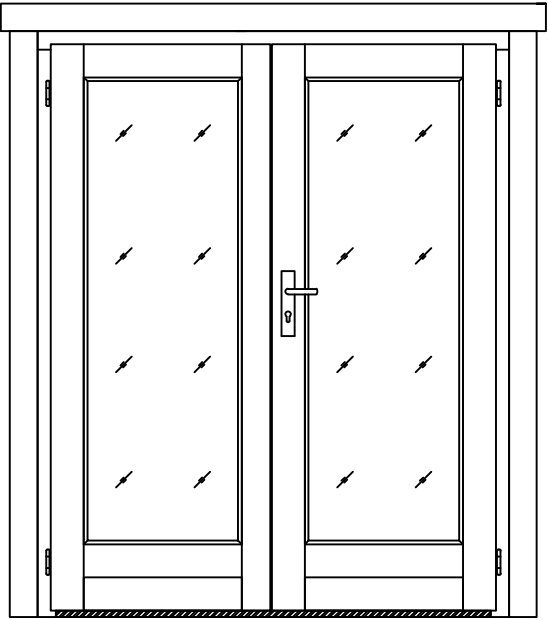
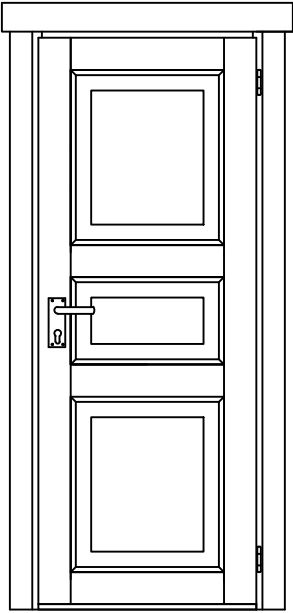
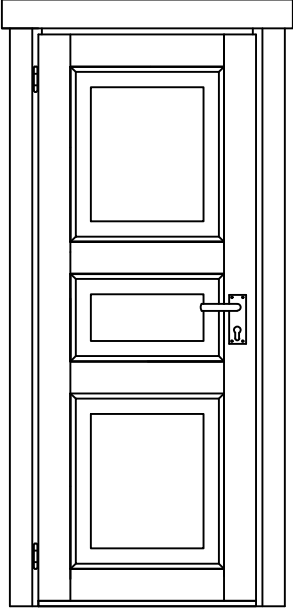
| Pos | Orkney 4, Art.No.704502 Piece list - Stückliste - Liste des pièces - Elementi - Stuklijst - Tükitabel | Q | P (mm) | L (mm) |
|-----|---|---|-----------|-----------|
| | Door - Tür - Porte - Porte - Deur - Uks <div style="text-align: right;">1580x2000 2+ TU.10P.b</div>  | 1 | | |
| | Door - Tür - Porte - Porte - Deur - Uks <div style="text-align: right;">827x2000 U.3TP.b</div>  | 1 | | |
| | Door - Tür - Porte - Porte - Deur - Uks <div style="text-align: right;">827x2000 U.3TV.b</div>  | 1 | | |
| | | | | |
| | | | | |
| | | | | |
| | | | | |
| | | | | |

