

*Caroline*  
Art. Nr. 4014899  
1/13

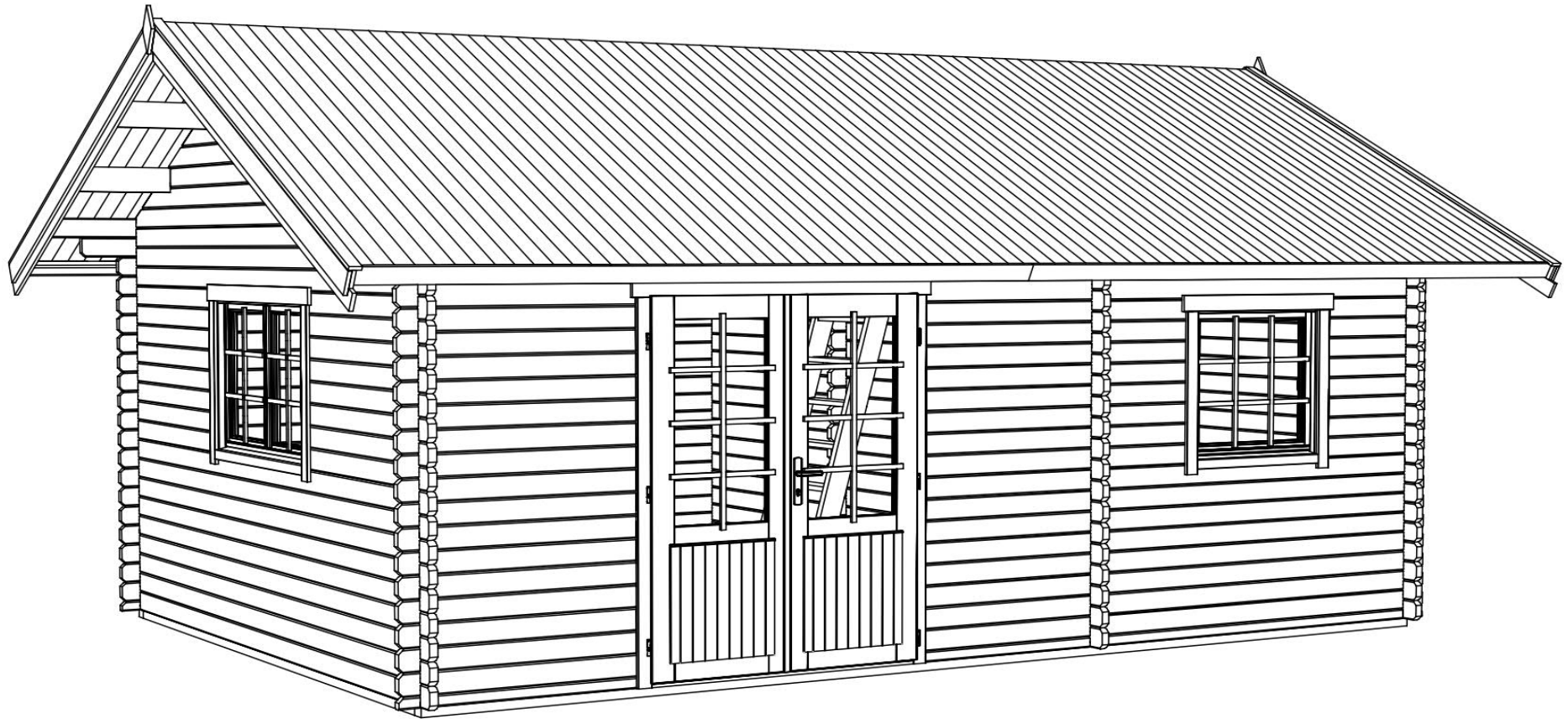

Art. Nr. 4014899

Groundplan - Grundplan - Plan de  
masse - Planimetria - Plattegrond -  
Põhiplan

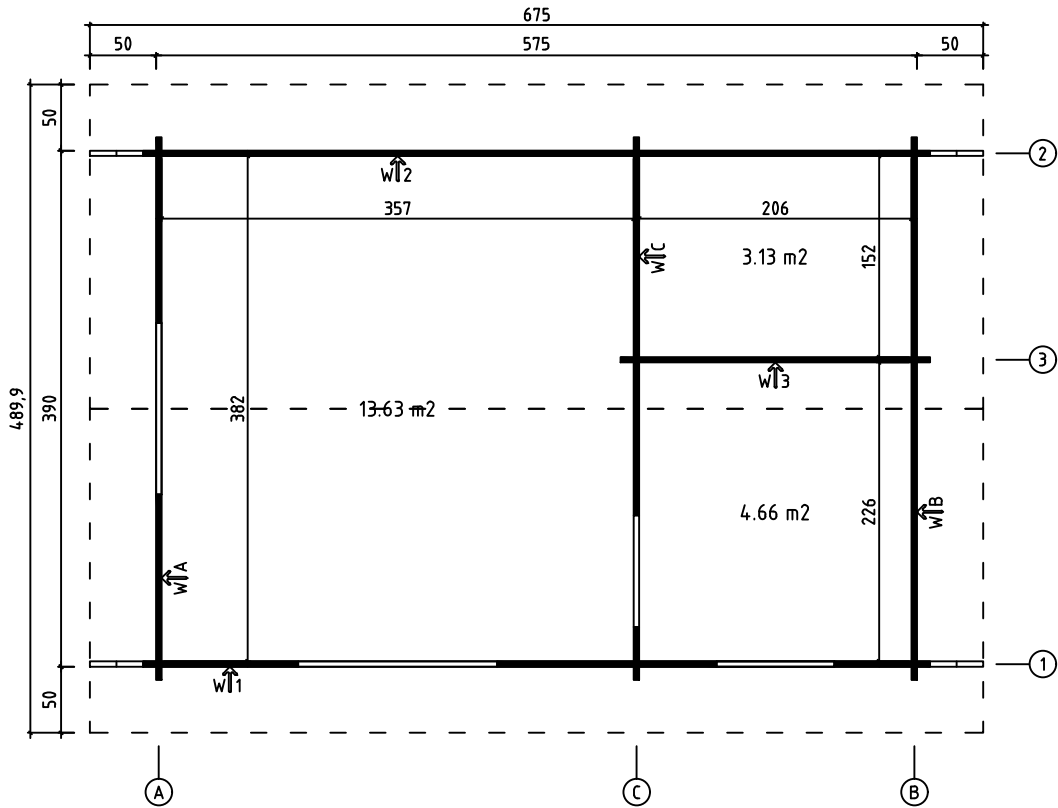

First floor plan - Grundplan für erste stock - Plan du premier etage

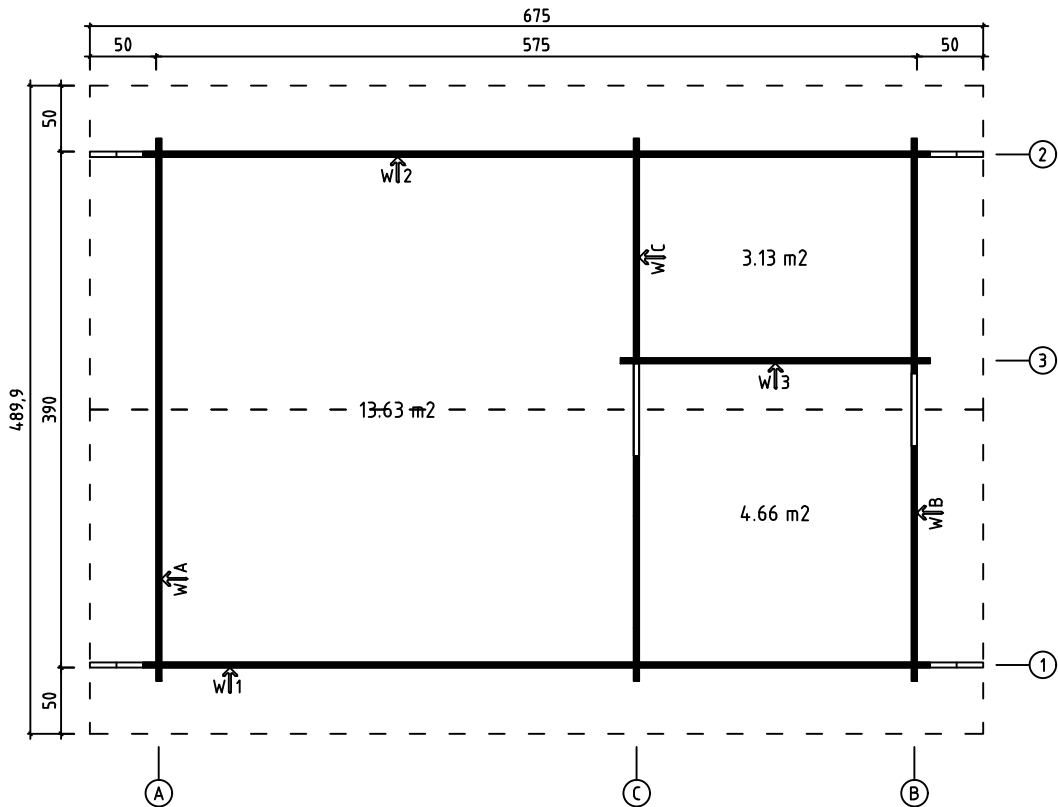

Art. Nr. 4014899

Foundation - Fundament - Fondation  
- Fundamenta - Fundering -  
Immutatud alusraam

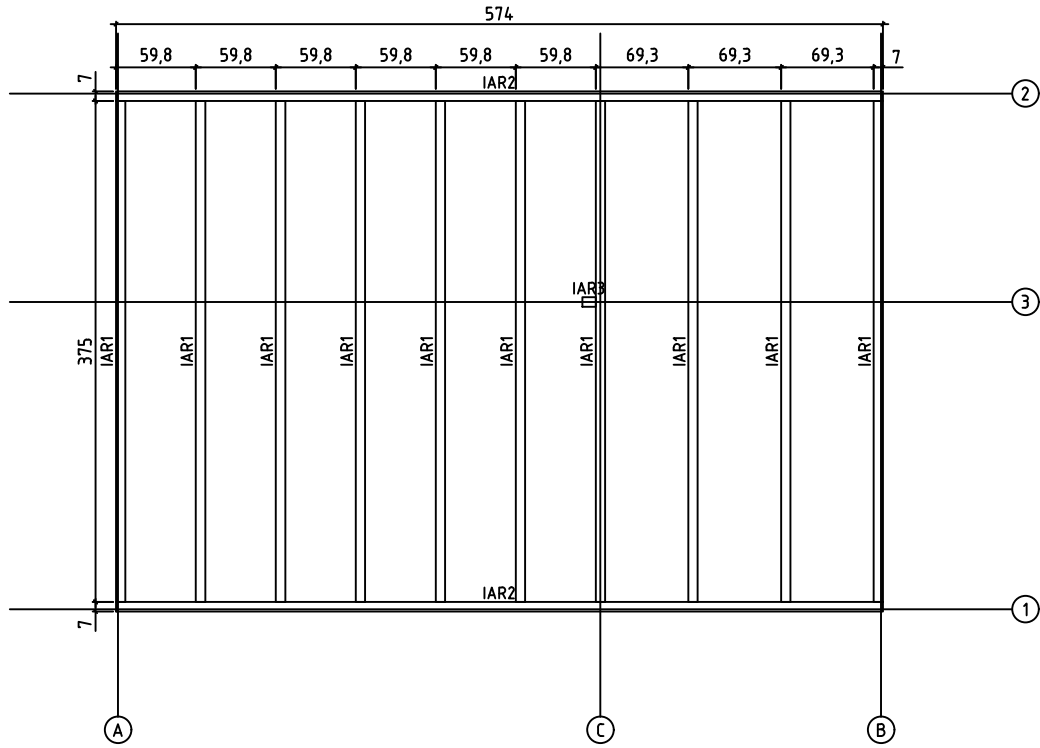

Mezzanine floor joists - Halbgeschoss balken -  
Solives de plancher mezzanine - Travi del pavimento mezzanino -  
Plaatduim scharnier - Laetlad

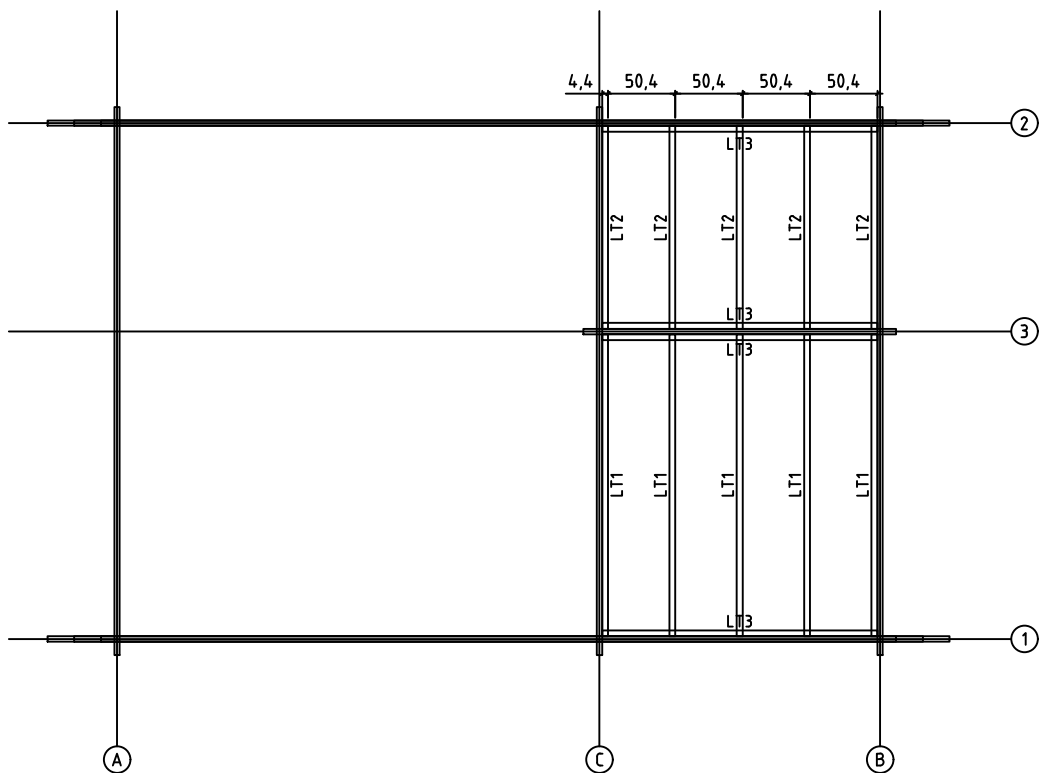

Art. Nr. 4014899

Floor boards - Fussbodenbretter -  
Plan pose plancher - Pavimento -  
Vloerhout - Põrandalaudis

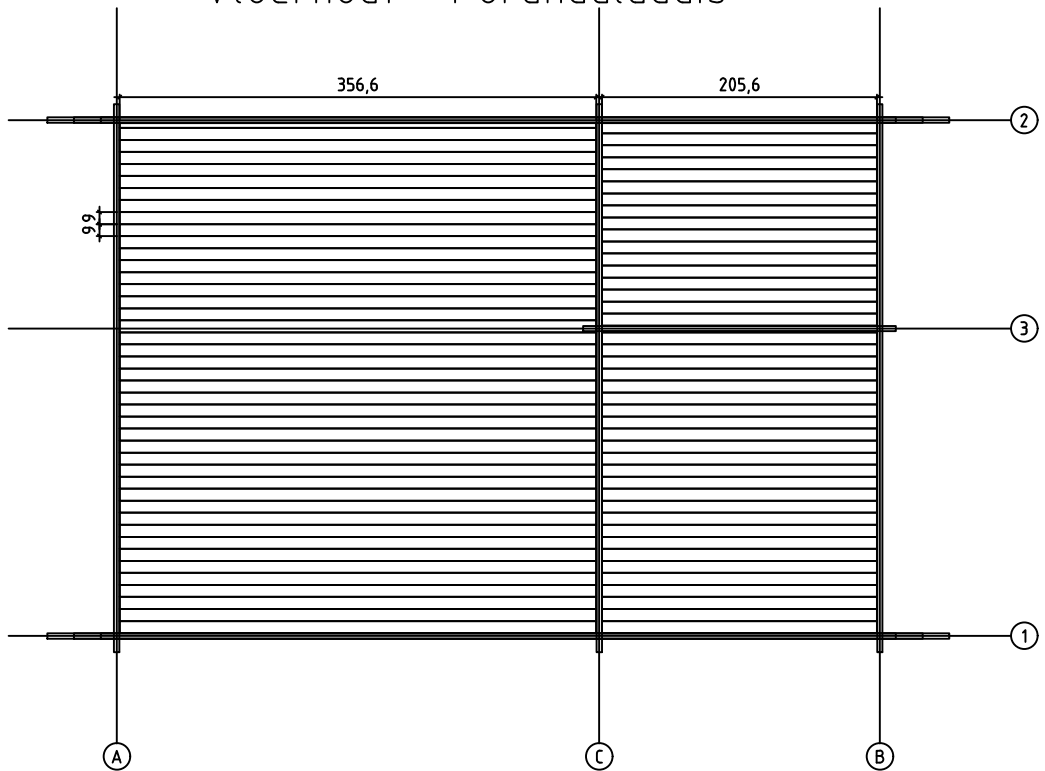

First floor floorboards - Fussbodenbretter für  
erste stock - Plan pose plancher du premier etage

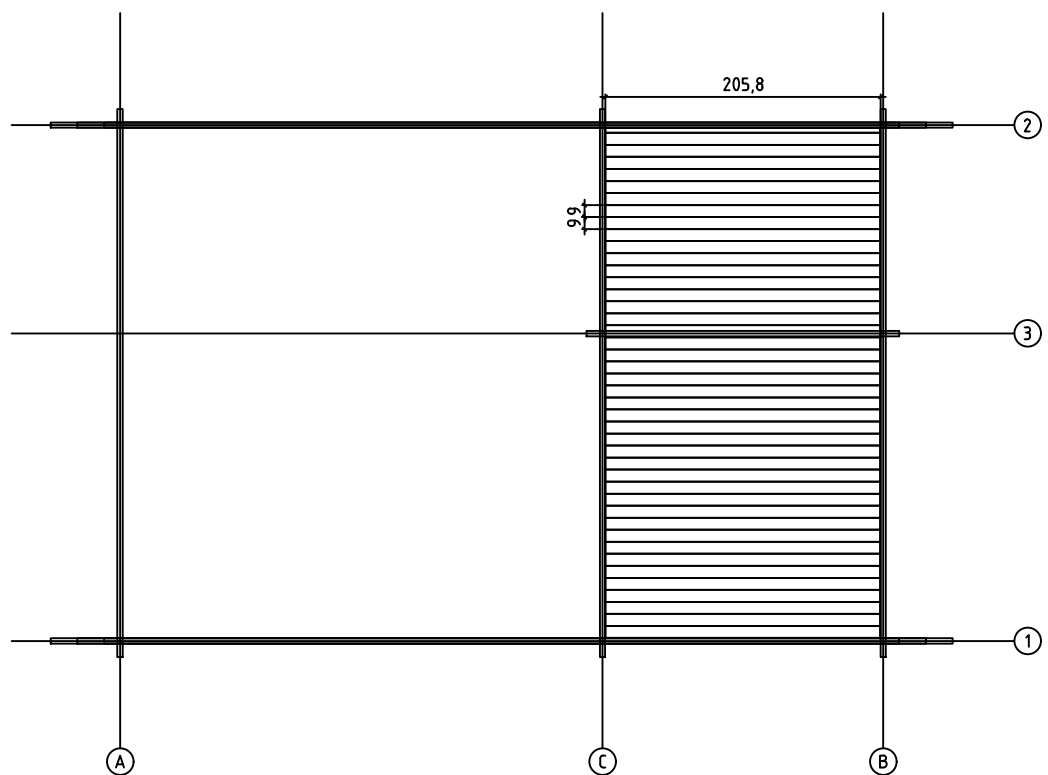







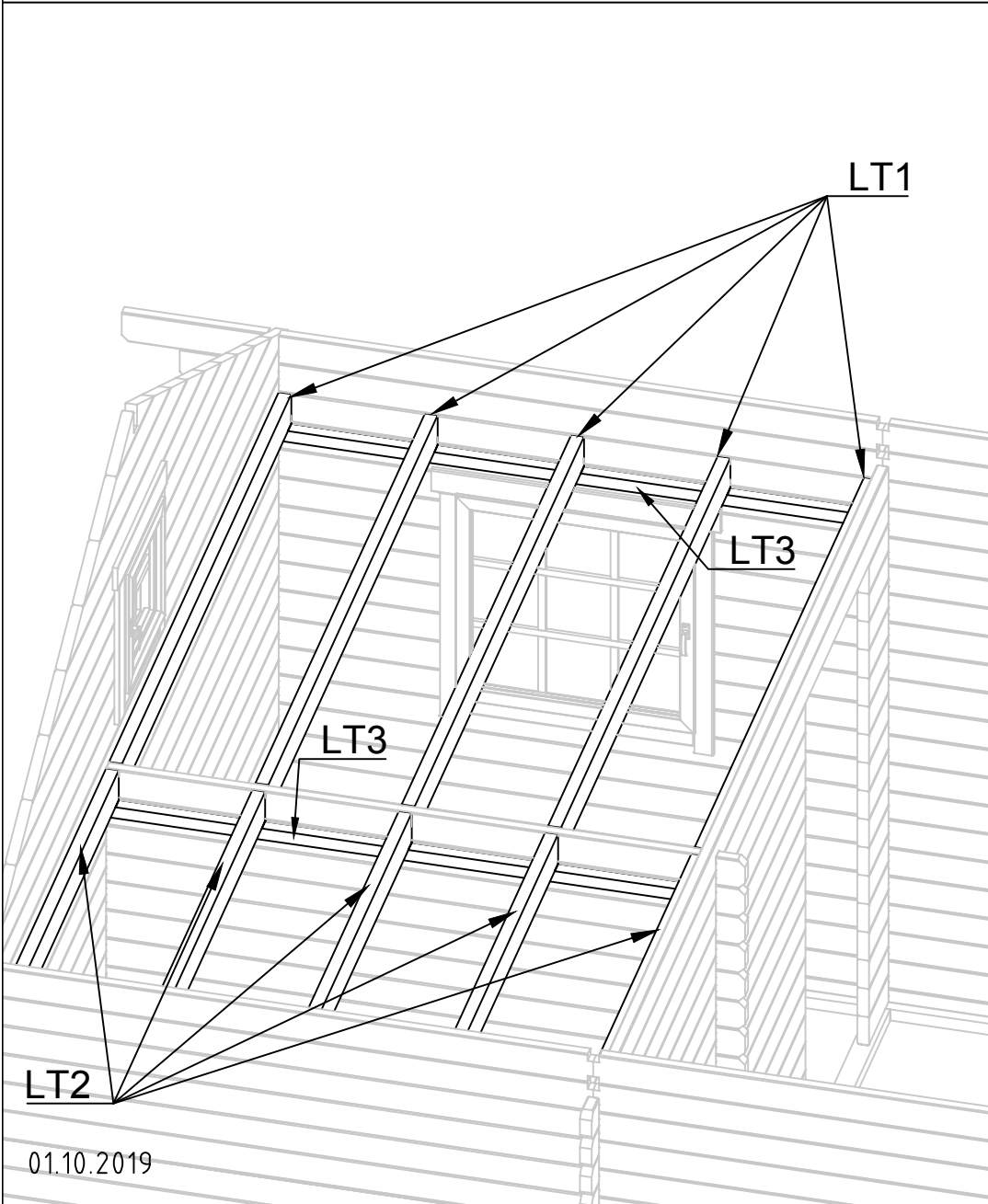



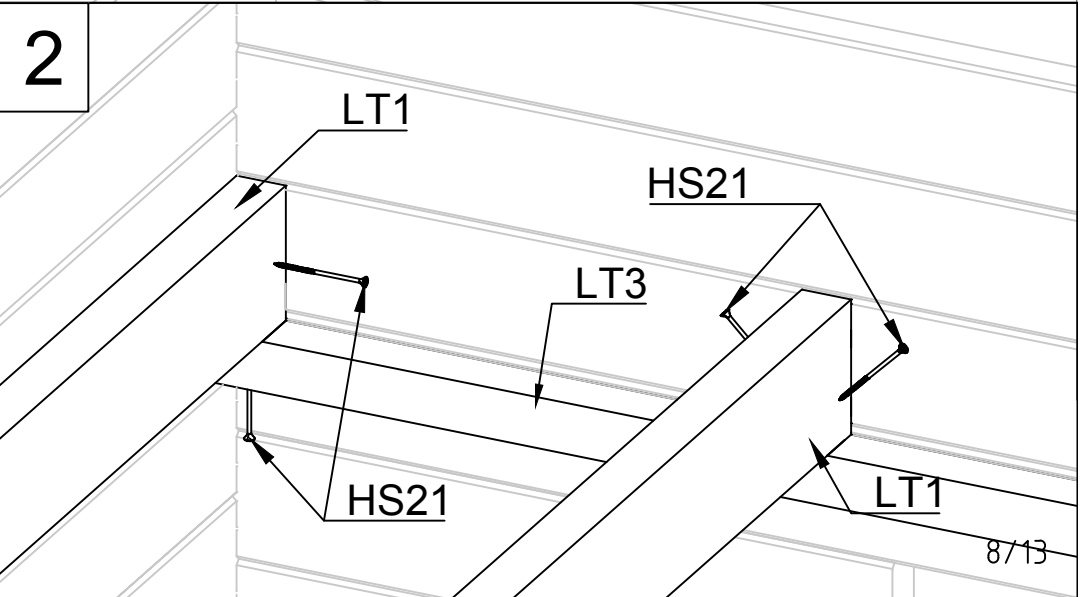
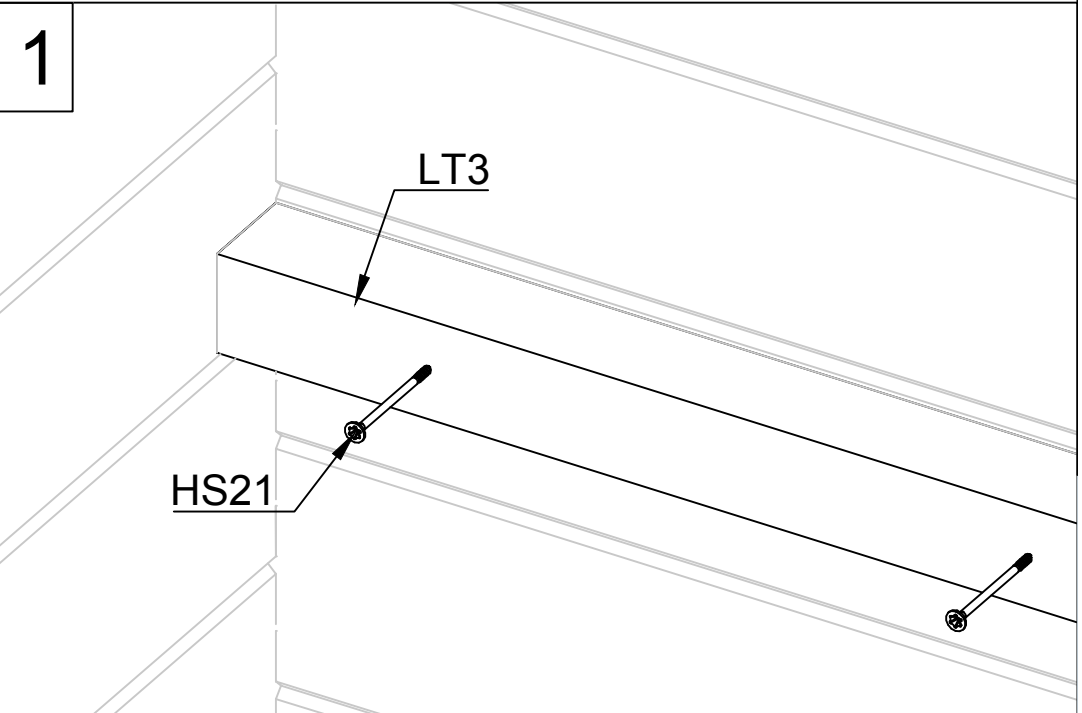



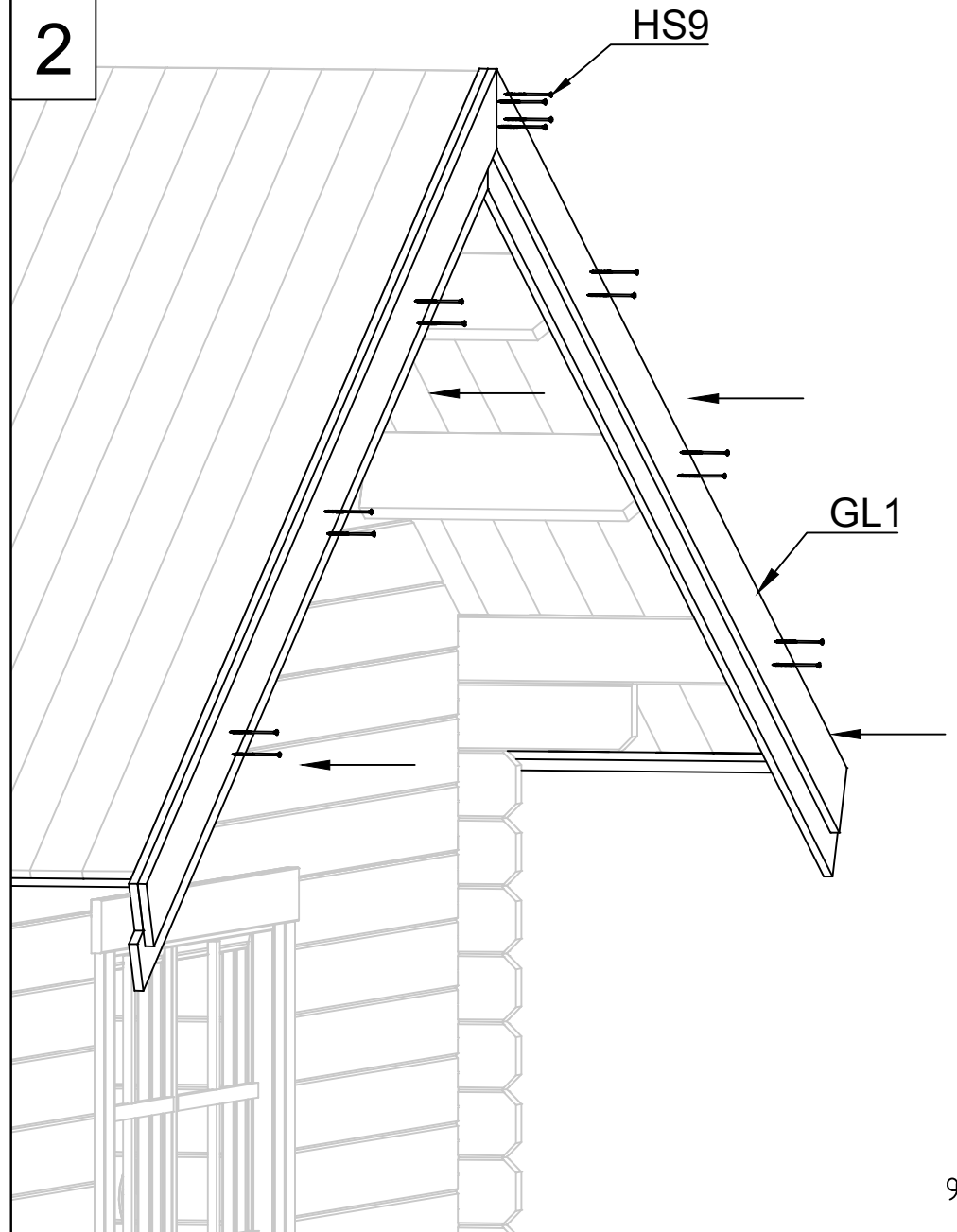
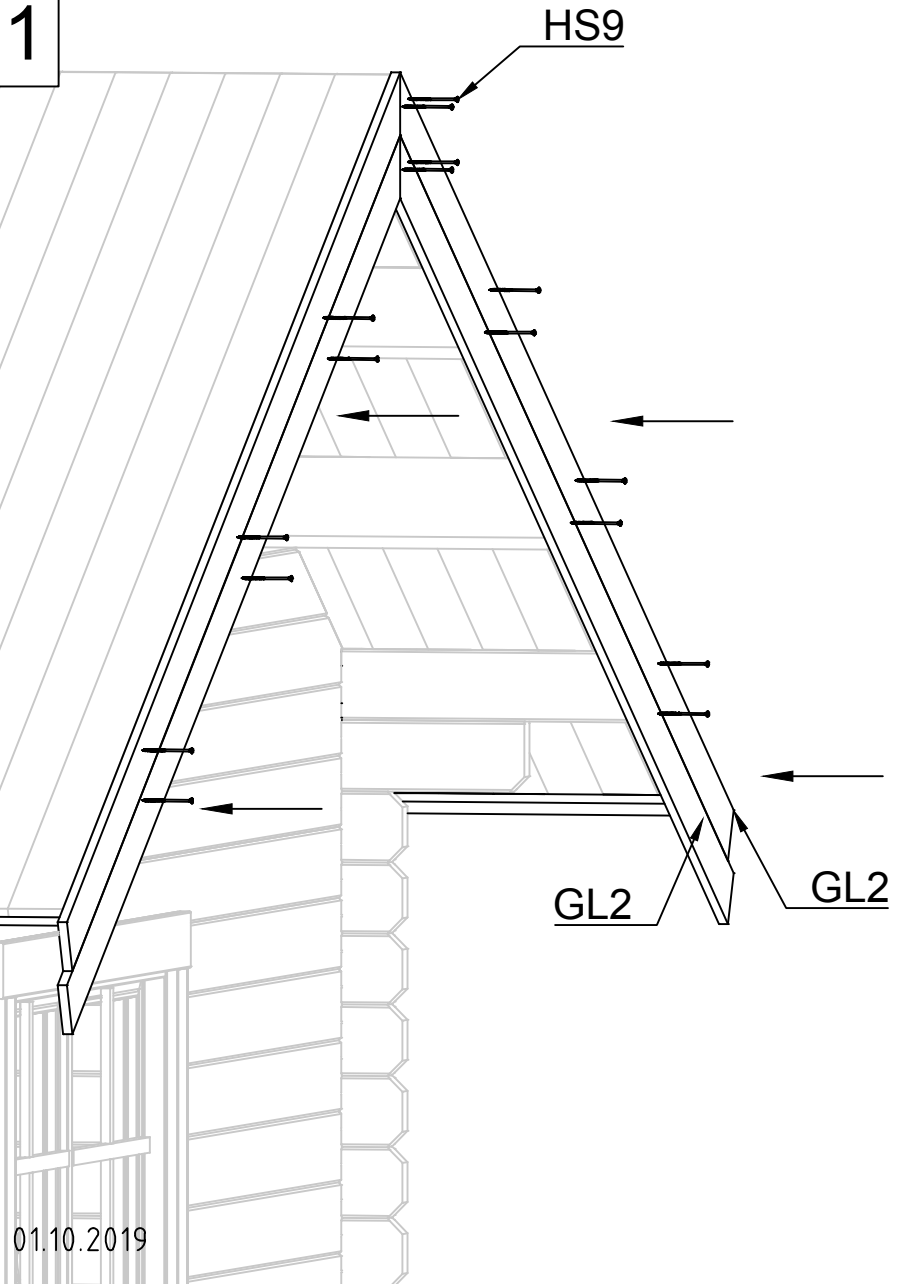

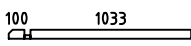
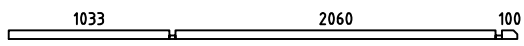
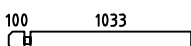
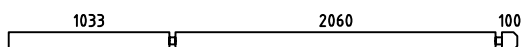
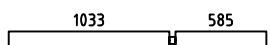
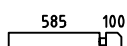
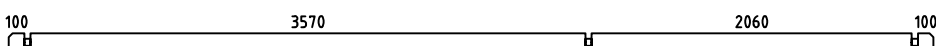
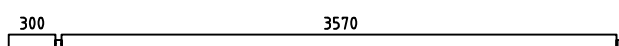
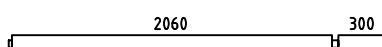
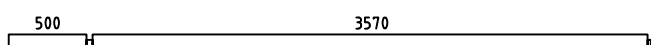
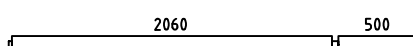

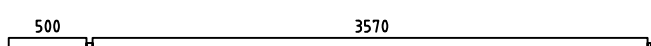
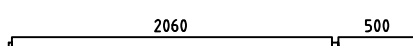
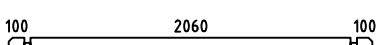
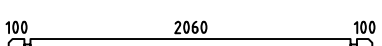
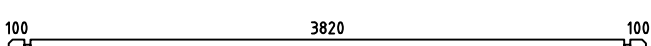
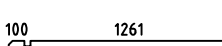
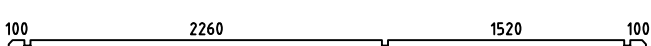
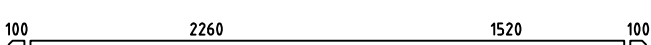

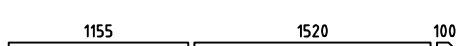
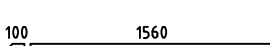

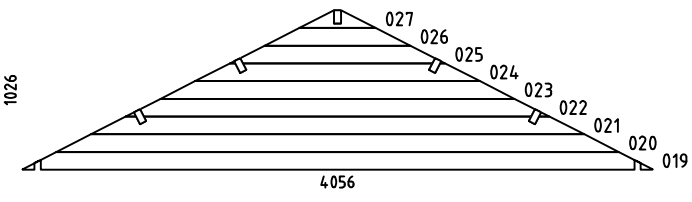
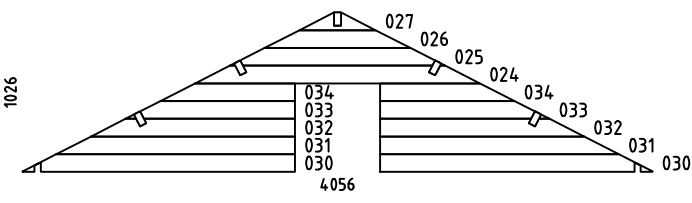
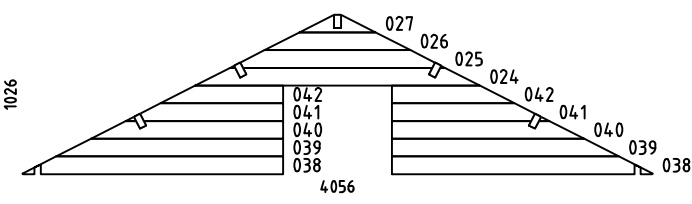
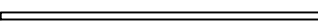
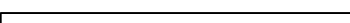
01.10.2019

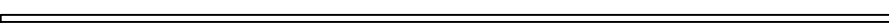
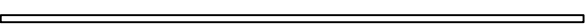

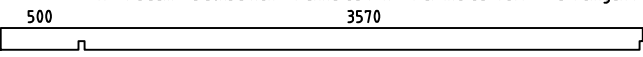
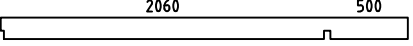

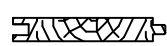





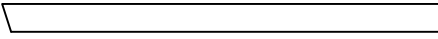

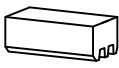

Pos	01.10.2019 Piece list - Stückliste - Liste des pièces - Elementi - Stuklijst - Tükítabel Art. Nr. 4014899 10/13	Q	P (mm)	L (mm)
001		1	40x57	1173
002		1	40x57	3273
003		17	40x114	1173
004		9	40x114	3273
005		8	40x114	1658
006		8	40x114	725
007		19	40x114	5950
008		2	40x114	3930
009		2	40x114	2420
010		1	40x120	4130
011		1	40x120	2620
012		1	40x57	5950
013		1	40x120	4130
014		1	40x120	2620
015		1	40x57	2340
016		18	40x114	2340
017		13	40x114	4100
018		16	40x114	1401
028		19	40x114	4100
029		2	40x114	4100
035		17	40x114	400
036		17	40x114	2855
037		2	40x114	1700

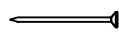
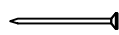
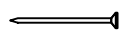
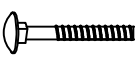
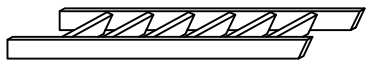
Pos	01.10.2019 Piece list - Stückliste - Liste des pièces - Elementi - Stuklijst - Tükitalabel Art. Nr. 4014899 11/13	Q	P (mm)	L (mm)
WA-1		1		
WB-1		1		
WC-1		1		
LT3	Mezzanine floor joists - Halbgeschoss balken - Solives de plancher mezzanine - Travi del pavimento mezzanino - Balk - Laetalad 	4	45x45	2060
LT1	Mezzanine floor joists - Halbgeschoss balken - Solives de plancher mezzanine - Travi del pavimento mezzanino - Balk - Laetalad 	5	44x120	2260
LT2	Mezzanine floor joists - Halbgeschoss balken - Solives de plancher mezzanine - Travi del pavimento mezzanino - Balk - Laetalad 	5	44x120	1520
IAR2	Foundation - Fundament - Fondation - Fondamenta - Fundering - Immutatud alusraam 	2	70x45	5740
IAR1	Foundation - Fundament - Fondation - Fondamenta - Fundering - Immutatud alusraam 	10	70x45	3750
IAR3	Foundation - Fundament - Fondation - Fondamenta - Fundering - Immutatud alusraam 	1	70x45	100
A-PR1	Roof beam - Dachbalken - Panne de toit - Perlina del tetto - Gordingen / dakbalk - Pärilin 	5	44x140	4130
A-PR2	Roof beam - Dachbalken - Panne de toit - Perlina del tetto - Gordingen / dakbalk - Pärilin 	5	44x140	2620
FB1	Floor boards - Fussbodenbretter - Lame de plancher - Pavimento - Vloerhout - Põrandalaud 	43	90x18	3566
FB2	Floor boards - Fussbodenbretter - Lame de plancher - Pavimento - Vloerhout - Põrandalaud 	86	90x18	2056
	Roof boards - Dachbretter - Voliges - Perlina per tetto - Dakhout - Katuselaud 	150	90x18	2750
	Floor fillet - Fussbodenleiste - Corniere de finition du plancher - Finitura per pavimento (battisco pa) - Vloerafwerklijst - Põrandaliist 		18x18	42.28
	Roofing felt fillet - Dachpappenleiste - Baguette de fixation du feutre bitumeux - Asse per fissaggio guaina bituminosa - Afdeklijst asfaltpapier - Katusepapiliist 	4	18x58	2800
	Doorstep - Swelle - Seuil de porte - Callare - Drempeel - Lävepakk ukseavale 	1	18x44	845

Pos	01.10.2019 Piece list - Stückliste - Liste des pièces - Elementi - Stuklijst - Tükítabel Art. Nr. 4014899 12/13	Q	P (mm)	L (mm)
DRV-1	Roof edge reinforcement - Dachrandverstärkung - Corniere de renfort de bord de toit - Rinforzo x tetto - Dakrand versterking - Räästatugevdus 	4	28x34	3375
TB-1	Fascia board - Traufbrett - Bandeau de toit - Finitura lati tetto - Gevellijst Räästalaud 	4	18x90	3375
KFS-1	Storm protection - Sturmleiste - Latte anti-tempete - Protezione anti vento - Stormverankering / beveliging - Tormikinnituslijst 	6	22x45	2500
UP1	U-profile - U-profils - Profile u - Profilo ad u - U-profiel - U-profiil 	2	35x70	690
UP2	U-profile - U-profils - Profile u - Profilo ad u - U-profiel - U-profiil 	1	35x70	720
UP3	U-profile - U-profils - Profile u - Profilo ad u - U-profiel - U-profiil 	1	35x70	865
UP4	U-profile - U-profils - Profile u - Profilo ad u - U-profiel - U-profiil 	2	35x70	1930
GL1	Gable moulding - Giebelleiste - Planche de rive - Finitura per frontale e retro del tetto - Gevellijst - Viilulaud 	4	18x120	2800
GL2	Gable moulding - Giebelleiste - Planche de rive - Finitura per frontale e retro del tetto - Gevellijst - Viilulaud 	8	18x90	2800
HS8	Screw for gable segment - Schrauben für deckblatt - Vis pour fixation losange de finition - Viti x frontali tetto - Schroef voor gevelpunt segment - Kruvi rombile 	4	3.5x35	
HS9	Screw for gable moulding - Schrauben für giebelleiste - Vis pour fixation planche de rive - Vite per fissare finiture davanti e dietro del tetto - Schroef voor gevellijst - Kruvi viilulauale 	90	3.5x50	
HS4	Screw for doorstep - Schrauben für swelle - Vis pour fixation barre de seuil - Vite per soglia della porta - Schroef voor deurorpel - Kruvi lävepakule 	3	3x30	
HS4	Screw for roof edge reinforcement - Schrauben für dachrandverstärkung - Vis pour fixation corniere renfort de bord de toit - Viti x rinforzo bordo tetto - Schroef voor dakrand versterking - Kruvi räästatugevdusele 	32	3x30	
HS12	Screw for universal hook - Schrauben für universalhaken - Vis pour crochets universels - Vite per gancio universale - Schroef voor universele haak - Kruvi redeli fiksaatorile 	4	4x40	
HS13	Screw for u-profile - Schraube zur befestigung u-profils - Vis a tete fraisée pour profil u - Vite per profilo ad u - Schroef ter bevestiging u-profiel - Kruvi U-profiilile 	19	4x60	
HS13	Screw for stepladder - Schraube für leiter - Vis d'assemblage des marches de l'échelle - Vite per scaletta - Schroef voor trapladder - Kruvi redeli montaažiks 	34	4x60	
HS18	Screw for foundation - Schrauben zur befestigung fundament - Vis de fixations des poutrelles de fondations - Viti x fondamenta - Schroef voor fundering - Kruvi alusraamile 	21	5x120	
HS18	Screw for roof beams - Schrauben für dachbalken - Vis pour fixation pannes de toit - Viti per perline del tetto - Schroef voor gordingen / dakbalken - Kruvi pärlinitele 	20	5x120	
HS18	Screw for wall details - Schraube für wand details - Vis pour mur details - Viti per elementi della porta - Schroef voor wand details - Kruvi seinadetailidele 	8	5x120	
HS18	Screw for gable - Schrauben für giebel - Vis pour fixation des pignons - Viti per timpano - Schroef voor gevelpunt - Kruvi viilude kinnitamiseks 	6	5x120	
HS16	Screw for 1. wall beam - Schraube für 1. bohlenreihe - Vis de fixations 1ere rangée de madriers avec poutrelles de fondations - Vite fissaggio alle fondamenta - Schroef voor 1 wandbalk - Kruvi poollauale 	10	5x90	
HS21	Screw for beam - Schrauben zur befestigung dachsparren - Vis pour solive - Viti per perline - Schroef voor balk (gording) - Kruvi talale 	68	6x80	
NF2	Zn nail for floor fillet - Zn nagel für fussbodenleiste - Pointe pour corniere de finition du plancher - Chiodi x fissaggio pavimento - Spijker(nagel) voor vloer afdeklijst - Nael põrandaliistule 	128	1.4x40	

Pos	01.10.2019 Piece list - Stückliste - Liste des pièces - Elementi - Stuklijst - Tükitalabel Art. Nr. 4014899	13/13	Q	P (mm)	L (mm)
SH40	Hammer block - Schlagholz - Calle de frappe - Blocco di legno da usare come cuscinetto quando si usa il martello - Slagklos - Löögiklots		1		
SFS	Nut for storm protection - Schraubenmutter für sturmleiste - Ecrou pour latte anti-tempete - Dado x asta protezione vento - Moer voor stromverankering - Mutter tormikinnusliistule		12	D6	
NF4	Zn nail for roof - Zn nägel für dachbretter - Pointe pour fixation voliges de toit - Chiodi x perline tetto - Spijker(nagel) voor dakhout - Nael katuselauale		626	2x50	
NF4	Zn nail for floor - Zn nägel für fusbodenbretter - Clous pour plancher - Chiodi x perline pavimento - Spijker(nagel) voor vloer - Nael põrandalauale		828	2x50	
NF5	Zn nail for roofing felt fillet - Zn nägel für dachpappenleiste - Pointe pour baguette de fixation feutre bitumeux - Chiodi x carta bituminosa x tetto - Spijker(nagel) voor asfaltpapier afdeklijst - Papiliistunael		28	2x40	
BFS	Bolt for storm protection - Bolzen für sturmleiste - Boulon pour latte anti-tempete - Bullone x asta protezione vento - Bout voor stormankerlat - Puidupolt tormikinnusliistule		12	6x70	
	Ladder - Leiter - Echelle - Scala a pioli - Ladder - Redel		1		
	Ladder clamp - Leiter klemme - Fixation de echelle - Uncino di metallo per fissare la sommità della scala a pioli - Ladderklem - Redeli fiksaator		2		
GS	Gable segment - Deckblatt - Losange de finition - Decorazione in legno x frontale tetto - Gevelpunt segment - Romb		2		
DFS	Washer for storm protection - Dichtscheibe für sturmleiste - Rondelle pour latte anti-tempete - Rondella x asta protezione vento - Afdichtring voor storm strip - Seib tormikinnusliistule		12	D6	

Doors and windows are not included. They can be bought extra as 9900400 - Caroline B / 9900500 Caroline A

Die fenster und türen gehören nicht zum lieferumfang und können separaat bestellt werden.

La porte et les fenêtrés ne sont pas incluses avec l'abri. Elles sont disponibles en option sous la référence 9900400 - Caroline B / 9900500 Caroline A

Porte e finestre non sono incluse. Possono essere aggiunti per extra come 9900400 - Caroline B / 9900500 Caroline A

Deuren en Ramen worden niet geleverd in dit pakket, u kan deze apart bestellen met art 9900400 - Caroline B / 9900500 - Caroline A

Uks ja aknad pole maja komplektis. Neid saab soetada eraldi lisapakina 9900400 - Caroline B / 9900500 Caroline A