

Mekong XL
Art.No. 7012641

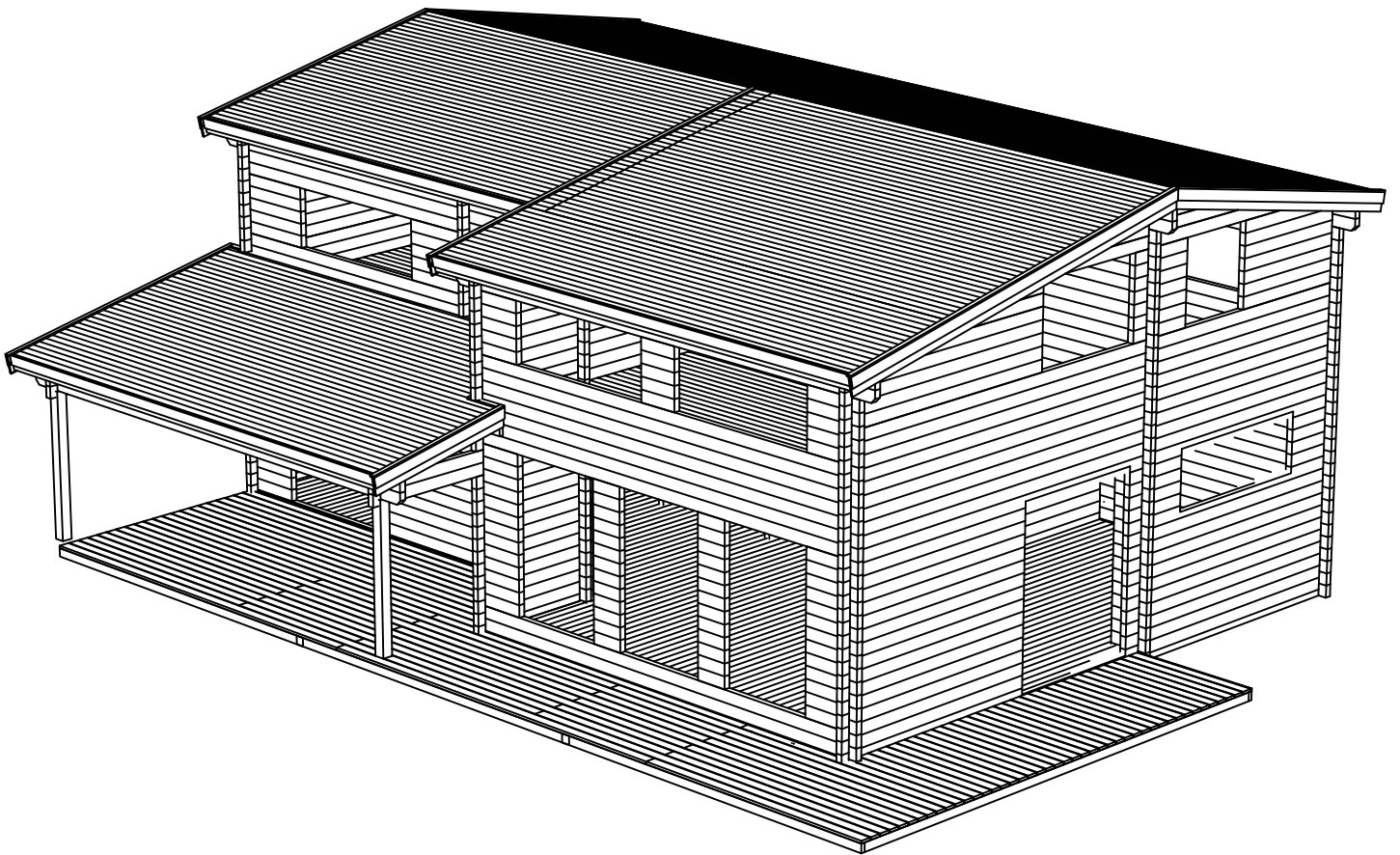

Mekong XL, Art.No.7012641
 GRUNDPLAN - GRUNDPLAN - PLAN DE MASSE

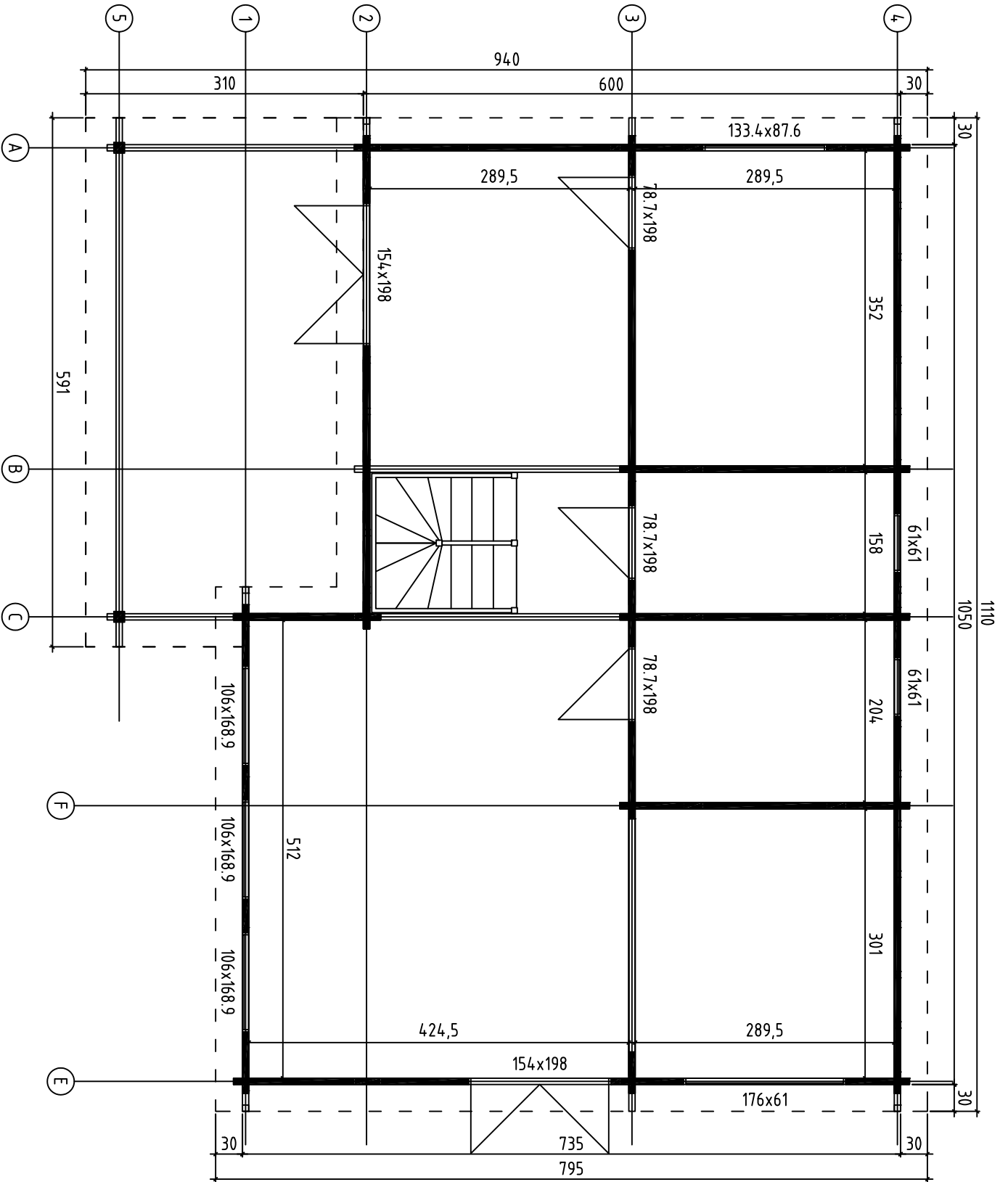

Mekong XL, Art.No.7012641
GRUNDPLAN - GRUNDPLAN - PLAN DE MASSE

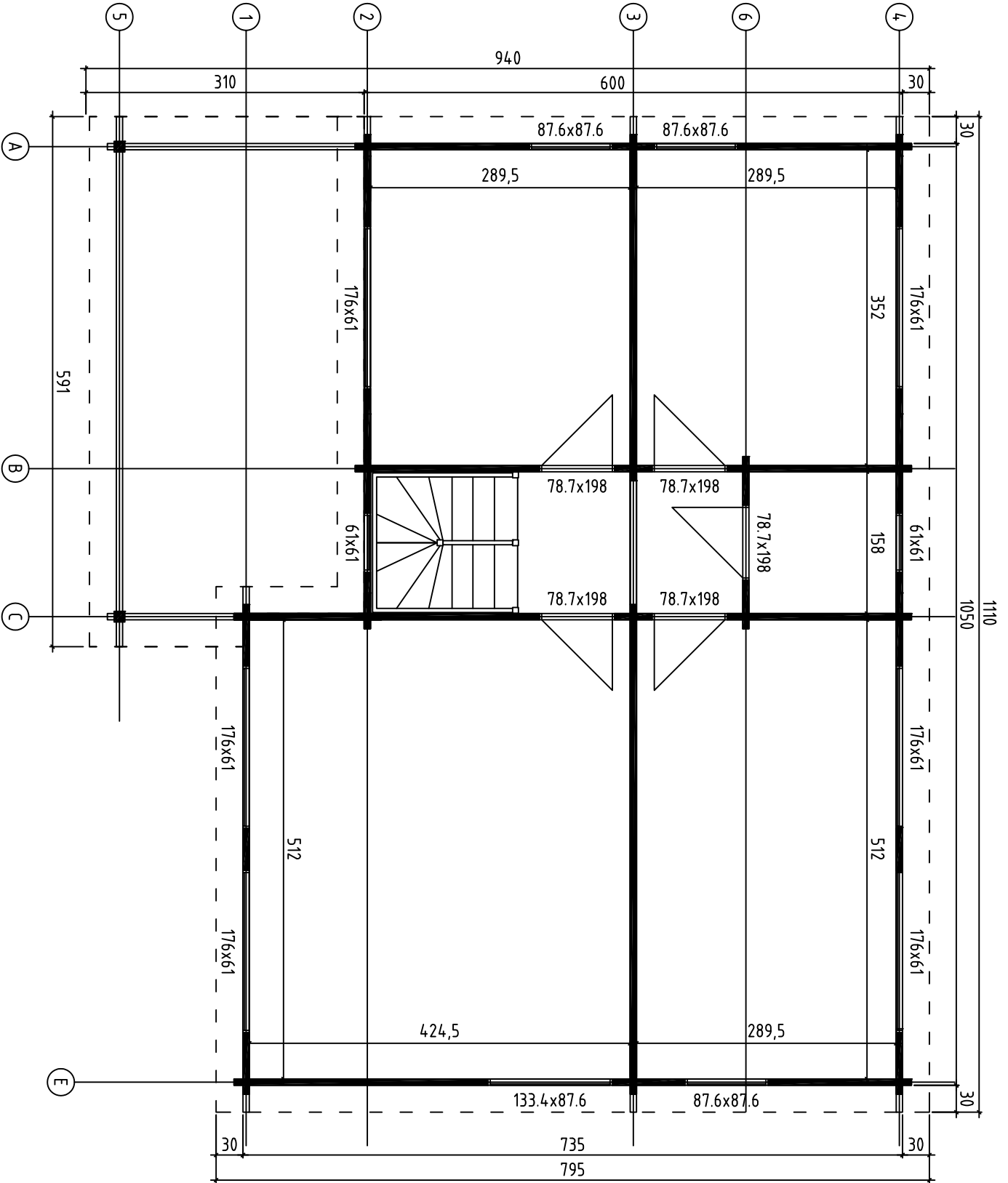

Mekong XL, Art.No.7012641
FOUNDATION - FUNDAMENT - FONDATION

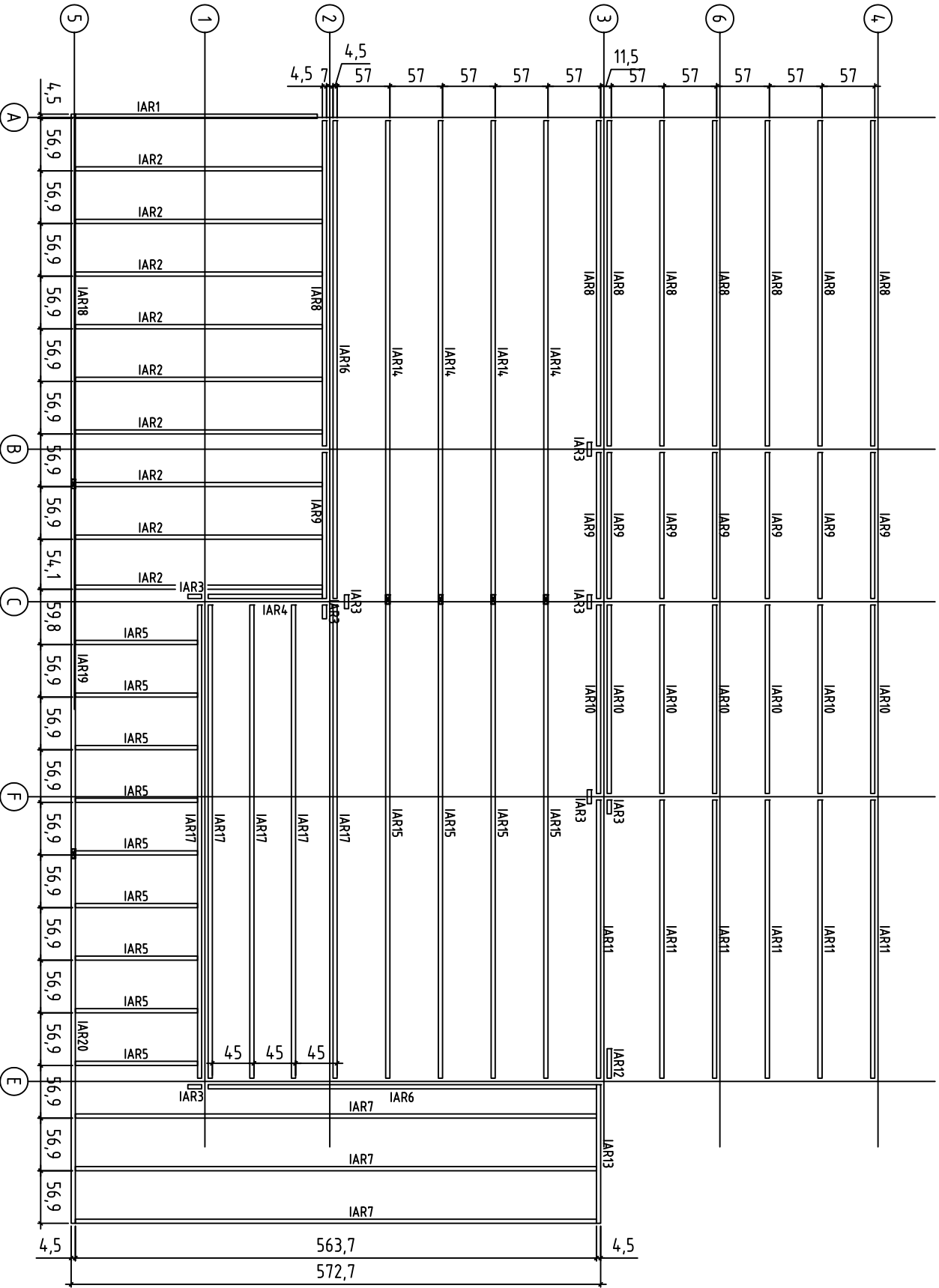

Mekong XL, Art.No.7012641
 RAFTERS PLAN - DACHSPARREN - PLAN DE CHEVRON

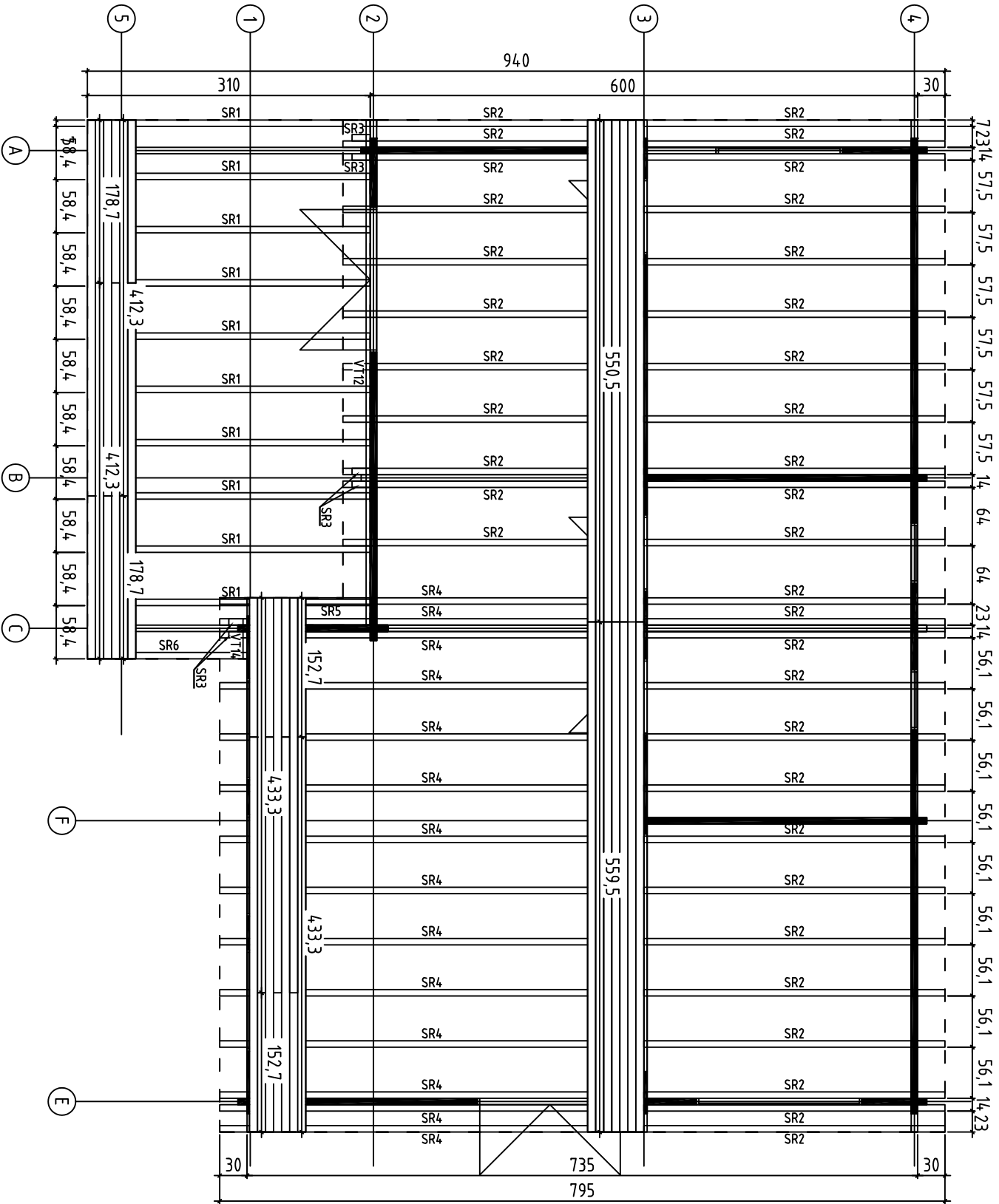

Mekong XL, Art.No.7012641
 MEZZANINE FLOOR JOISTS - HALBGESCHOSS BALKEN - SOLIVES DE PLANCHER MEZZANINE

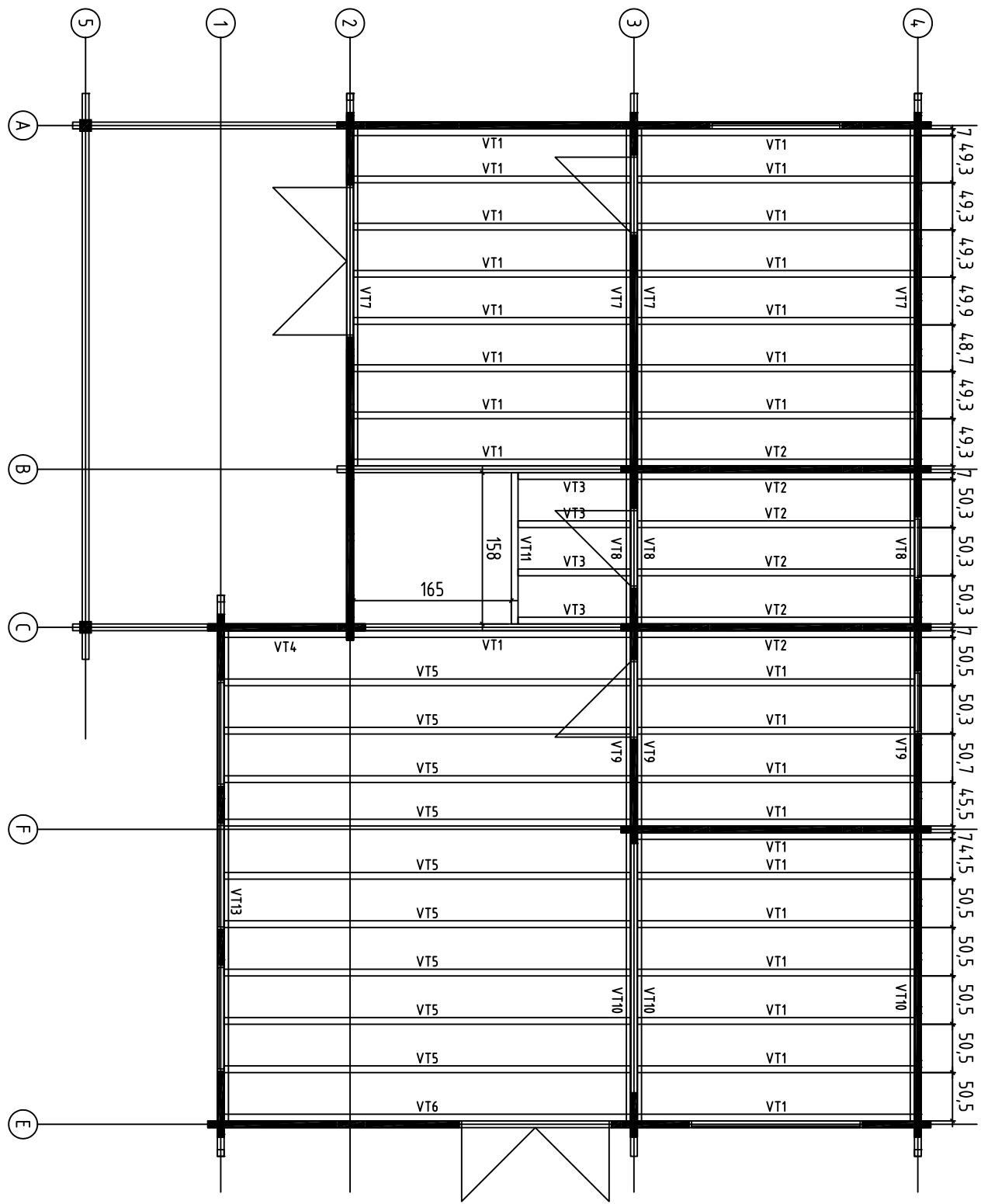

Mekong XL, Art.No.7012641
FLOOR BOARDS - FUSSBODENBRETTER - PLAN POSE PLANCHER

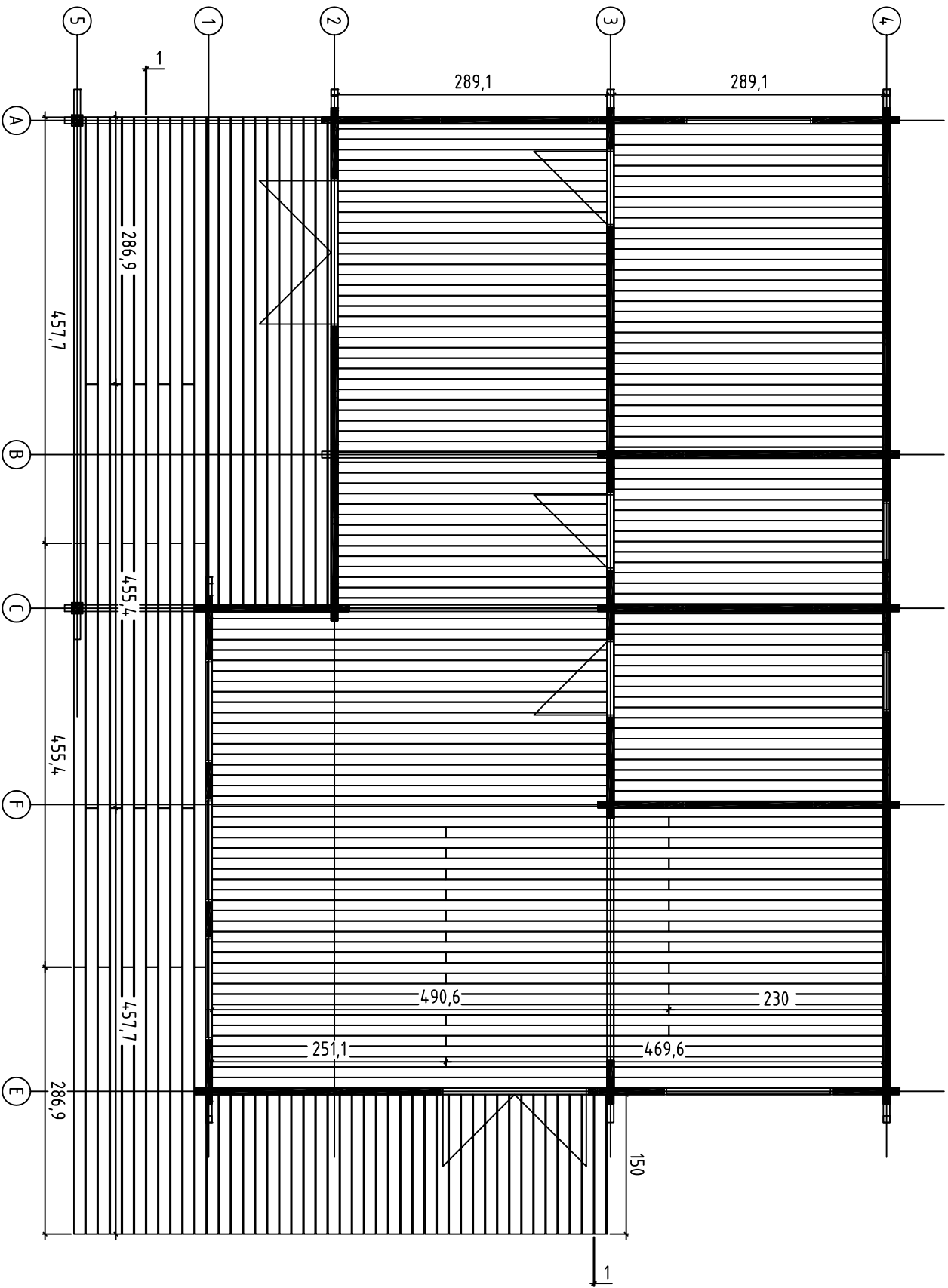

Mekong XL, Art.No.7012641
FLOOR BOARDS - FUSSBODENBRETTER - PLAN POSE PLANCHER

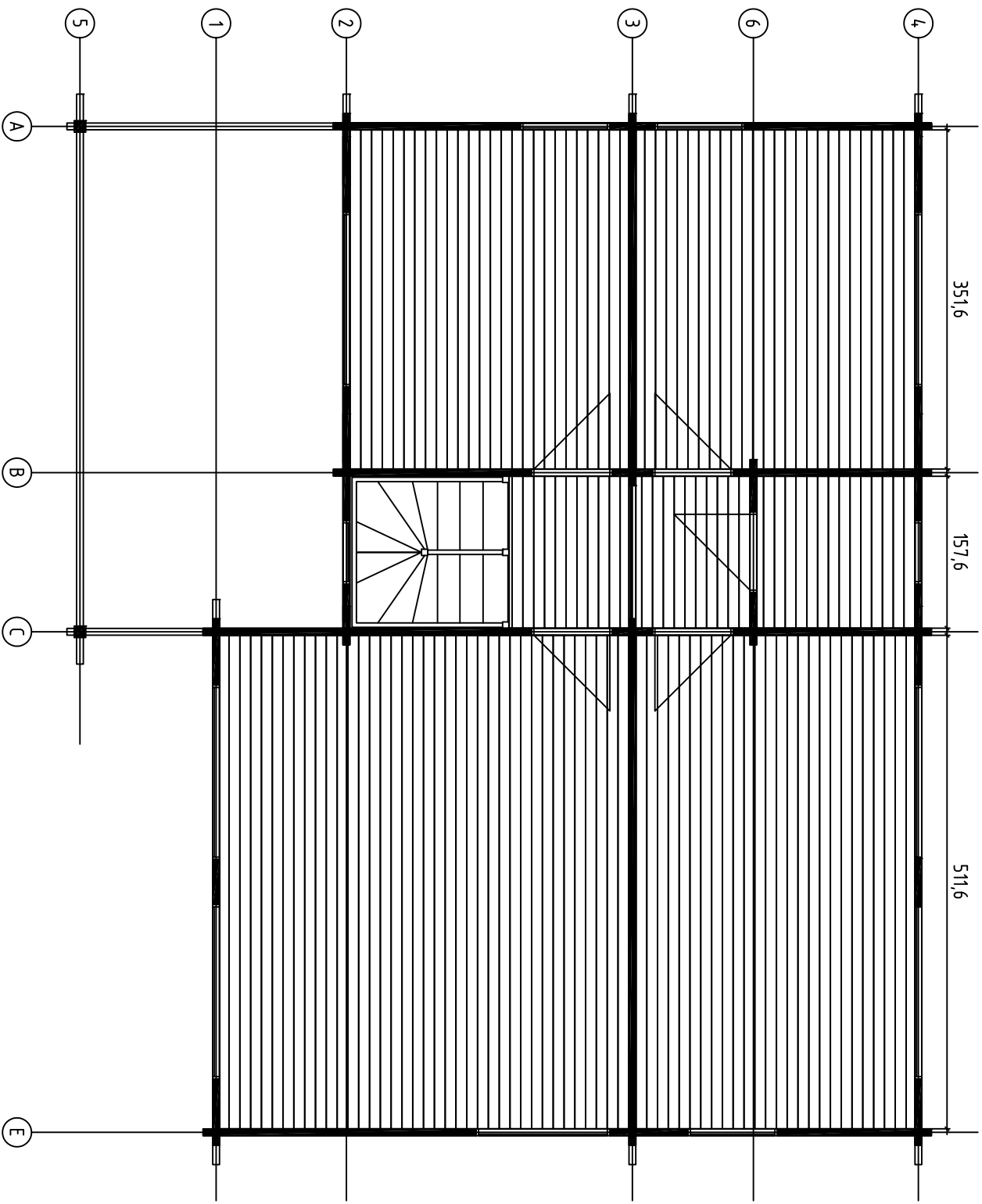

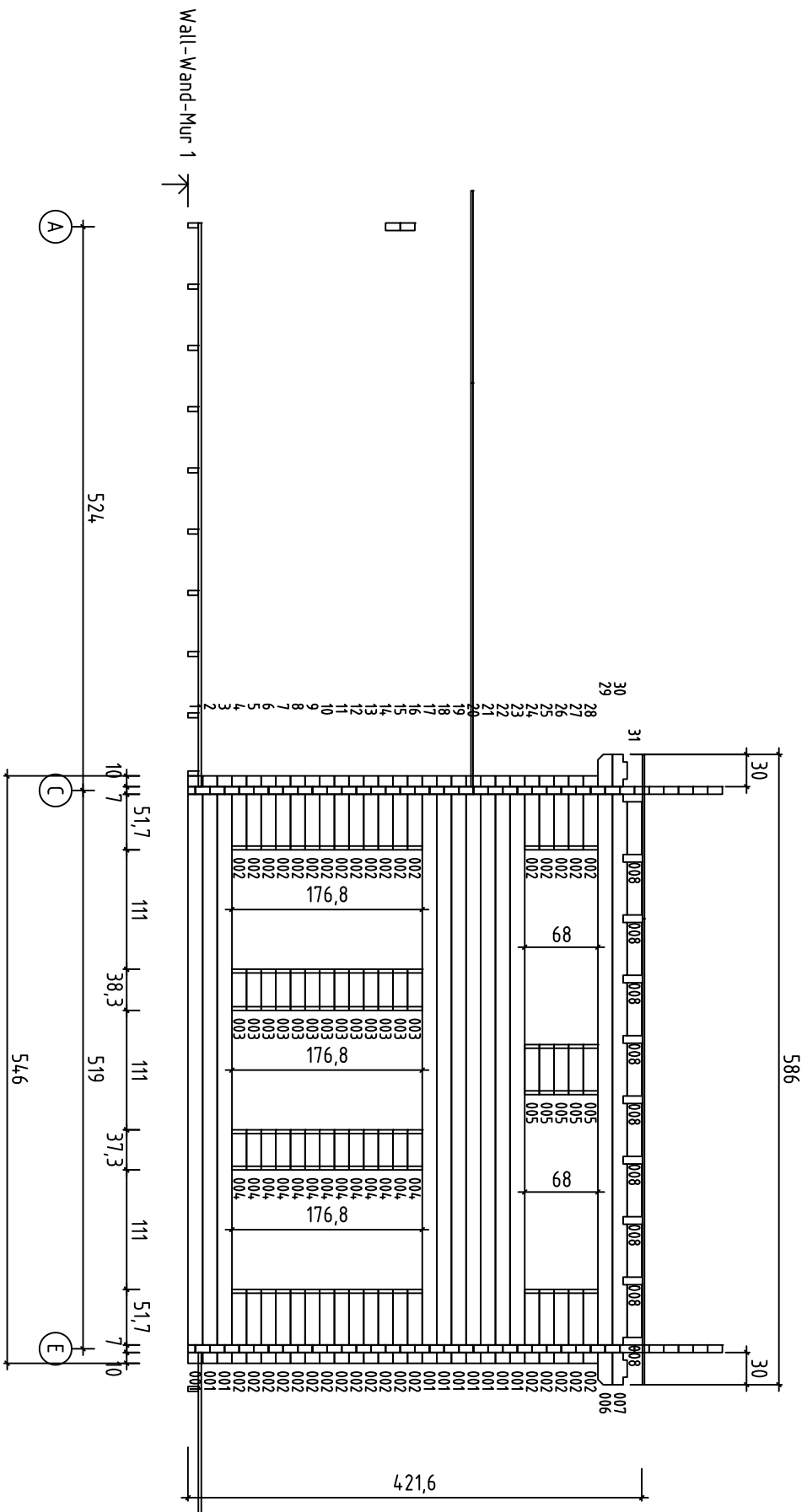

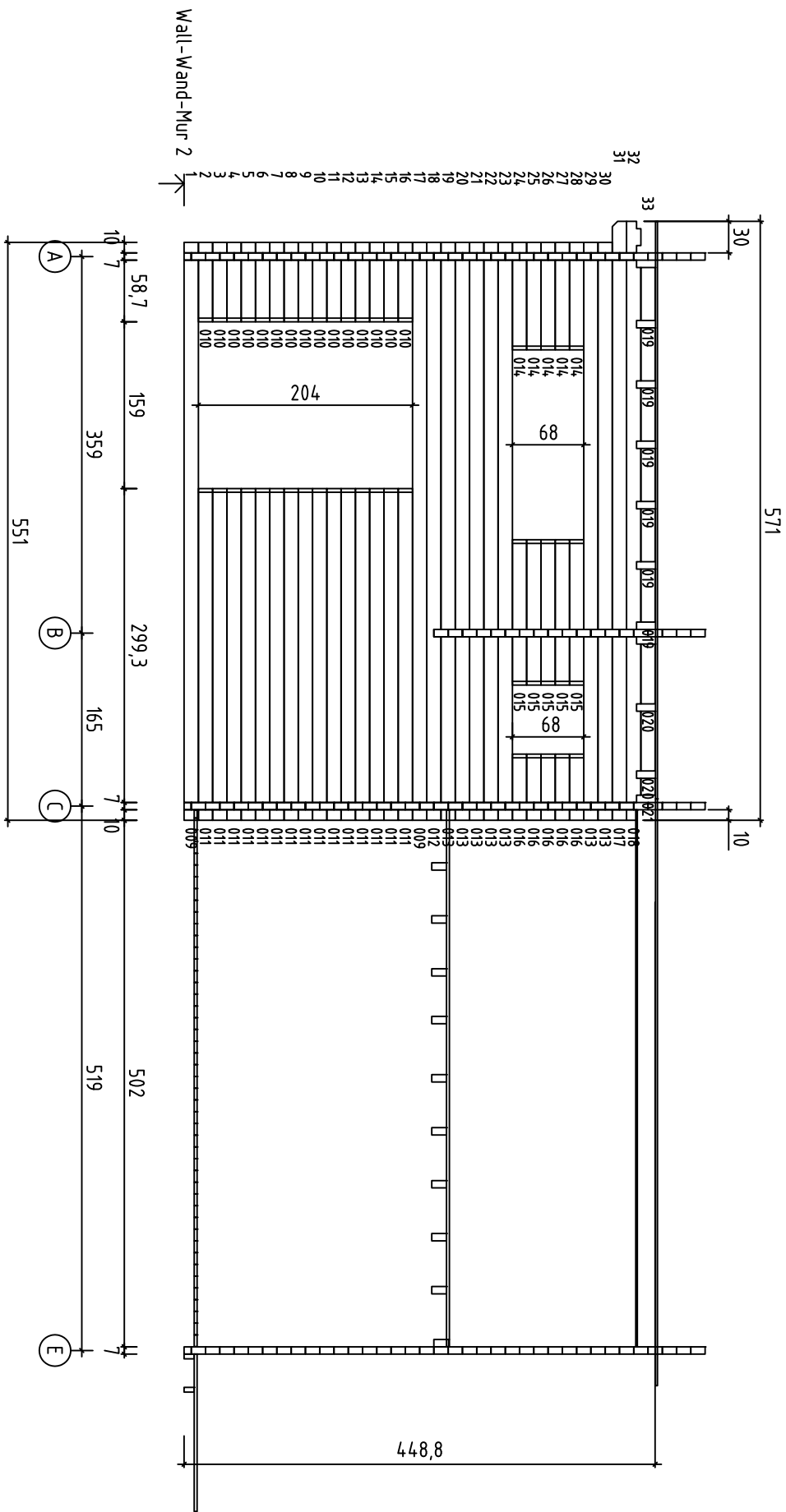

Wall-Wand-Mur 2

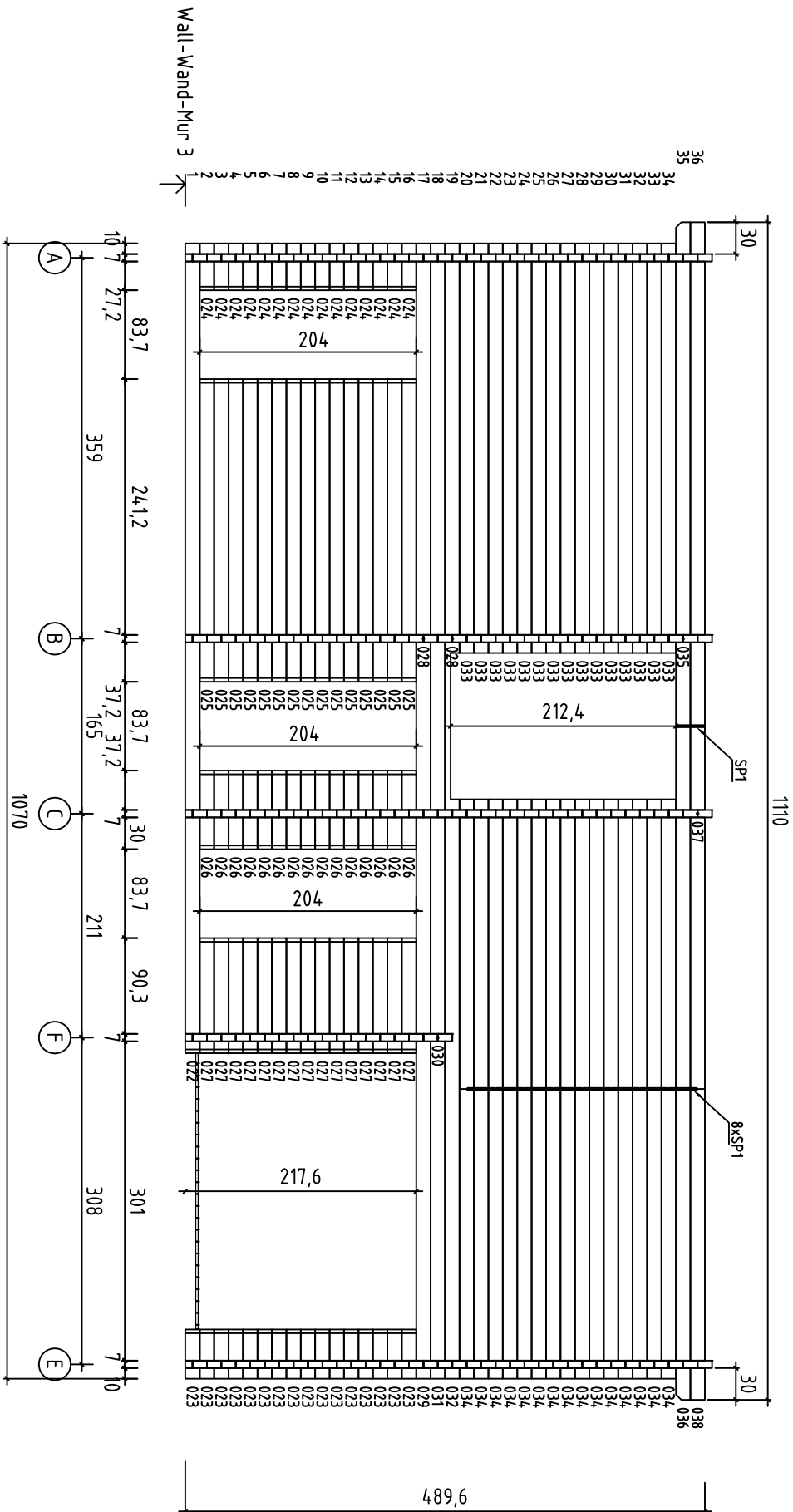

1110

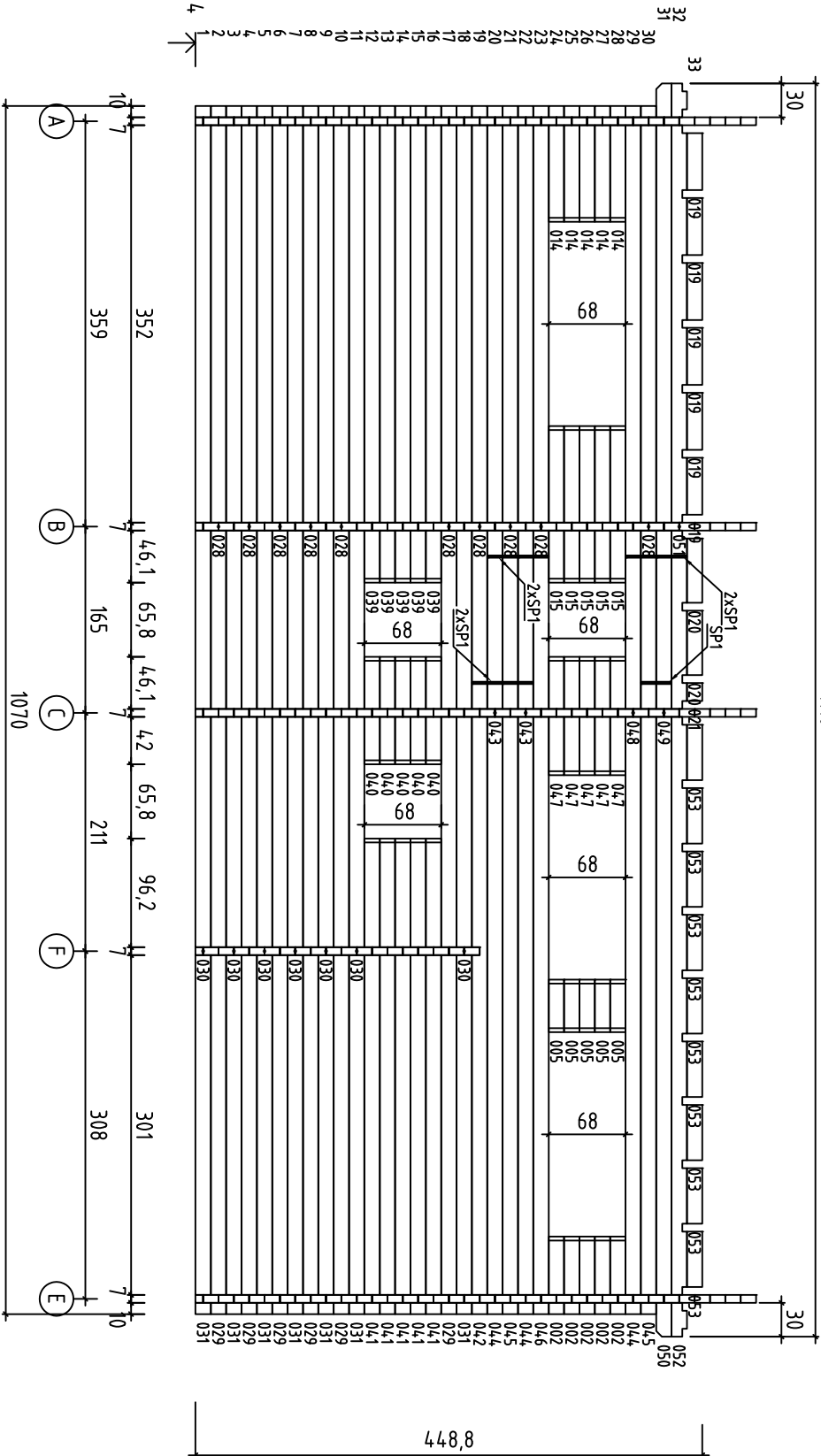

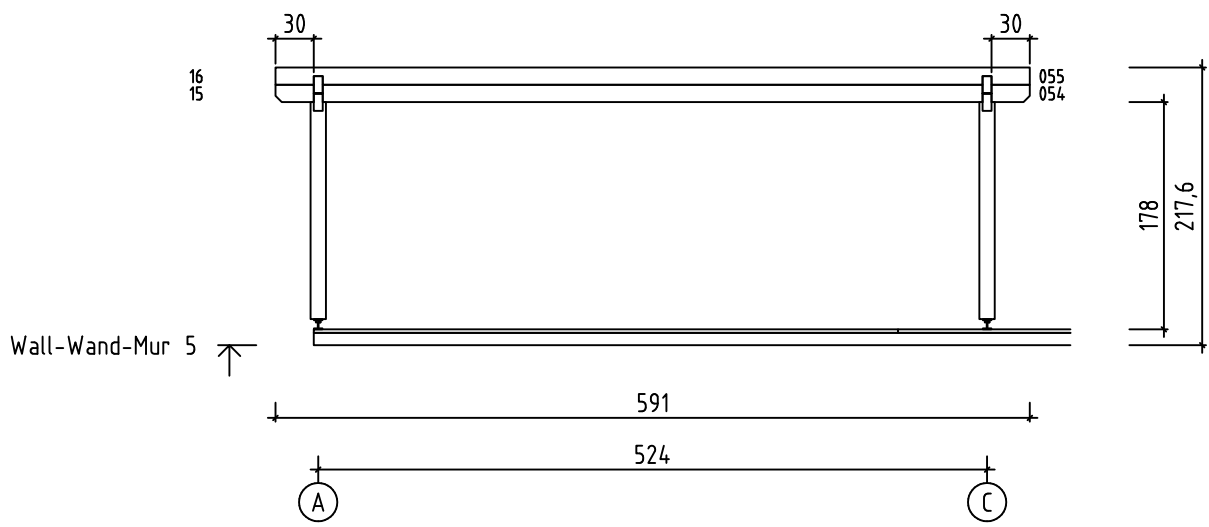

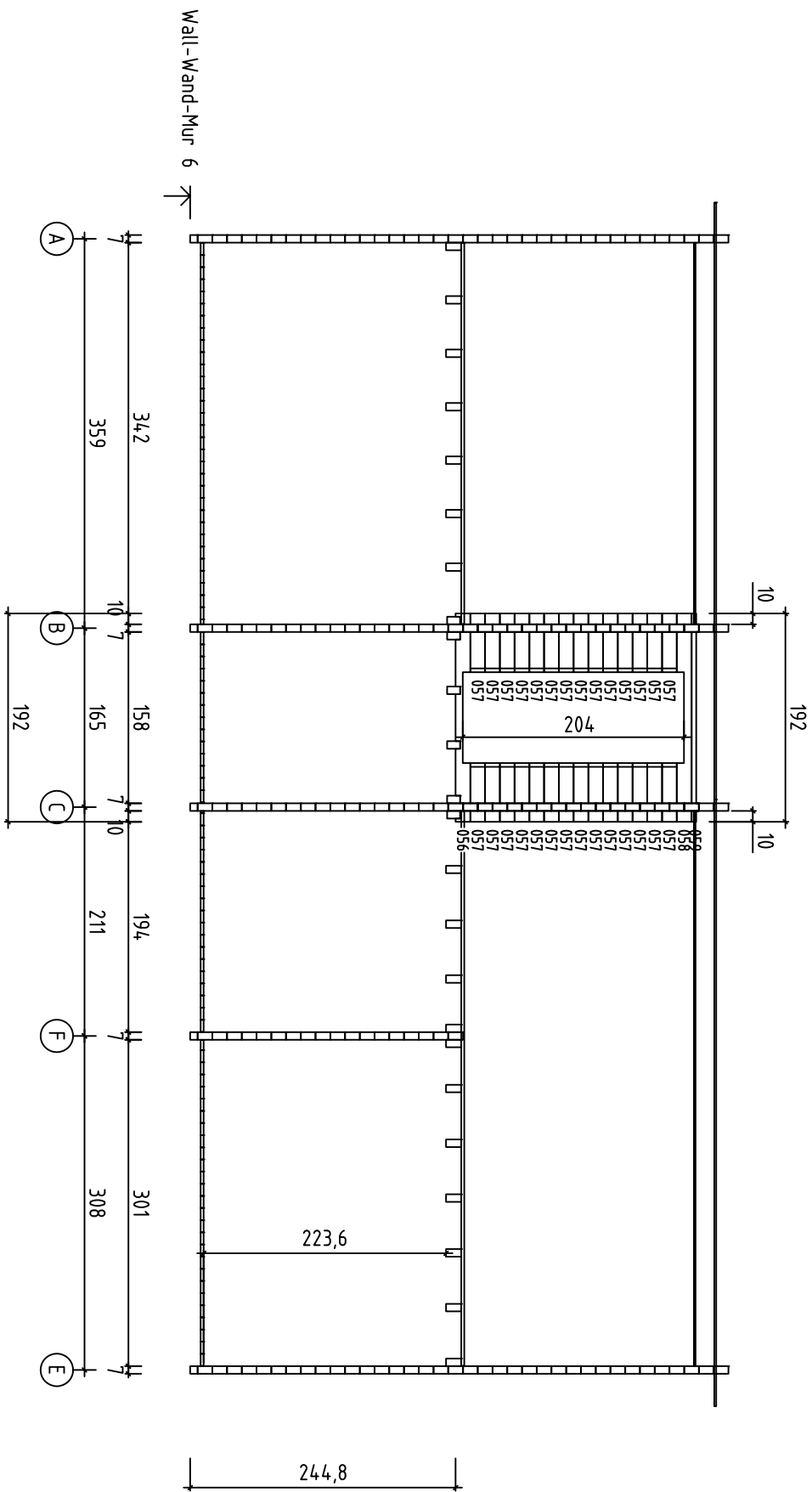

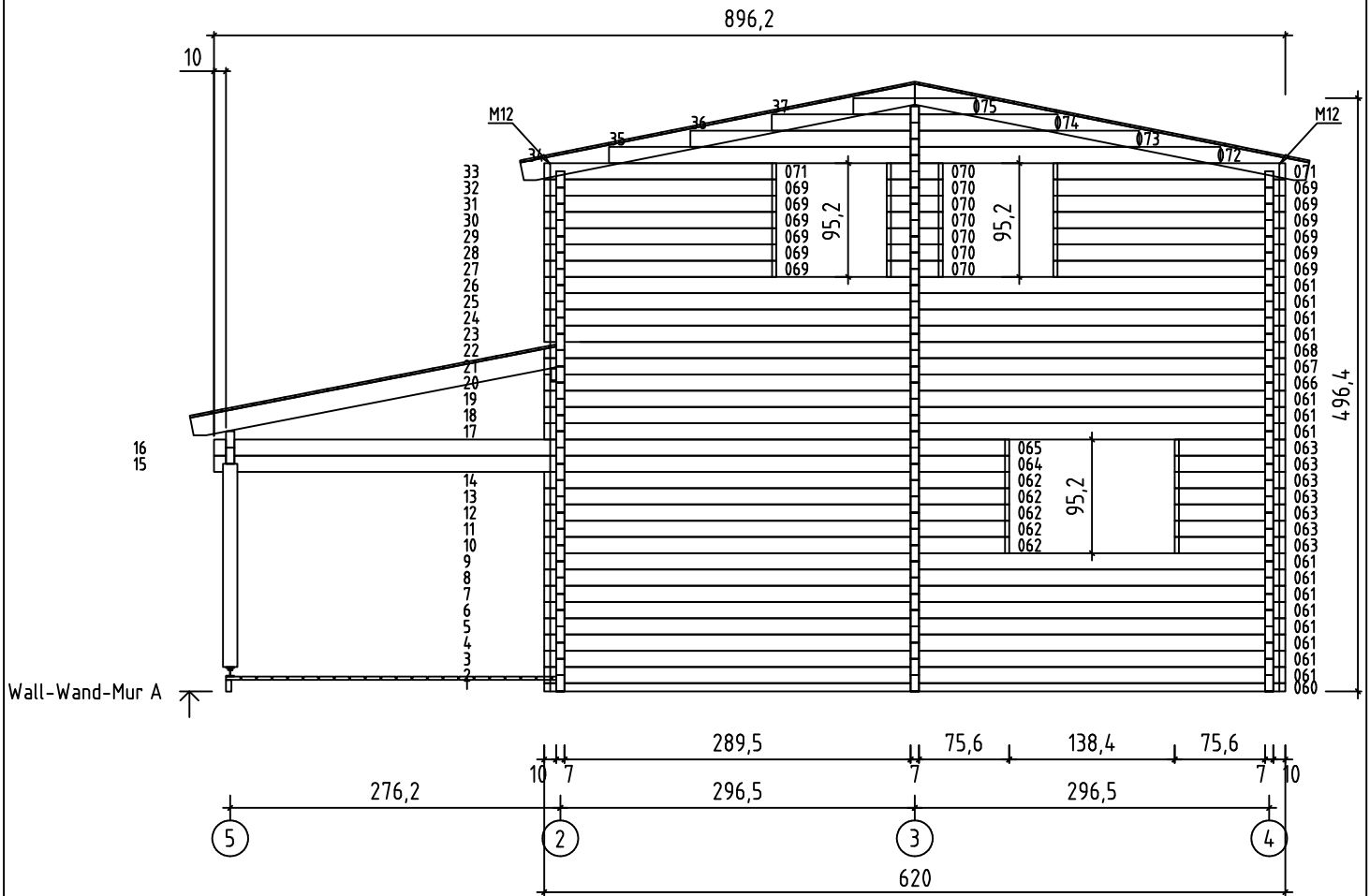

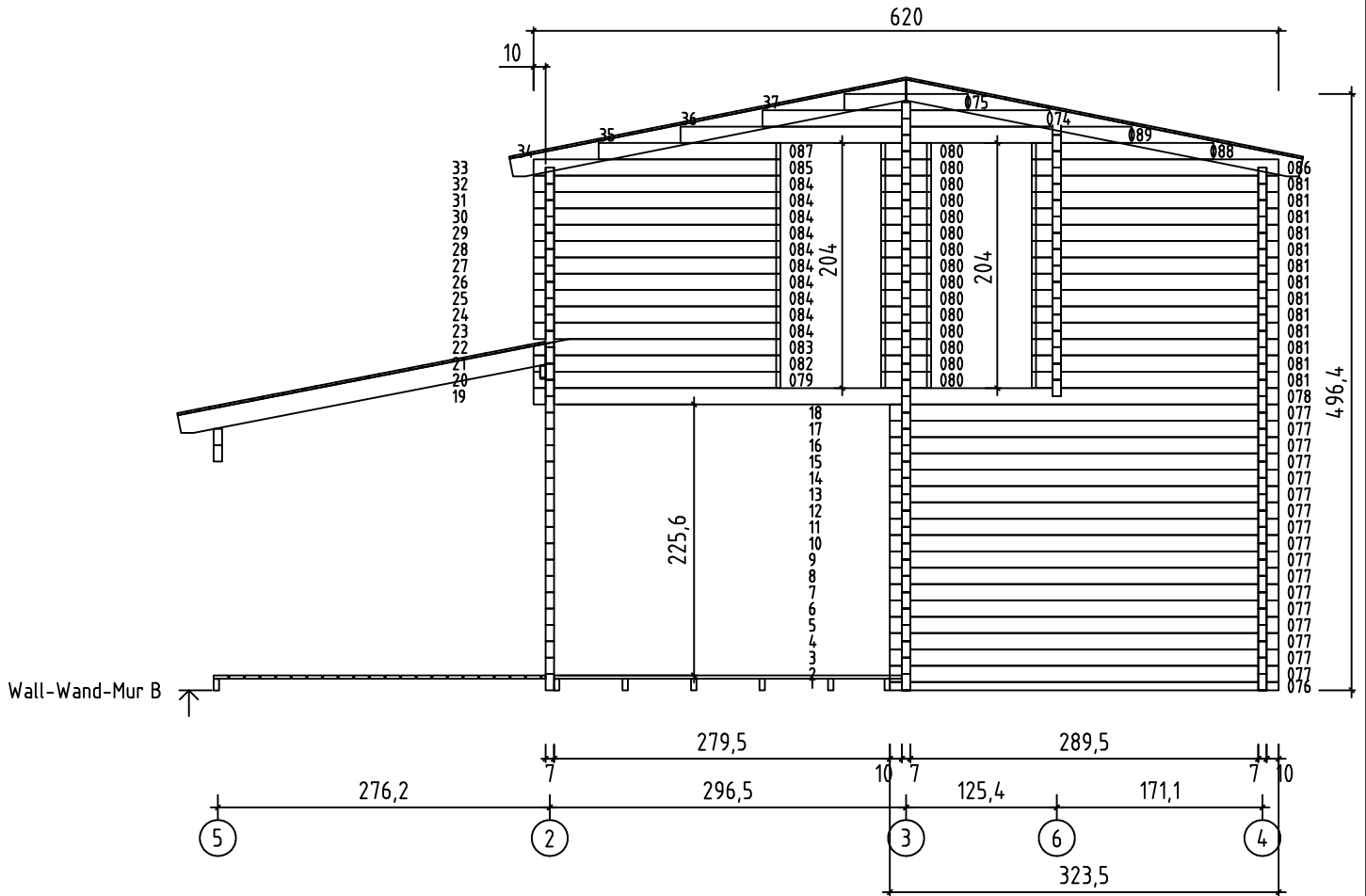

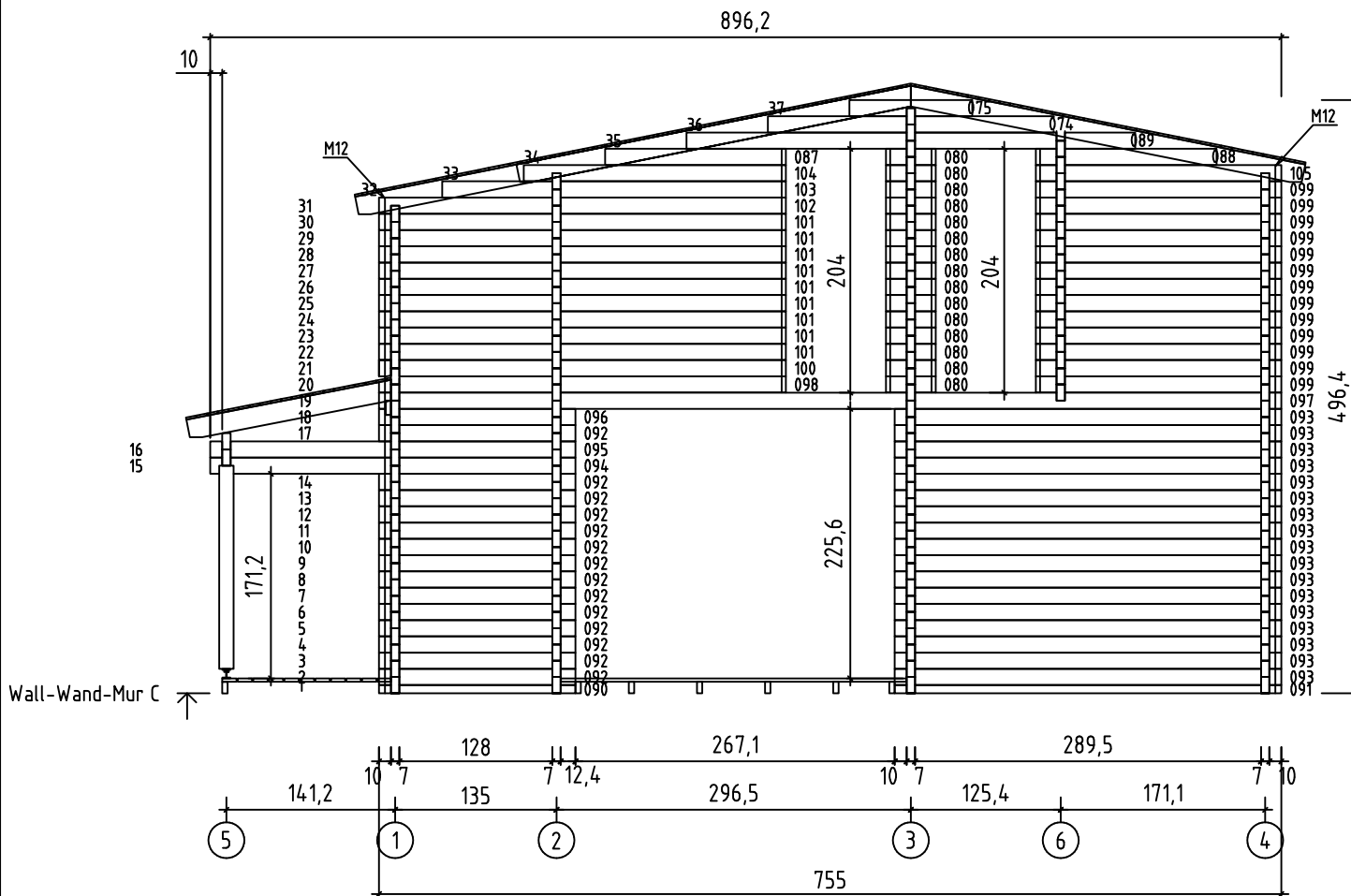

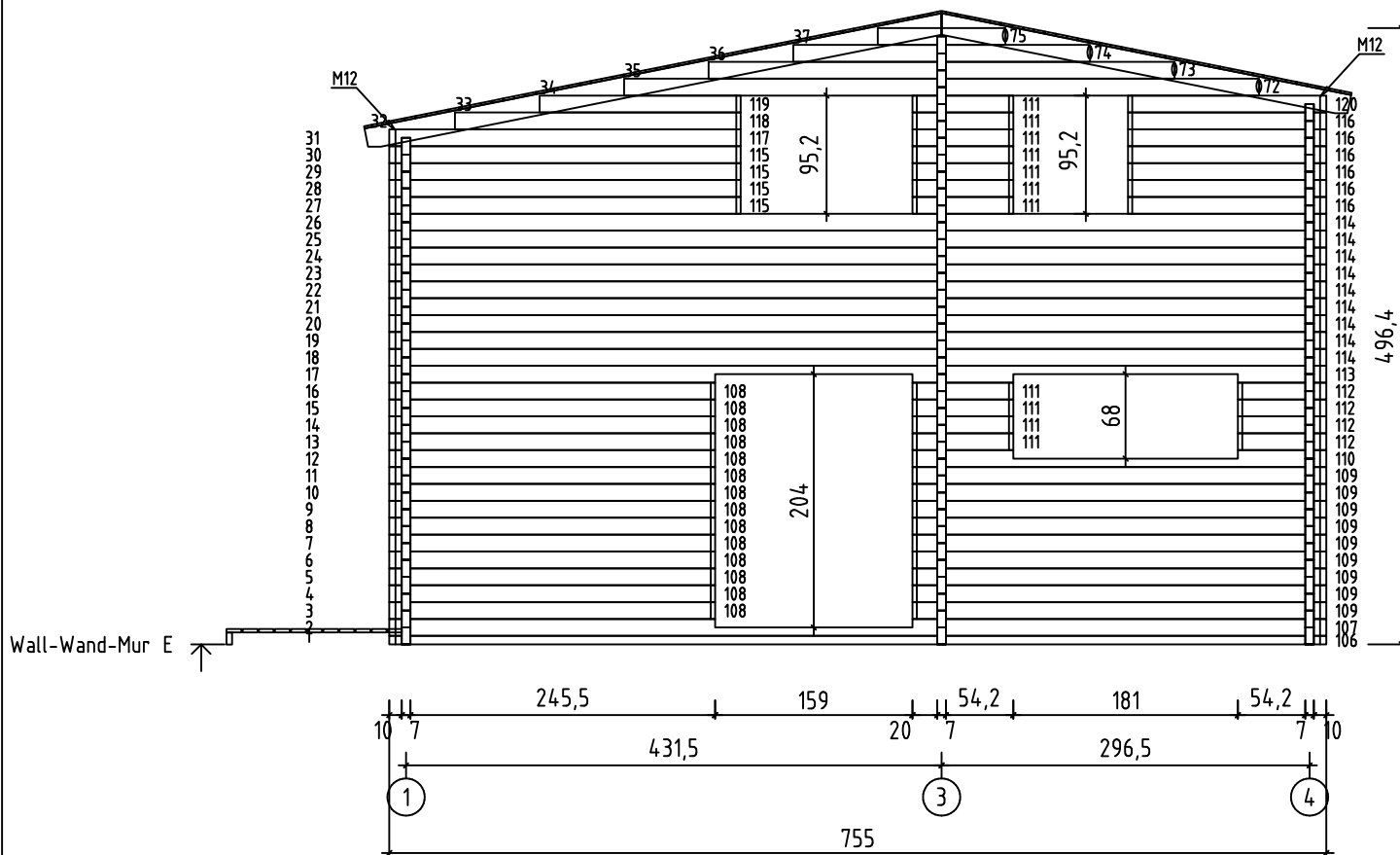

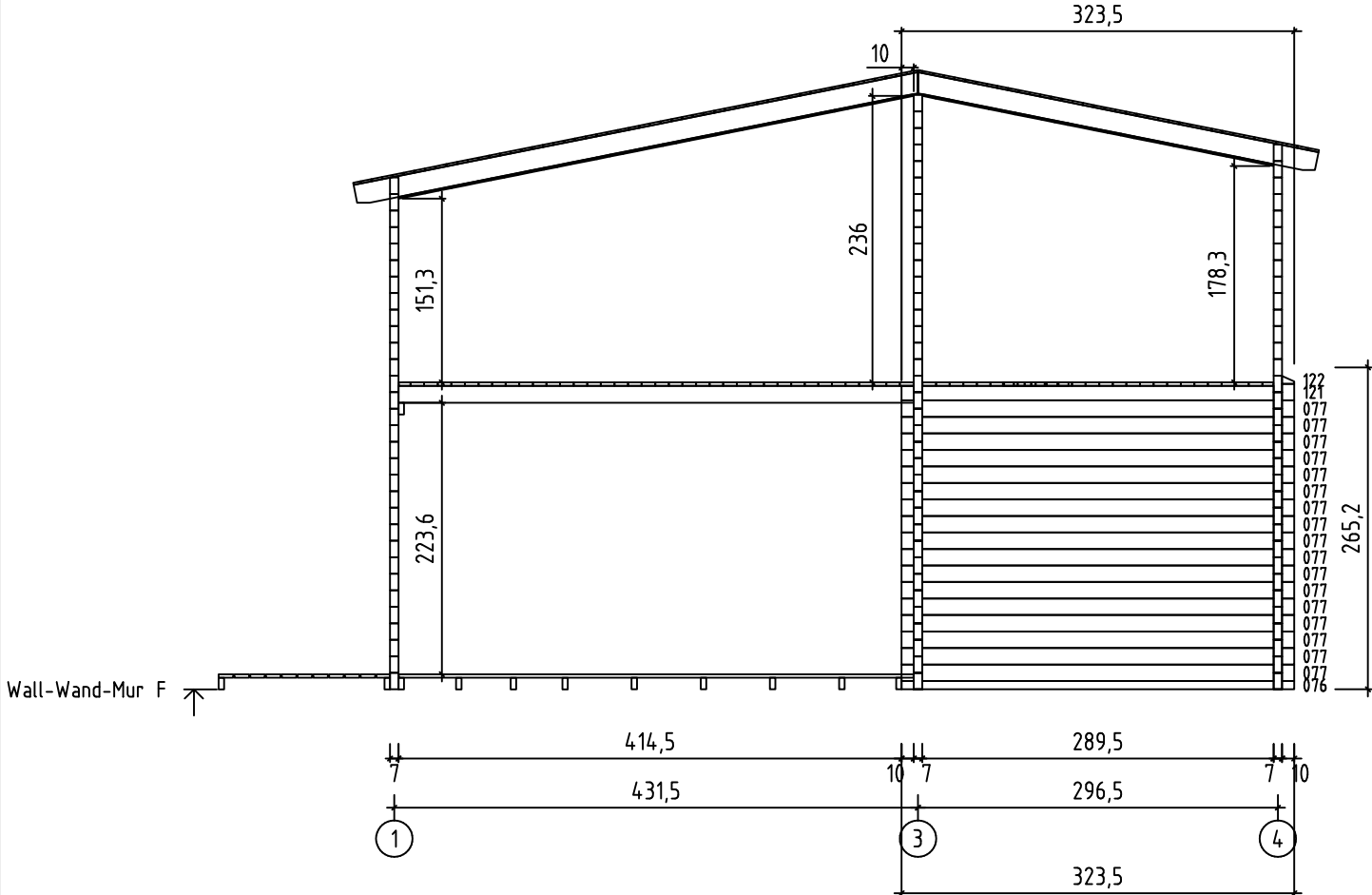

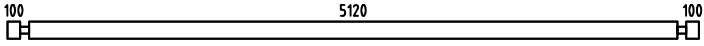
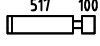



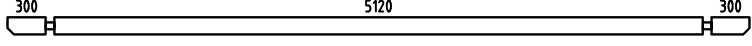
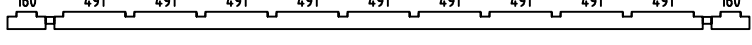

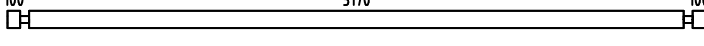
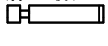
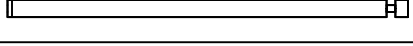
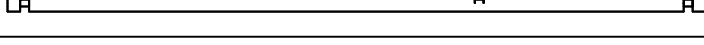
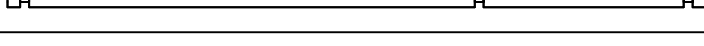
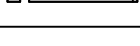
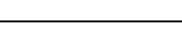

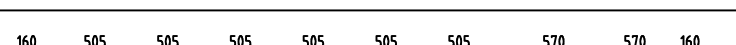
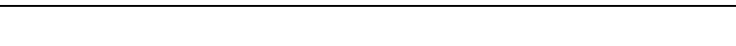



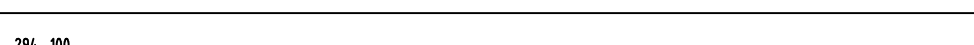





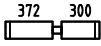
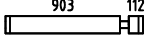
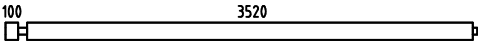
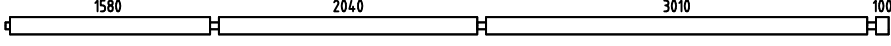
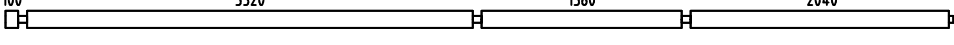
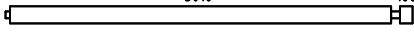
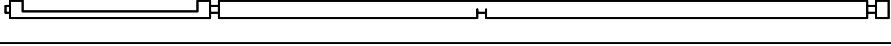
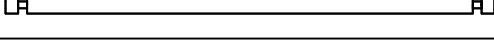
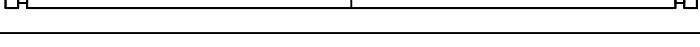
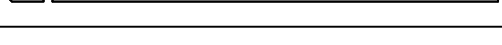
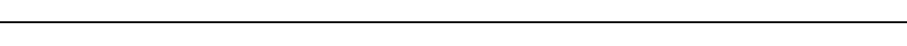
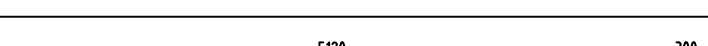
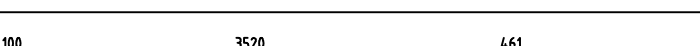
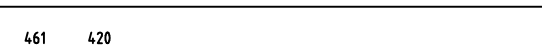
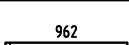

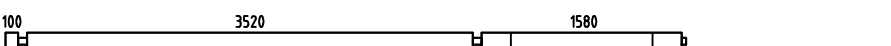
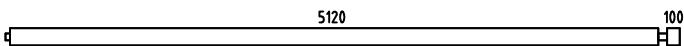
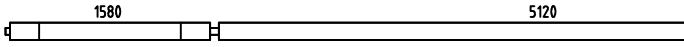
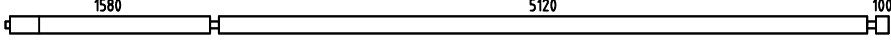

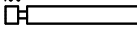
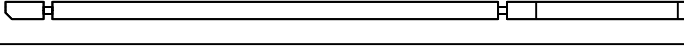
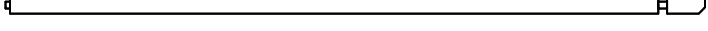





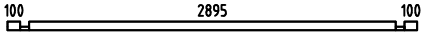
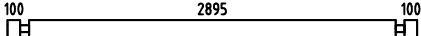
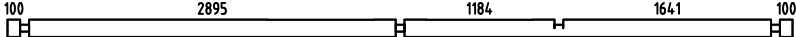
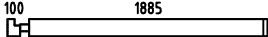

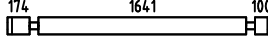
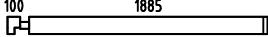
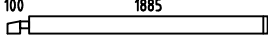
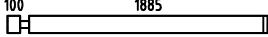
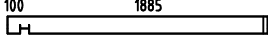
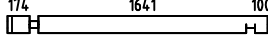
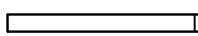
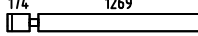
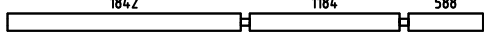
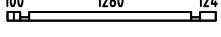
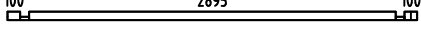
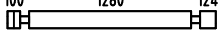
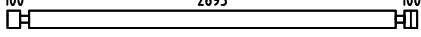
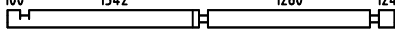
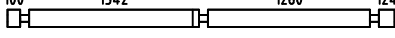
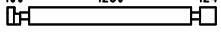
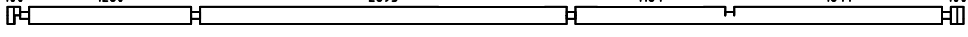
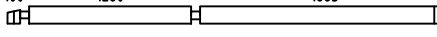
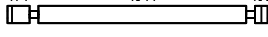
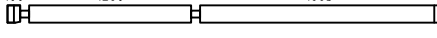

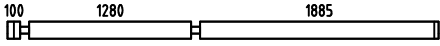
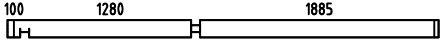
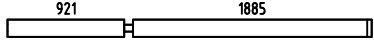
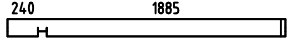
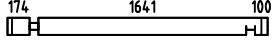
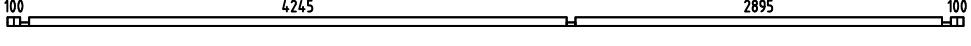
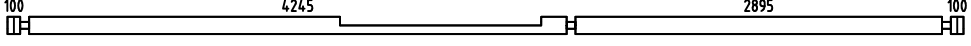
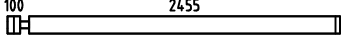
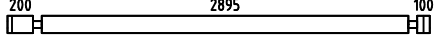
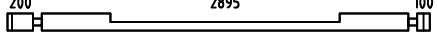
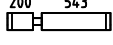
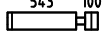
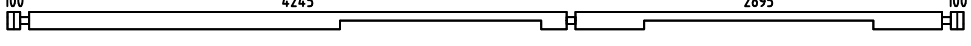
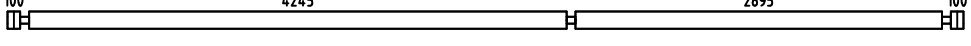
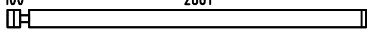
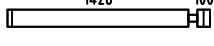
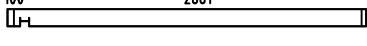
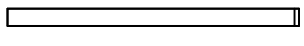
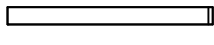
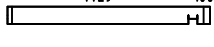
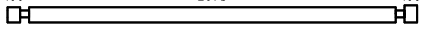

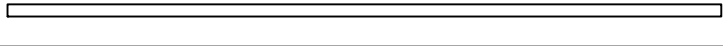
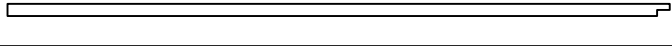
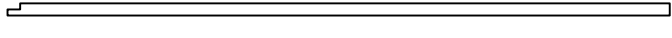
Pos	Mekong XL, Art.No.7012641 Piece list - Stückliste - Liste des pieces	Q.	P (mm)	L (mm)
001		10	70x136	5460
002		41	70x136	687
003		13	70x136	383
004		13	70x136	373
005		10	70x136	466
006		1	70x136	5860
007		1	70x136	5860
008		9	70x136	491
009		2	70x136	5510
010		15	70x136	757
011		15	70x136	3163
012		1	70x136	5510
013		7	70x136	5510
014		10	70x136	1025
015		10	70x136	1386
016		5	70x136	631
017		1	70x136	5710
018		1	70x136	5710
019		12	70x136	505
020		4	70x136	570
021		2	70x136	160
022		1	70x136	7632
023		16	70x136	464
024		15	70x136	441
025		15	70x136	2853

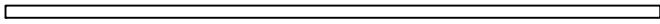
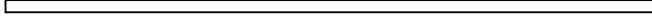
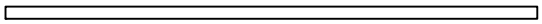
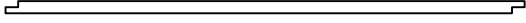
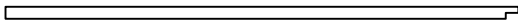

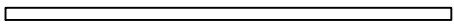
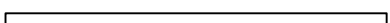
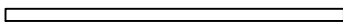
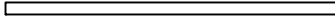
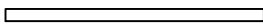
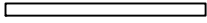
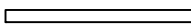
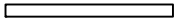
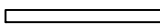

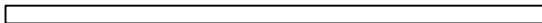
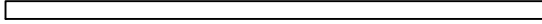
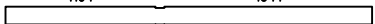

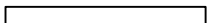
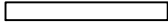
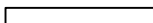



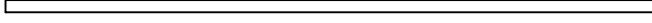
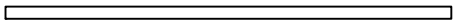
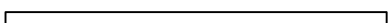
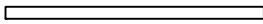

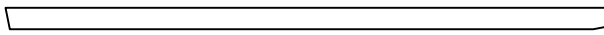
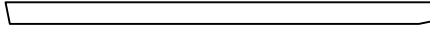
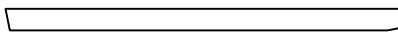
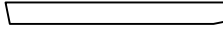
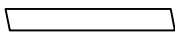

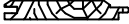

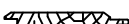
Pos	Mekong XL, Art.No.7012641 Piece list - Stückliste - Liste des pieces	Q.	P (mm)	L (mm)
026		15	70x136	742
027		15	70x136	1085
028		12	70x136	3725
029		7	70x136	6975
030		8	70x136	7485
031		8	70x136	3215
032		1	70x136	6975
033		15	70x136	3860
034		15	70x136	5460
035		1	70x136	3925
036		1	70x136	7175
037		1	70x136	5575
038		1	70x136	5525
039		5	70x136	4221
040		5	70x136	951
041		5	70x136	4212
042		1	70x136	6975
043		2	70x136	5375
044		3	70x136	5325
045		2	70x136	6975
046		1	70x136	6975
047		5	70x136	1048
048		1	70x136	5375
049		1	70x136	5575
050		1	70x136	5525

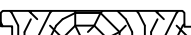



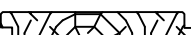









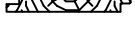
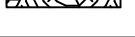



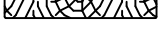
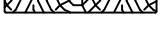



Pos	Mekong XL, Art.No.7012641 Piece list - Stückliste - Liste des pieces	Q.	P (mm)	L (mm)
051		1	70x136	3925
052		1	70x136	7175
053		9	70x136	491
054		1	70x136	5910
055		1	70x136	5910
056		1	70x136	1920
057		28	70x136	541
058		1	70x136	1920
059		1	70x68	1920
060		1	70x68	6200
061		15	70x136	6200
062		5	70x136	3891
063		7	70x136	926
064		1	70x136	6653
065		1	70x136	6653
066		1	70x136	6200
067		1	70x136	6200
068		1	70x136	6200
069		12	70x136	1941
070		7	70x136	470
071		2	70x136	1941
072		2	70x136	5117
073		2	70x136	3754
074		4	70x136	2391
075		4	70x136	1029









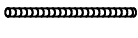







Pos	Mekong XL, Art.No.7012641 Piece list - Stückliste - Liste des pieces	Q.	P (mm)	L (mm)
076		2	70x68	3235
077		34	70x136	3235
078		1	70x136	6200
079		1	70x136	2055
080		28	70x136	417
081		12	70x136	2055
082		1	70x136	2055
083		1	70x136	2055
084		10	70x136	2055
085		1	70x136	2055
086		1	70x136	2055
087		2	70x136	1513
088		2	70x136	1513
089		2	70x136	3754
090		1	70x68	1644
091		1	70x68	3235
092		14	70x136	1644
093		17	70x136	3235
094		1	70x136	3056
095		1	70x136	3056
096		1	70x136	1644
097		1	70x136	7550
098		1	70x136	3405
099		12	70x136	2055
100		1	70x136	3405





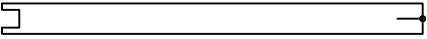
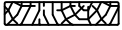



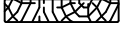
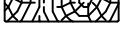
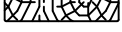
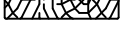
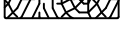
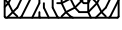
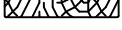
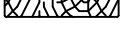

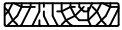
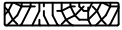
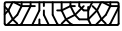

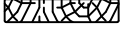





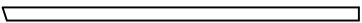
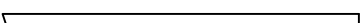

Pos	Mekong XL, Art.No.7012641 Piece list - Stückliste - Liste des pieces	Q.	P (mm)	L (mm)
101		9	70x136	3405
102		1	70x136	3405
103		1	70x136	2875
104		1	70x136	2194
105		1	70x136	2055
106		1	70x68	7550
107		1	70x136	7550
108		14	70x136	2625
109		9	70x136	3335
110		1	70x136	3335
111		11	70x136	813
112		4	70x136	713
113		1	70x136	7550
114		9	70x136	7550
115		4	70x136	2831
116		6	70x136	1598
117		1	70x136	2831
118		1	70x136	2302
119		1	70x136	1621
120		1	70x136	1599
121		1	70x136	3235
122		1	70x65	100
IAR7	FOUNDATION - FUNDAMENT - FONDAION 	3	45x96	5637
IAR14	FOUNDATION - FUNDAMENT - FONDAION 	4	45x96	5230
IAR15	FOUNDATION - FUNDAMENT - FONDAION 	4	45x96	5230

Pos	Mekong XL, Art.No.7012641 Piece list - Stückliste - Liste des pieces	Q.	P (mm)	L (mm)
IAR16	FOUNDATION - FUNDAMENT - FONDATION 	1	45x96	5170
IAR17	FOUNDATION - FUNDAMENT - FONDATION 	5	45x96	5120
IAR6	FOUNDATION - FUNDAMENT - FONDATION 	1	45x96	4200
IAR19	FOUNDATION - FUNDAMENT - FONDATION 	1	45x96	4100
IAR18	FOUNDATION - FUNDAMENT - FONDATION 	1	45x96	4050
IAR20	FOUNDATION - FUNDAMENT - FONDATION 	1	45x96	4050
IAR8	FOUNDATION - FUNDAMENT - FONDATION 	8	45x96	3520
IAR11	FOUNDATION - FUNDAMENT - FONDATION 	6	45x96	3010
IAR2	FOUNDATION - FUNDAMENT - FONDATION 	9	45x96	2672
IAR1	FOUNDATION - FUNDAMENT - FONDATION 	1	45x96	2617
IAR10	FOUNDATION - FUNDAMENT - FONDATION 	7	45x96	2040
IAR9	FOUNDATION - FUNDAMENT - FONDATION 	8	45x96	1580
IAR13	FOUNDATION - FUNDAMENT - FONDATION FOUNDATION - FUNDAMENT - FONDATION 	1	45x96	1500
IAR5	FOUNDATION - FUNDAMENT - FONDATION 	9	45x96	1322
IAR4	FOUNDATION - FUNDAMENT - FONDATION 	1	45x96	1235
IAR12	FOUNDATION - FUNDAMENT - FONDATION 	1	45x96	320
IAR3	FOUNDATION - FUNDAMENT - FONDATION 	8	45x96	150
VT5	MEZZANINE FLOOR JOISTS -HALBGESCHOSS BALKEN - SOLIVES DE PLANCHER MEZZANINE 	9	70x140	4245
VT6	MEZZANINE FLOOR JOISTS -HALBGESCHOSS BALKEN - SOLIVES DE PLANCHER MEZZANINE 	1	70x140	4245
VT2	MEZZANINE FLOOR JOISTS -HALBGESCHOSS BALKEN - SOLIVES DE PLANCHER MEZZANINE 	6	70x140	2895
VT1	MEZZANINE FLOOR JOISTS -HALBGESCHOSS BALKEN - SOLIVES DE PLANCHER MEZZANINE 	27	70x140	2895
VT11	MEZZANINE FLOOR JOISTS -HALBGESCHOSS BALKEN - SOLIVES DE PLANCHER MEZZANINE 	1	70x140	1580
VT4	MEZZANINE FLOOR JOISTS -HALBGESCHOSS BALKEN - SOLIVES DE PLANCHER MEZZANINE 	1	70x140	1280
VT3	MEZZANINE FLOOR JOISTS -HALBGESCHOSS BALKEN - SOLIVES DE PLANCHER MEZZANINE 	4	70x140	1175
VT12	MEZZANINE FLOOR JOISTS -HALBGESCHOSS BALKEN - SOLIVES DE PLANCHER MEZZANINE 	1	45x120	5540

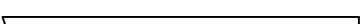



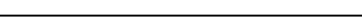

Pos	Mekong XL, Art.No.7012641 Piece list - Stückliste - Liste des pieces	Q.	P (mm)	L (mm)
VT14	MEZZANINE FLOOR JOISTS -HALBGESCHOSS BALKEN - SOLIVES DE PLANCHER MEZZANINE 	1	45x120	440
VT13	MEZZANINE FLOOR JOISTS -HALBGESCHOSS BALKEN - SOLIVES DE PLANCHER MEZZANINE 	1	45x96	5120
VT7	MEZZANINE FLOOR JOISTS -HALBGESCHOSS BALKEN - SOLIVES DE PLANCHER MEZZANINE 	4	45x96	3520
VT10	MEZZANINE FLOOR JOISTS -HALBGESCHOSS BALKEN - SOLIVES DE PLANCHER MEZZANINE 	3	45x96	3010
VT9	MEZZANINE FLOOR JOISTS -HALBGESCHOSS BALKEN - SOLIVES DE PLANCHER MEZZANINE 	3	45x96	2040
VT8	MEZZANINE FLOOR JOISTS -HALBGESCHOSS BALKEN - SOLIVES DE PLANCHER MEZZANINE 	3	45x96	1580
SR4	RAFTER - DACHSPARREN - CHEVRON 	14	70x170	4742
SR2	RAFTER - DACHSPARREN - CHEVRON 	36	70x170	3365
SR1	RAFTER - DACHSPARREN - CHEVRON 	10	70x170	3119
SR6	RAFTER - DACHSPARREN - CHEVRON 	1	70x170	1744
SR5	RAFTER - DACHSPARREN - CHEVRON 	1	70x170	1337
SR3	RAFTER - DACHSPARREN - CHEVRON 	6	70x170	204
STP	CEILING BOARDS - DECKENBRETTER - VOLIGES SOUS PLAFOND 	66	111x15	5116
STP	CEILING BOARDS - DECKENBRETTER - VOLIGES SOUS PLAFOND 	54	111x15	3516
STP	CEILING BOARDS - DECKENBRETTER - VOLIGES SOUS PLAFOND 	54	111x15	1576
PTL	FLOOR BOARDS - FUSSBODENBRETTER - LAME DE PLANCHER 	64	112x28	5116
PTL	FLOOR BOARDS - FUSSBODENBRETTER - LAME DE PLANCHER 	12	112x28	4906
PTL	FLOOR BOARDS - FUSSBODENBRETTER - LAME DE PLANCHER 	12	112x28	4696
PTL	FLOOR BOARDS - FUSSBODENBRETTER - LAME DE PLANCHER 	22	112x28	4241
PTL	FLOOR BOARDS - FUSSBODENBRETTER - LAME DE PLANCHER 	52	112x28	3516
PTL	FLOOR BOARDS - FUSSBODENBRETTER - LAME DE PLANCHER 	116	112x28	2891
PTL	FLOOR BOARDS - FUSSBODENBRETTER - LAME DE PLANCHER 	12	112x28	2511
PTL	FLOOR BOARDS - FUSSBODENBRETTER - LAME DE PLANCHER 	12	112x28	2300
PTL	FLOOR BOARDS - FUSSBODENBRETTER - LAME DE PLANCHER 	38	112x28	1576
	ROOF BOARDS - DACHBRETTER - VOLIGES 	76	90x18	5595

Pos	Mekong XL, Art.No.7012641 Piece list - Stückliste - Liste des pieces	Q.	P (mm)	L (mm)
	ROOF BOARDS - DACHBRETTER - VOLIGES 	15	90x18	5540
	ROOF BOARDS - DACHBRETTER - VOLIGES 	76	90x18	5505
	ROOF BOARDS - DACHBRETTER - VOLIGES 	15	90x18	4333
	ROOF BOARDS - DACHBRETTER - VOLIGES 	20	90x18	4123
	ROOF BOARDS - DACHBRETTER - VOLIGES 	20	90x18	1787
	ROOF BOARDS - DACHBRETTER - VOLIGES 	15	90x18	1527
SV2	TERRACE BOARDS - TERRASSENBRETTER - PLANCHER DE TERRASSE 	11	120x28	5240
SV2	TERRACE BOARDS - TERRASSENBRETTER - PLANCHER DE TERRASSE 	11	120x28	4577
SV2	TERRACE BOARDS - TERRASSENBRETTER - PLANCHER DE TERRASSE 	11	120x28	4554
SV2	TERRACE BOARDS - TERRASSENBRETTER - PLANCHER DE TERRASSE 	11	120x28	2869
SV2	TERRACE BOARDS - TERRASSENBRETTER - PLANCHER DE TERRASSE 	34	120x28	1500
LL	CEILING FILLET - DECKELEISTE - PROFIL DE FINITION POUR SOUS PLAFOND 		15x40	82 m.
	FLOOR FILLET-FUSSBODENLEISTE - CORNIERE DE FINITION DU PLANCHER 		15x40	
DPL	Kald-papiliist 	1	18x58	178
DPL	Kald-papiliist 	1	18x58	14258m.
DPL	Kald-papiliist 	1	18x58	5340
KLS	COVERING BOARD - DECKENLEISTEN - PROFILS DE FINITION 	2	18x70	2060
DPL	ROOFING FELT FILLET - DACHPAPPENLEISTE - BAGUETTE DE FIXATION DU FEUTRE BITUMEUX 	2	18x58	1470
DPL	ROOFING FELT FILLET - DACHPAPPENLEISTE - BAGUETTE DE FIXATION DU FEUTRE BITUMEUX 	1	18x58	1805
DPL	ROOFING FELT FILLET - DACHPAPPENLEISTE - BAGUETTE DE FIXATION DU FEUTRE BITUMEUX 	1	18x58	1816
DPL	ROOFING FELT FILLET - DACHPAPPENLEISTE - BAGUETTE DE FIXATION DU FEUTRE BITUMEUX 	1	18x58	3210
DPL	ROOFING FELT FILLET - DACHPAPPENLEISTE - BAGUETTE DE FIXATION DU FEUTRE BITUMEUX 	3	18x58	3437
DPL	ROOFING FELT FILLET - DACHPAPPENLEISTE - BAGUETTE DE FIXATION DU FEUTRE BITUMEUX 	2	18x58	4813
M12	TREADED ROD M12 - GEWINDESTANGE M12 - TIGE FILETÉE M12 	2		180
M12	TREADED ROD M12 - GEWINDESTANGE M12 - TIGE FILETÉE M12 	4		450

Pos	Mekong XL, Art.No.7012641 Piece list - Stückliste - Liste des pieces	Q.	P (mm)	L (mm)
M12	TREADED ROD M12 - GEWINDESTANGE M12  TIGE FILETÉE M12	12		2000
LPL	FIXING FILLET - FIXIRUNGSLEISTE - PROFIL DE FIXATION 	22	20x70	610
LPL	FIXING FILLET - FIXIRUNGSLEISTE - PROFIL DE FIXATION 	8	20x70	650
LPL	FIXING FILLET - FIXIRUNGSLEISTE - PROFIL DE FIXATION 	8	20x70	787
LPL	FIXING FILLET - FIXIRUNGSLEISTE - PROFIL DE FIXATION 	6	20x70	876
LPL	FIXING FILLET - FIXIRUNGSLEISTE - PROFIL DE FIXATION 	10	20x70	916
LPL	FIXING FILLET - FIXIRUNGSLEISTE - PROFIL DE FIXATION 	6	20x70	1060
LPL	FIXING FILLET - FIXIRUNGSLEISTE - PROFIL DE FIXATION 	4	20x70	1334
LPL	FIXING FILLET - FIXIRUNGSLEISTE - PROFIL DE FIXATION 	2	20x70	1540
LPL	FIXING FILLET - FIXIRUNGSLEISTE - PROFIL DE FIXATION 	6	20x70	1729
LPL	FIXING FILLET - FIXIRUNGSLEISTE - PROFIL DE FIXATION 	14	20x70	1760
LPL	FIXING FILLET - FIXIRUNGSLEISTE - PROFIL DE FIXATION 	20	20x70	2000
P	POST - PFOSTEN - POTEAU 	2	120x120	1700
TB	EAVES BOARD - TRAUFBRETT - BANDEAU DE TOIT 	1	18x120	200
TB	EAVES BOARD - TRAUFBRETT - BANDEAU DE TOIT 	1	18x120	218
TB	EAVES BOARD - TRAUFBRETT - BANDEAU DE TOIT 	1	18x120	3211
TB	EAVES BOARD - TRAUFBRETT - BANDEAU DE TOIT 	1	18x120	3855
TB	EAVES BOARD - TRAUFBRETT - BANDEAU DE TOIT 	1	18x120	4034
TB	EAVES BOARD - TRAUFBRETT - BANDEAU DE TOIT 	2	18x120	5222
TB	EAVES BOARD - TRAUFBRETT - BANDEAU DE TOIT 	1	18x120	5860
TB	EAVES BOARD - TRAUFBRETT - BANDEAU DE TOIT 	2	18x120	5910
TB	EAVES BOARD - TRAUFBRETT - BANDEAU DE TOIT 	1	18x90	200
TB	EAVES BOARD - TRAUFBRETT - BANDEAU DE TOIT 	1	18x90	3211
TB	EAVES BOARD - TRAUFBRETT - BANDEAU DE TOIT 	1	18x90	3855
TB	EAVES BOARD - TRAUFBRETT - BANDEAU DE TOIT 	1	18x90	4034

Pos	Mekong XL, Art.No.7012641 Piece list - Stückliste - Liste des pieces	Q.	P (mm)	L (mm)
TB	EAVES BOARD - TRAUFBRETT - BANDEAU DE TOIT 	2	18x90	5222
TB	EAVES BOARD - TRAUFBRETT - BANDEAU DE TOIT 	1	18x90	5455
TB	EAVES BOARD - TRAUFBRETT - BANDEAU DE TOIT 	1	18x90	5645
TB	EAVES BOARD - TRAUFBRETT - BANDEAU DE TOIT 	2	18x90	5860
TB	EAVES BOARD - TRAUFBRETT - BANDEAU DE TOIT 	2	18x90	5910
TBE12	FIXING FILLET - FIXIRUNGSLEISTE - PROFIL DE FIXATION 	2	28x34	2100
TBE6	FIXING FILLET FOR WINDOW - FIXIRUNGSLEISTE FÜR FENSTER - PROFIL DE FIXATION DES FENETRES 	2	28x34	476
TBE6	FIXING FILLET FOR WINDOW - FIXIRUNGSLEISTE FÜR FENSTER - PROFIL DE FIXATION DES FENETRES 	20	28x34	650
TBE6	FIXING FILLET FOR WINDOW - FIXIRUNGSLEISTE FÜR FENSTER - PROFIL DE FIXATION DES FENETRES 	10	28x34	916
TBE6	FIXING FILLET FOR WINDOW - FIXIRUNGSLEISTE FÜR FENSTER - PROFIL DE FIXATION DES FENETRES 	6	28x34	1729
TBE6	FIXING FILLET FOR DOOR - FIXIRUNGSLEISTE FÜR TÜR - PROFIL DE FIXATION DES PORTES 	4	28x34	1836
TBE6	FIXING FILLET FOR DOOR - FIXIRUNGSLEISTE FÜR TÜR - PROFIL DE FIXATION DES PORTES 	16	28x34	2000
GL3	GABLE MOULDING - GIEBELLEISTE - PLANCHE DE RIVE 	1	18x90	1754
GL3	GABLE MOULDING - GIEBELLEISTE - PLANCHE DE RIVE 	1	18x90	1816
GL3	GABLE MOULDING - GIEBELLEISTE - PLANCHE DE RIVE 	1	18x90	3209
GL3	GABLE MOULDING - GIEBELLEISTE - PLANCHE DE RIVE 	3	18x90	3437
GL3	GABLE MOULDING - GIEBELLEISTE - PLANCHE DE RIVE 	1	18x90	4813
GL	GABLE MOULDING - GIEBELLEISTE - PLANCHE DE RIVE 	1	18x120	1409
GL	GABLE MOULDING - GIEBELLEISTE - PLANCHE DE RIVE 	1	18x120	1736
GL	GABLE MOULDING - GIEBELLEISTE - PLANCHE DE RIVE 	1	18x120	1798
GL	GABLE MOULDING - GIEBELLEISTE - PLANCHE DE RIVE 	1	18x120	1816
GL	GABLE MOULDING - GIEBELLEISTE - PLANCHE DE RIVE 	1	18x120	3192
GL	GABLE MOULDING - GIEBELLEISTE - PLANCHE DE RIVE 	1	18x120	3231
GL	GABLE MOULDING - GIEBELLEISTE - PLANCHE DE RIVE 	3	18x120	3419
GL	GABLE MOULDING - GIEBELLEISTE - PLANCHE DE RIVE 	3	18x120	3437

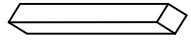
Pos	Mekong XL, Art.No.7012641 Piece list - Stückliste - Liste des pieces	Q.	P (mm)	L (mm)
GL	GABLE MOULDING - GIEBELLEISTE - PLANCHE DE RIVE 	3	18x120	4795
GL	GABLE MOULDING - GIEBELLEISTE - PLANCHE DE RIVE 	3	18x120	4813
KL4	LENGTHENING BOLT FOR TREADED ROD - VERLÄNGERUNGSMUTTER FÜR GEWINDESTANGE - MANCHON DE RACCORDEMENT DE TIGE FILETÉE 	12		
KL1	DRIVE NUT TREADED ROD - EINSHLAGMUTTER FÜR GEWINDESTANGE - ÉCROU A FRAPPER POUR TIGE FILITÉE 	6		
KL2	NUT FOR TREADED ROD - MUTTER FÜR GEWINDESTANGE - ÉCROU POUR TIGE FILETÉE 	6		
KL3	PLAIN WASHER TREADED ROD - UNTERLEGSSCHEIBE FÜR GEWINDESTANGE - RONDELLE PLATE POUR TIGE FILETÉE 	6		
HS12	SCREW FOR GABLE SEGMENT - SCHRAUBEN FÜR DECKBLATT - VIS POUR FIXATION LOSANGE DE FINITION 	4	3.5x35	
HS11	SCREW FOR COVERING BOARDS - SCHRAUBEN FÜR DECKLEISTEN - VIS POUR FIXATION PROFILS DE FINITION 	10	3.5x50	
HS83	SCREW FOR FIXING FILLET - SCHRAUBEN FÜR FIXIRUNGSLEISTE - VIS POUR PROFIL DE FIXATION 	408	3.5x50	
HS32	SCREW FOR EAVES BOARDS - SCHRAUBEN FÜR TRAUFBRETTEN - VIS DE FIXATION POUR BANDEAU DE TOIT 	190	3.5x50	
HS84	SCREW FOR FIXING FILLET - SCHRAUBEN FÜR FIXIRUNGSLEISTE - VIS POUR PROFIL DE FIXATION 	248	3.5x50	
HS16	SCREW FOR GABLE MOULDING - SCHRAUBEN FÜR GIEBELLEISTE - VIS DE FIXATION POUR PLANCHE DE RIVE 	192	3.5x50	
NFD	SCREW FOR ROOFING FELT FILLET - SCHRAUBEN FÜR DACHPAPPENLEISTE - VIS POUR BAGUETTE FIXATION FEUTRE BITUMEUX 	87	4x40	
HS73	SCREW FOR CONNECTING PLATE - SCHRAUBE FÜR ANSCHLUSSPLATTE - VIS DE FIXATION DES PLAQUES DE CONNEXION 	200	4x40	
HS34	SCREW FOR POST - SCHRAUBEN FÜR PFOSTEN - VIS DE FIXATION DES POTEAUX 	4	4x60	
HS75	SCREW FOR RAFTER - SCHRAUBEN ZUR BEFESTIGUNG DACHSPARREN - VIS POUR CHEVRON 	16	5x100	
HS86	SCREW FOR MEZZANINE FLOOR JOISTS - SCHRAUBEN FÜR HALBGESCHOSS BALKEN - VIS DE FIXATION SOLIVES DE PLANCHER MEZZANINE 	150	5x100	
HS39	SCREW FOR FUNDAMENT - SCHRAUBEN ZUR BEFESTIGUNG FUNDAMENT - VIS POUR FONDATION 	322	5x90	
HS48	SCREW FOR Pos.008; 019-021; 053 - SCHRAUBEN FÜR Pos.008; 019-021; 053 VIS POUR Pos.008; 019-021; 053 	316	6x180	
HS49	SCREW FOR POST HEIGHT ADJUSTMENT - SCHRAUBEN FÜR REGULIERUNGSSCHRAUBE FÜR PFOSTEN - VIS DE FIXATION DE SUPPORT RÉGLABLE DE POTEAU 	16	6x50	
HS44	SCREW FOR RAFTER - SCHRAUBEN ZUR BEFESTIGUNG DACHSPARREN VIS POUR CHEVRON 	122	8x220	
MS	SCREW FOR DOORSTEP - SCHRAUBEN FÜR TÜRSCHWELLE - VIS DE FIXATION DU SEUIL DE PORTE 	12	4.5x65	
SH70	HAMMER BLOCK - SCHLAGHOLZ - CALLE DE FRAPPE 	4		
NFC	ZN NAIL FOR CEILING FILLETS - ZN NÄGEL FÜR DECKENLEISTEN - POINTE POUR CORNIERE 	164	1.4x40	
NFF	ZN NAIL FOR FLOOR FILLETS - ZN NÄGEL FÜR FUSSBODENLEISTEN - POINTE POUR PANNEAUX DE PLANCHER 	2520	1.4x40	

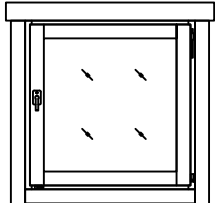
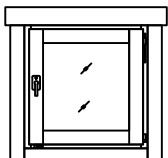
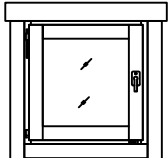
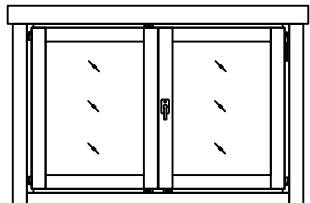
Pos	Mekong XL, Art.No.7012641 Piece list - Stückliste - Liste des pieces	Q.	P (mm)	L (mm)
NF2	ZN NAIL FOR ROOF - ZN NÄGEL FÜR DACHBRETTER - POINTE POUR TOIT 	2610	2x50	
NF2	ZN NAIL FOR CEILING BOARDS - ZN NÄGEL FÜR DECKENBRETTER - CLOUS POUR VOLIGES SOUS PLAFONDS 	1350	2x50	
NH1	ZN NAIL FOR FLOOR - ZN NÄGEL FÜR FUSSBODENBRETTER - CLOUS POUR PLANCHER 	2520	2x50	
KR2	CONNECTING PLATE - ANSCHLUSSPLATTE - PLAQUE MÉTALLIQUE DE CONNEXION 	25		
ORZ	MONTAGE SET FOR DOORS AND WINDOWS - MONTAGE-SET FÜR TÜREN UND FENSTER - JEU DE MONTAGE PORTES ET FENETRES	1		
GS	GABLE SEGMENT-DECKBLATT - LOSANGE DE FINITION 	2		
SP1	HIDDEN FIXING - HOLZDÜBEL - TOURILLON BOIS 	16		
TRL	STAIRCASE, U-SHAPED - TREPPE, FORM U - ESCALIER, FORME U	1		
RFP	POST HEIGHT ADJUSTMENT - REGULIERUNGSSCHRAUBE FÜR PFOSTEN - SUPPORT RÉGLABLE DE POTEAU 	2		
2+ A.OP	WINDOW-FENSTER-FENETRE 916x916 	3		
2+ A.OP.c	WINDOW-FENSTER-FENETRE 650x650 	3		
2+ A.OV.c	WINDOW-FENSTER-FENETRE 650x650 	1		
2+ T.A.OP	WINDOW-FENSTER-FENETRE 1374x916 	2		

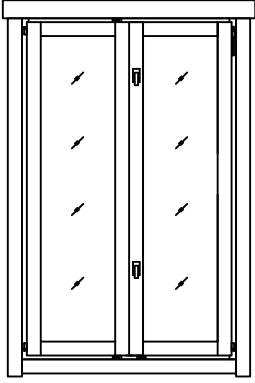
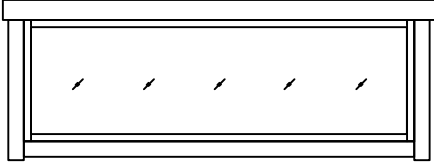
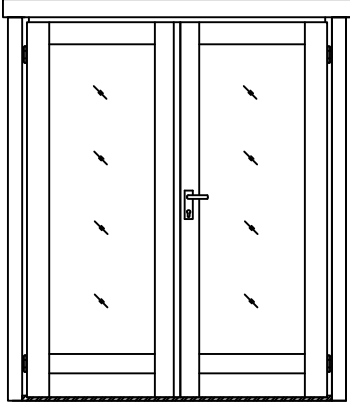
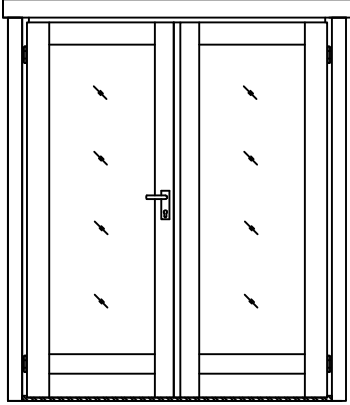
Pos	Mekong XL, Art.No.7012641 Piece list - Stückliste - Liste des pieces	Q.	P (mm)	L (mm)
2+ TA .0P.b	WINDOW-FENSTER-FENETRE 1100x1729 	3		
2+	WINDOW-FENSTER-FENETRE 1800x650 	7		
2+ TU .10P.b	DOOR-TÜR-PORTE 1580x2000 	1		
2+ TU .10V.b	DOOR-TÜR-PORTE 1580x2000 	1		

