

Ganges
Art.Nr. 702041

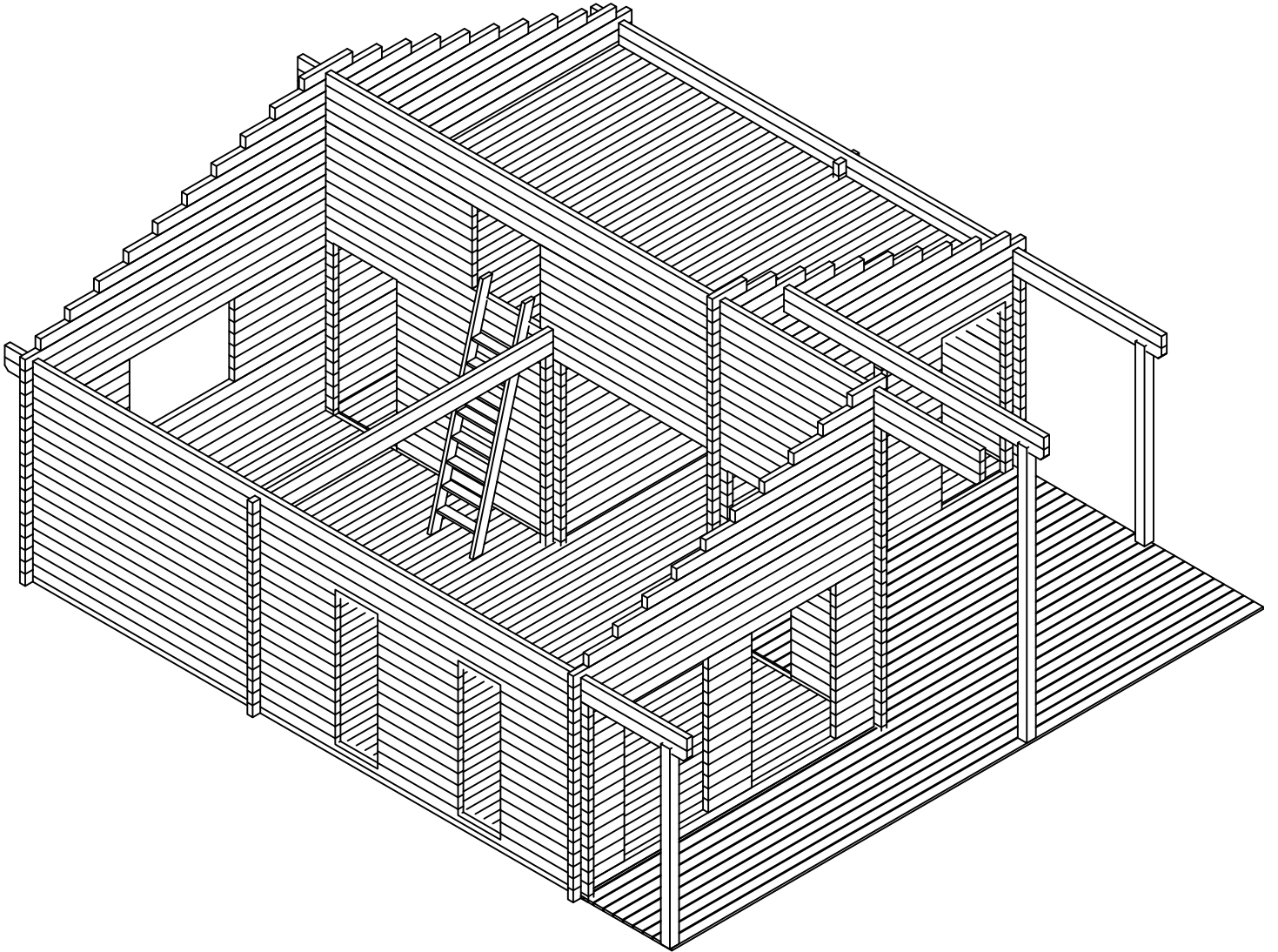

Ganges
Art.Nr. 702041

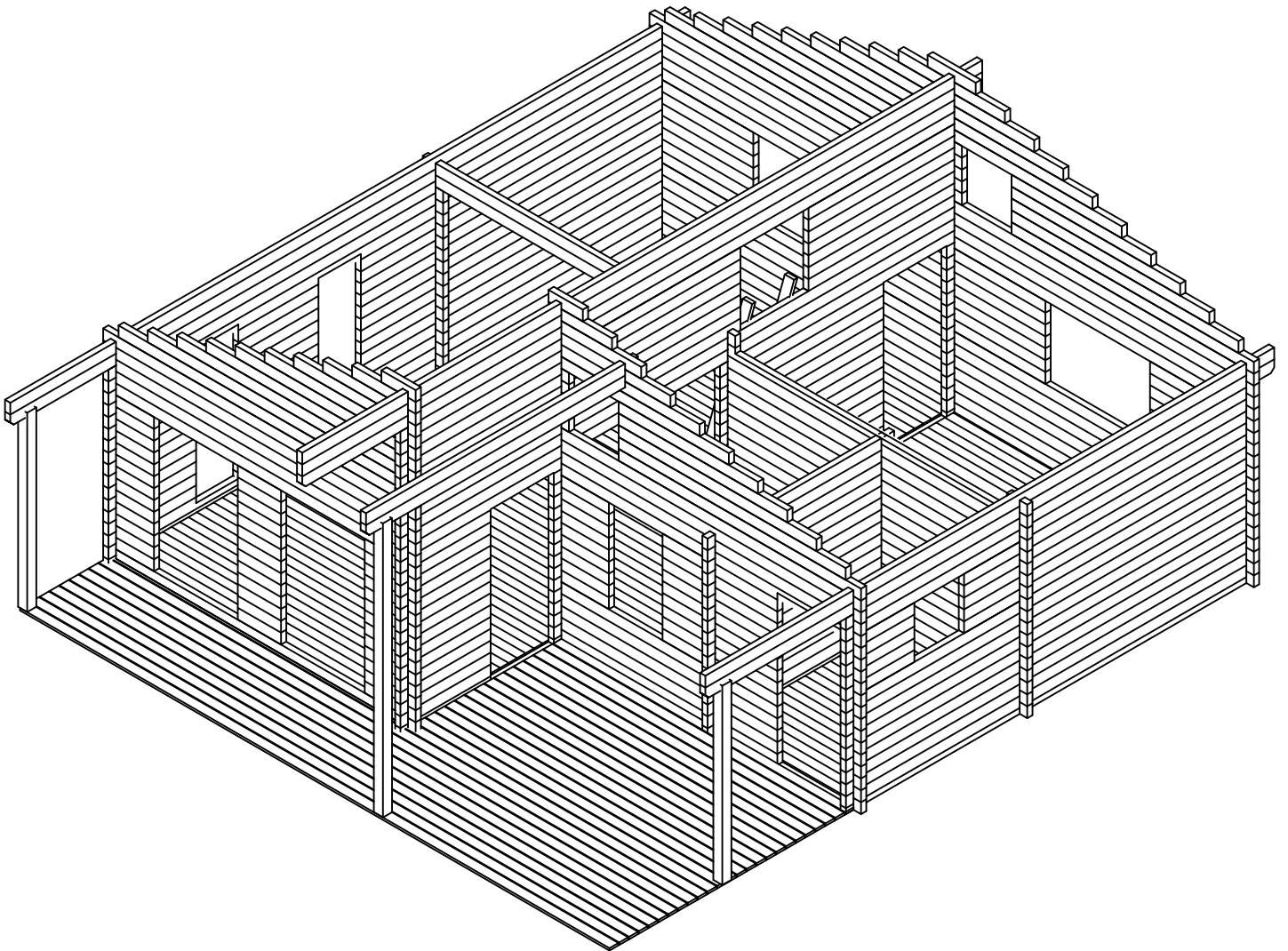

Ganges, Art.No.702041
 GROUNDPLAN GROUND FLOOR - GRUNDPLAN ERDGESCHOSS - PLAN DE MASSE REZ DE CHAUSSEE

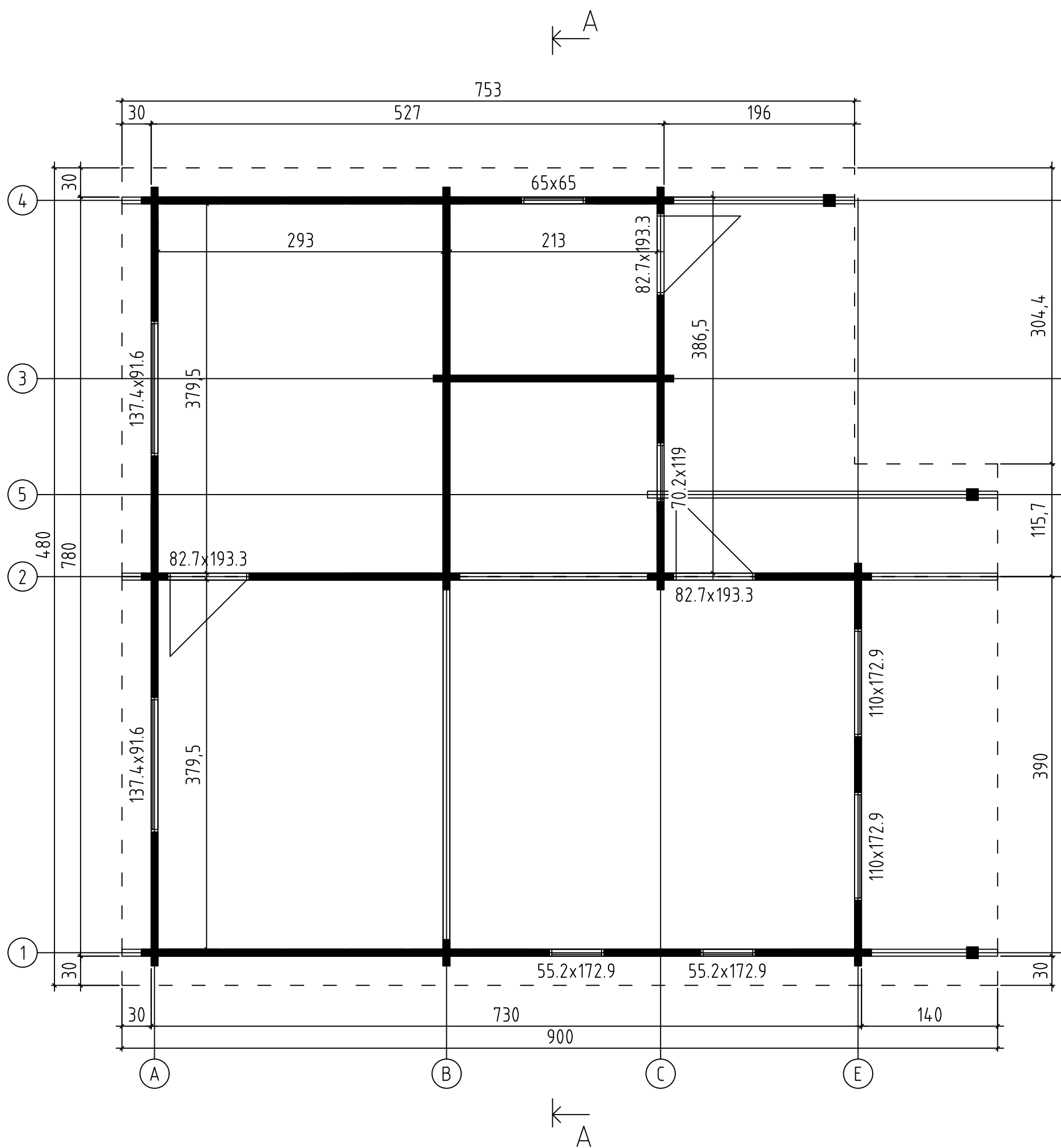

Ganges, Art.No.702041
GROUNDPLAN FIRST FLOOR - GRUNDPLAN ERSTE STOCK - PLAN DE MASSE PREMIER ETAGE

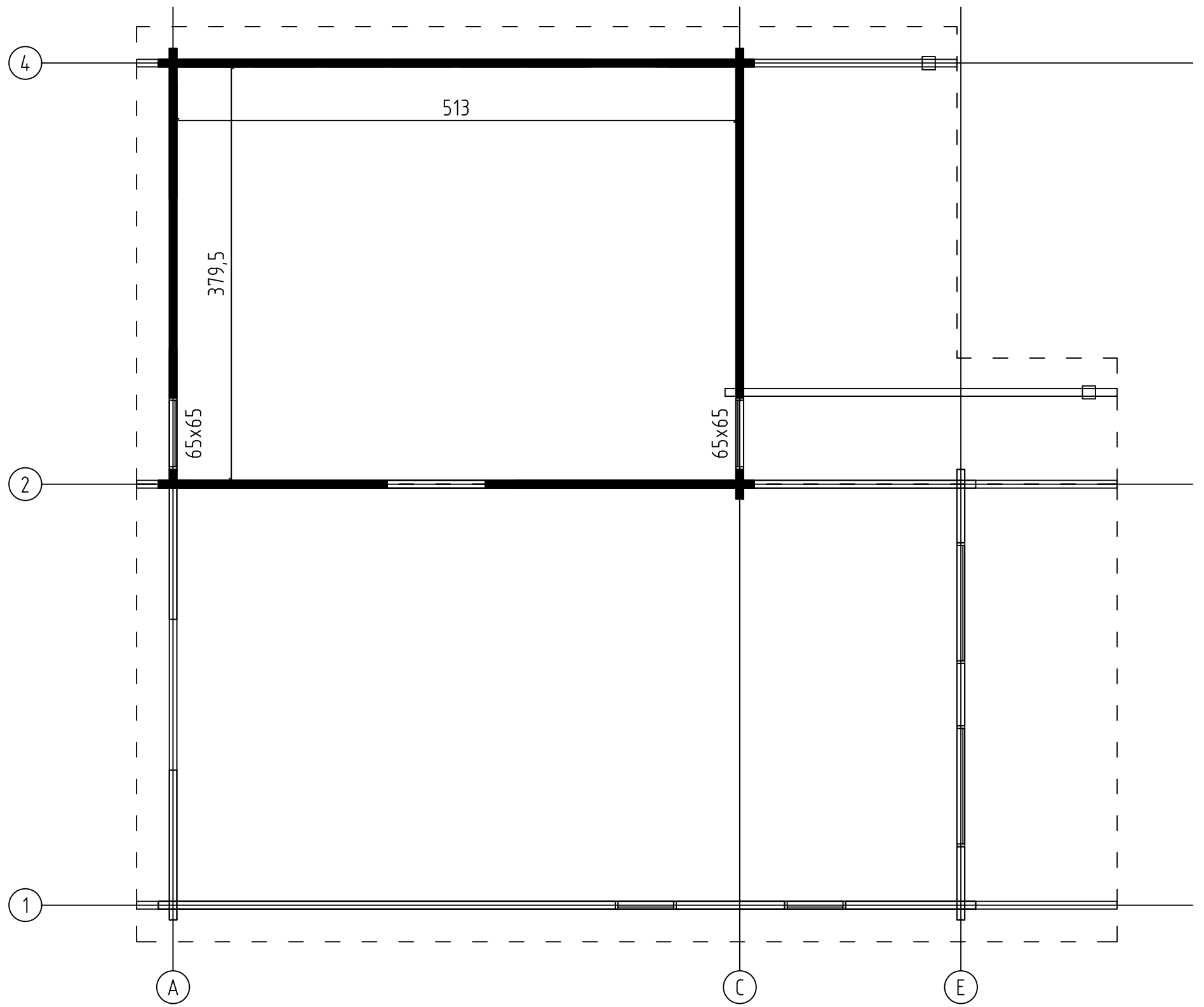

Ganges, Art.No.702041
FOUNDATION - FUNDAMENTBALKEN - FONDATION

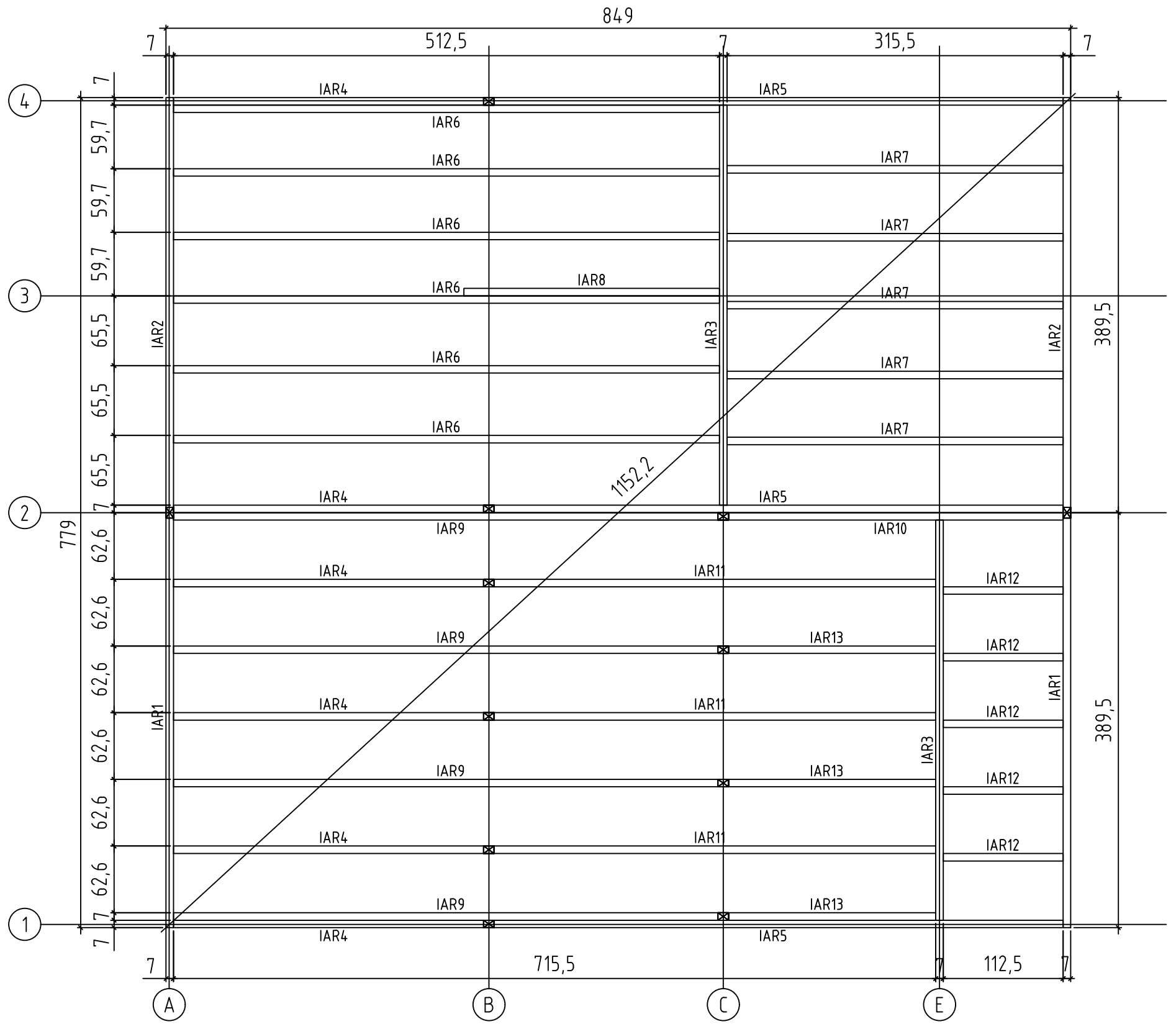

Ganges, Art.No.702041
RAFTERS PLAN - DACHSPARREN - PLAN DE CHEVRON

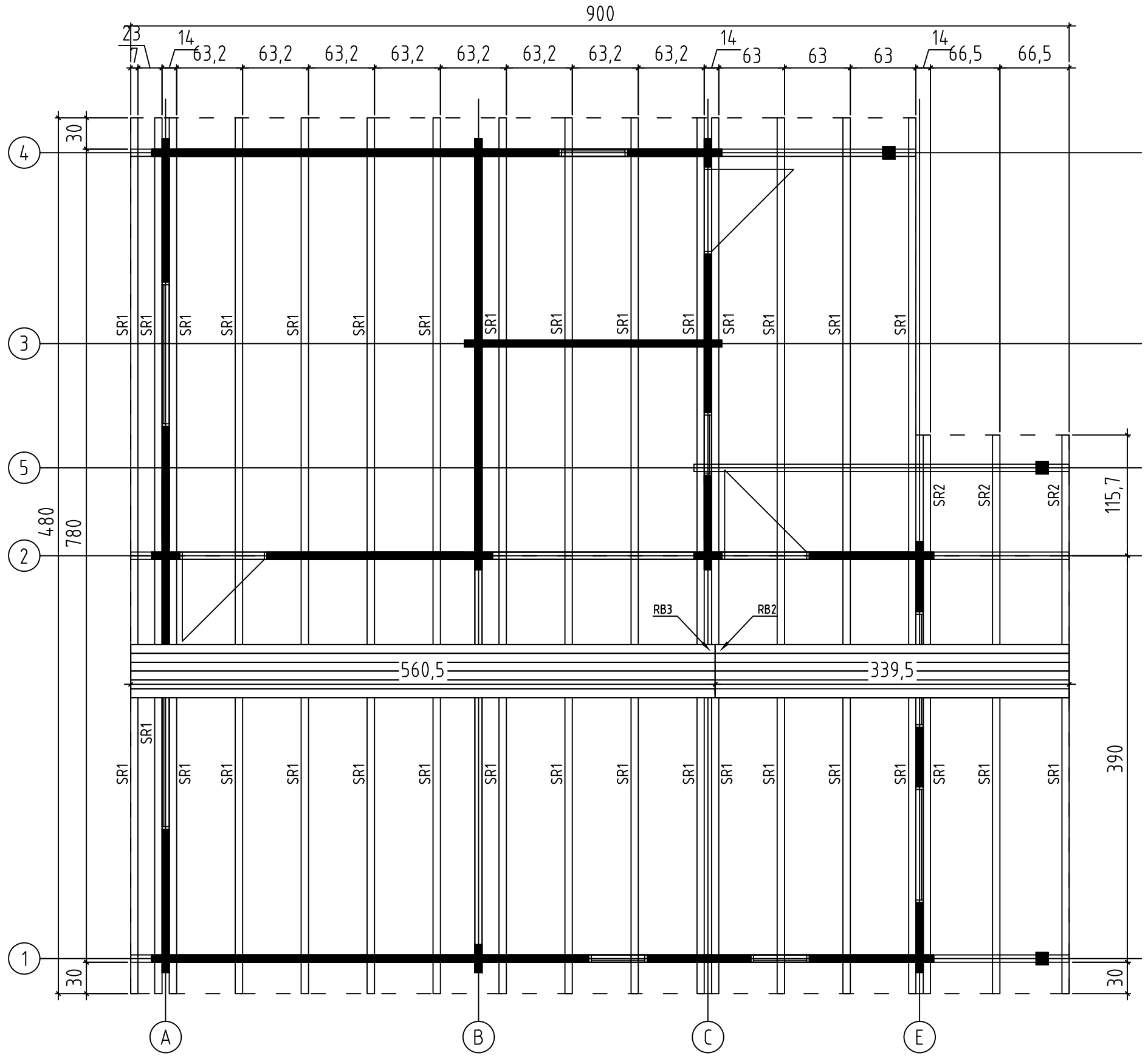

Ganges, Art.No.702041
CEILING BOARDS - DECKENBRETTER - VOLIGES SOUS PLAFOND

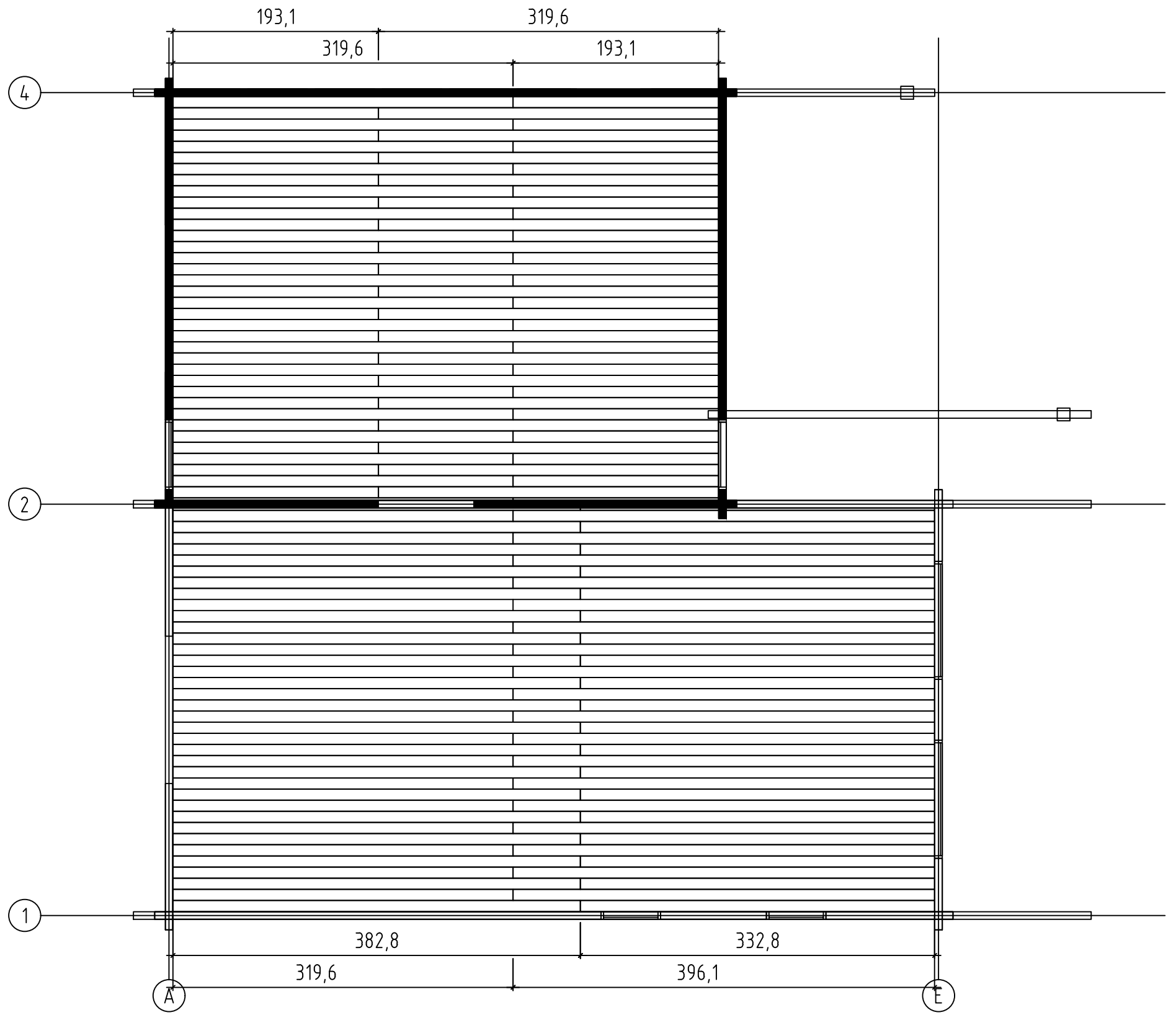

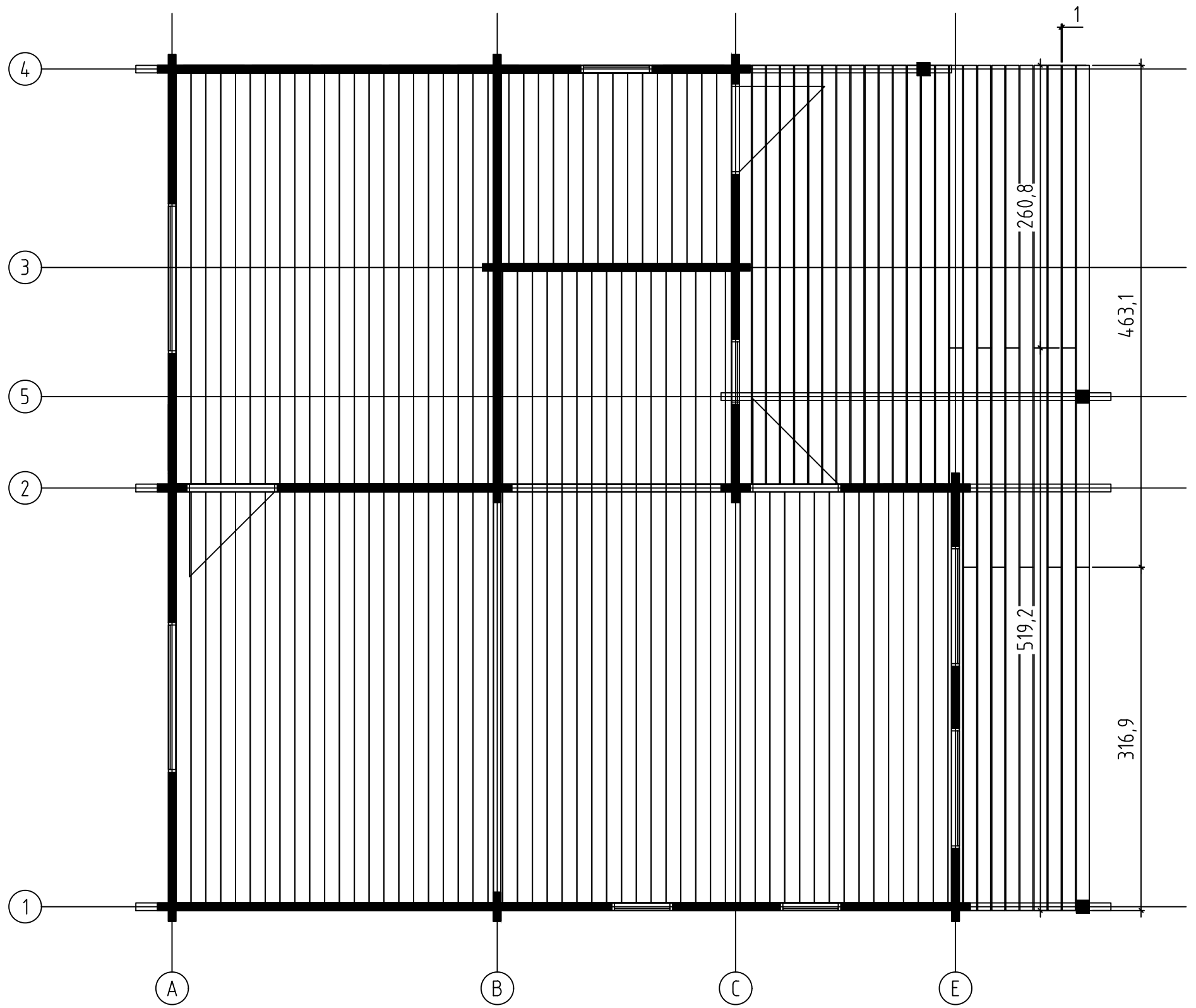

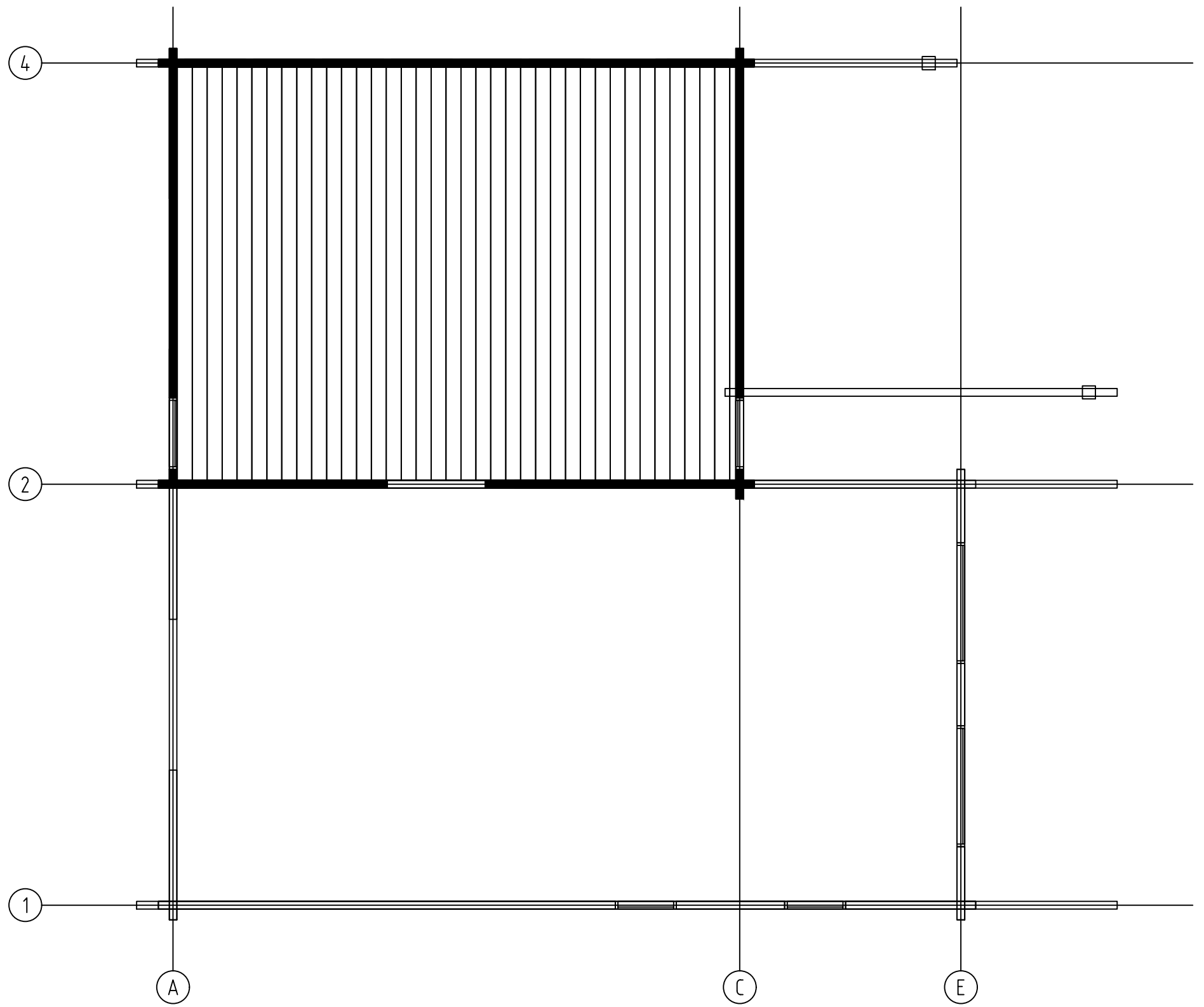

Ganges, Art.No.702041

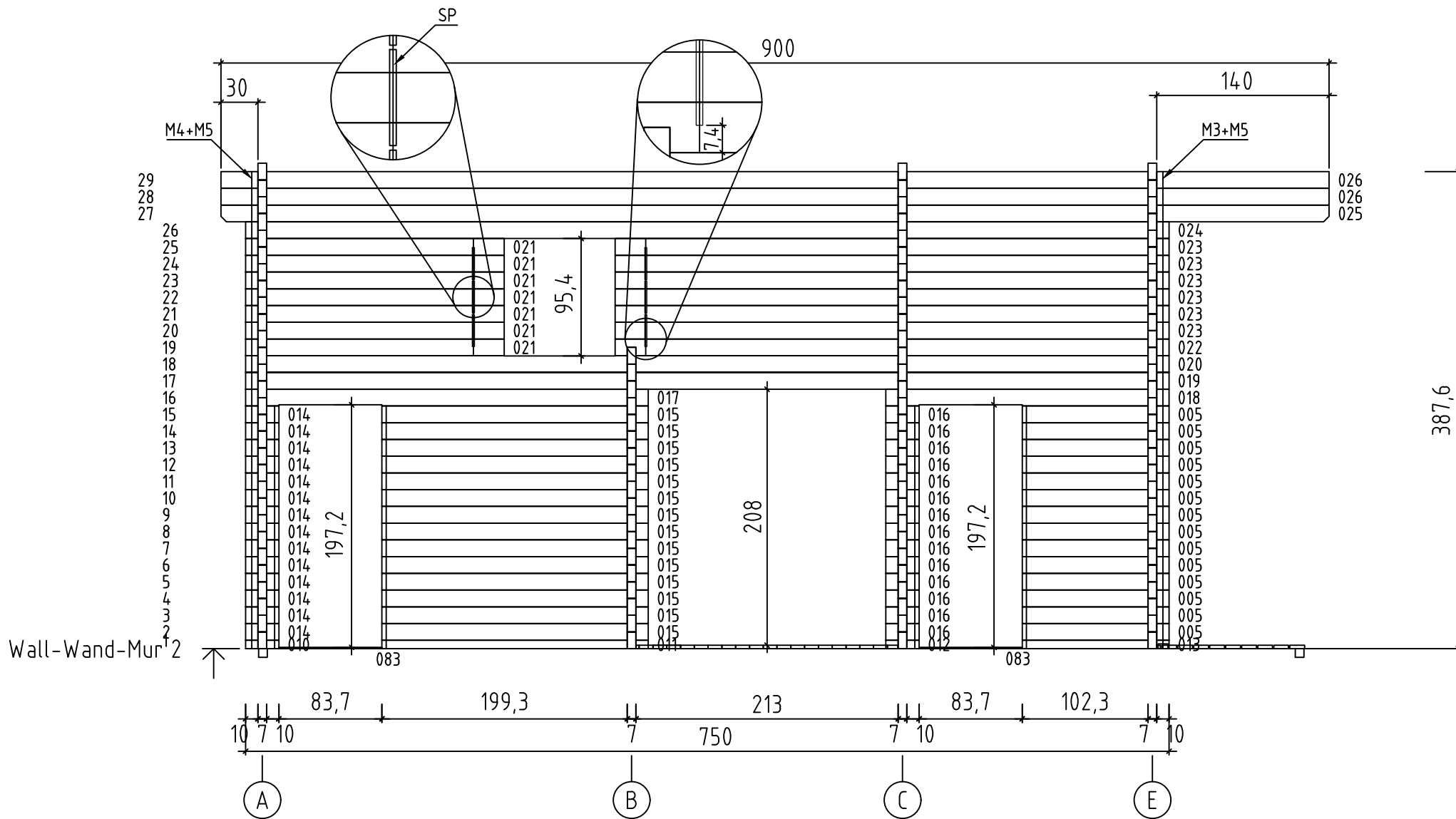

Ganges, Art.No.702041

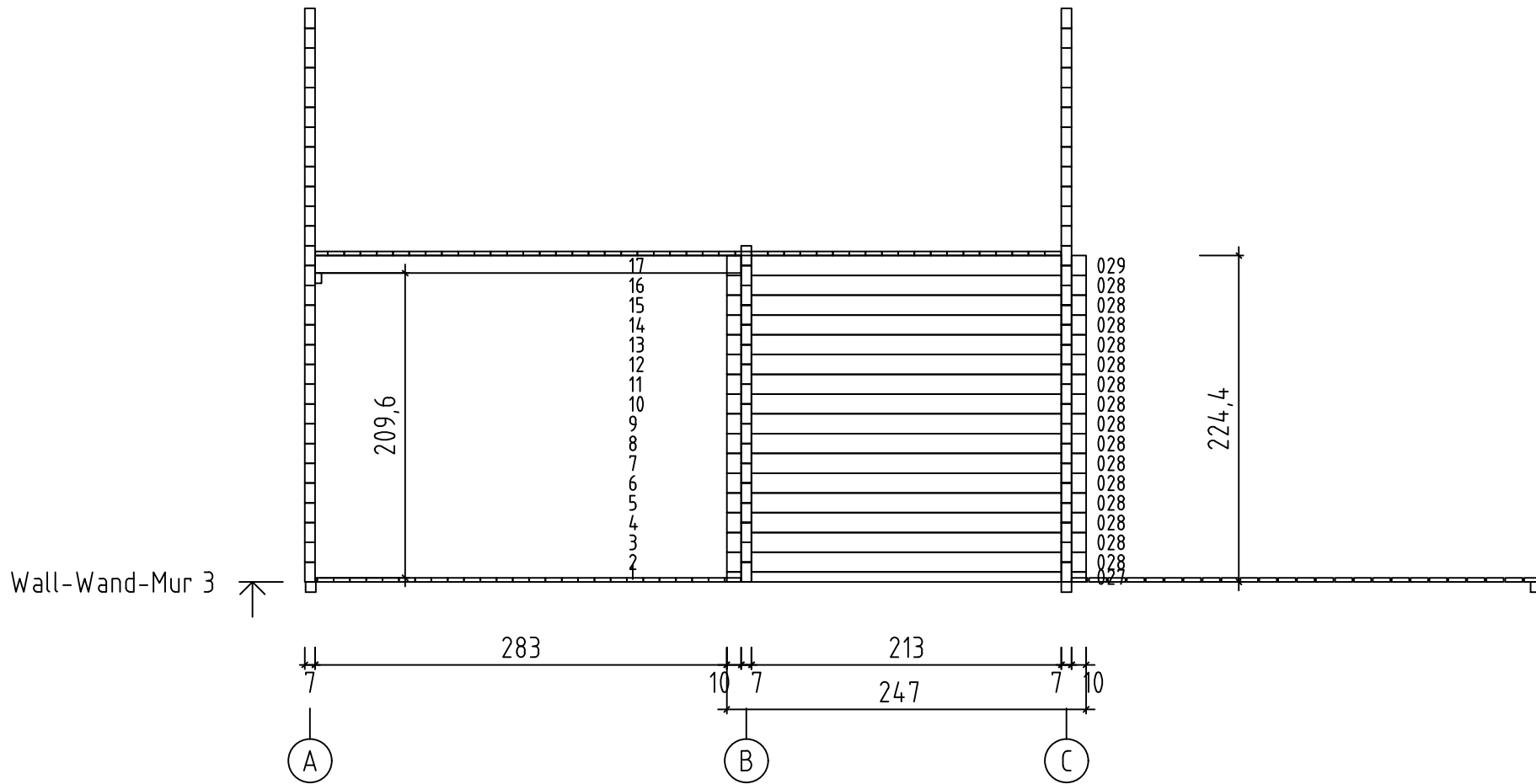

Ganges, Art.No.702041

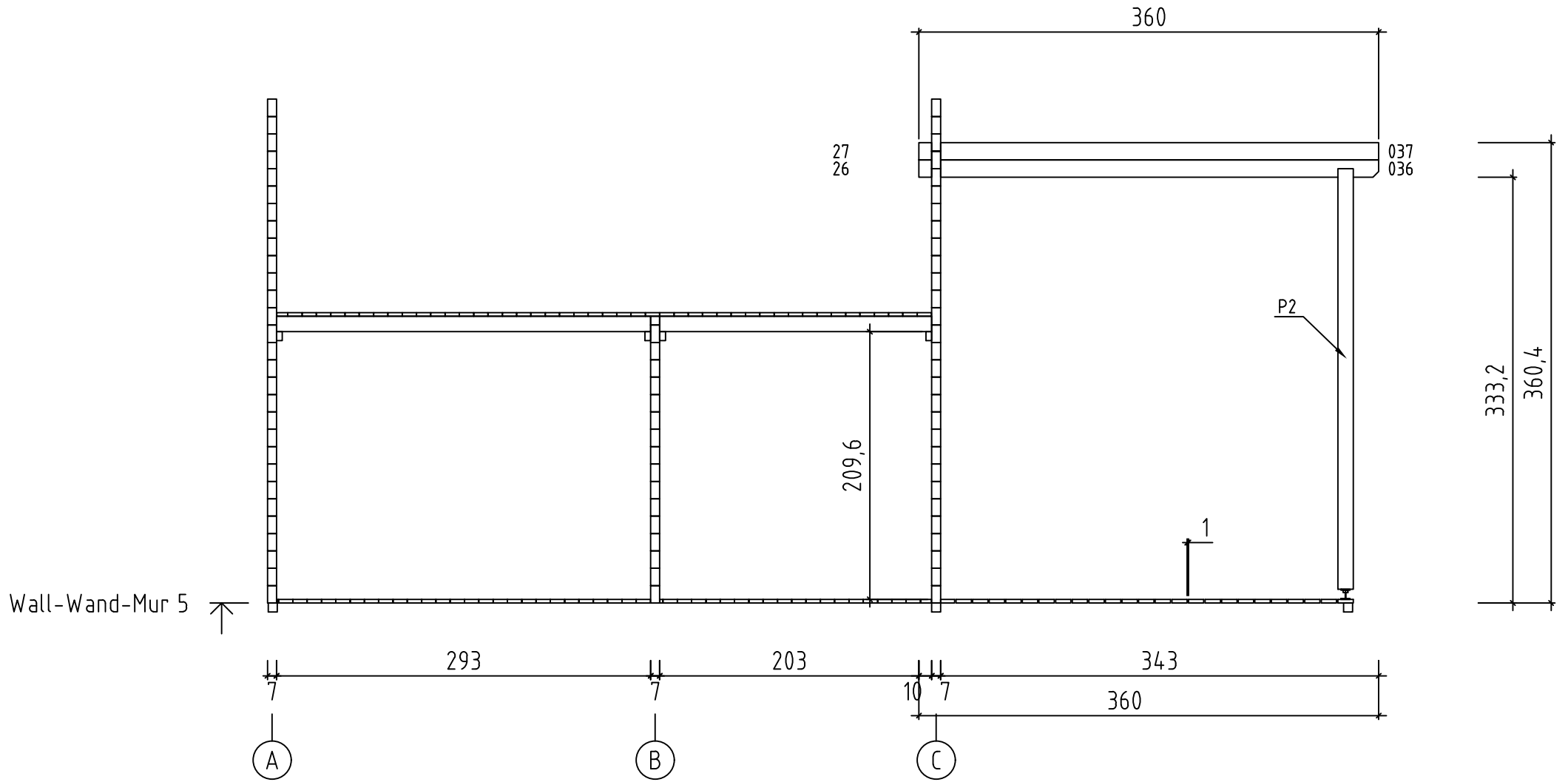

Ganges, Art.No.702041

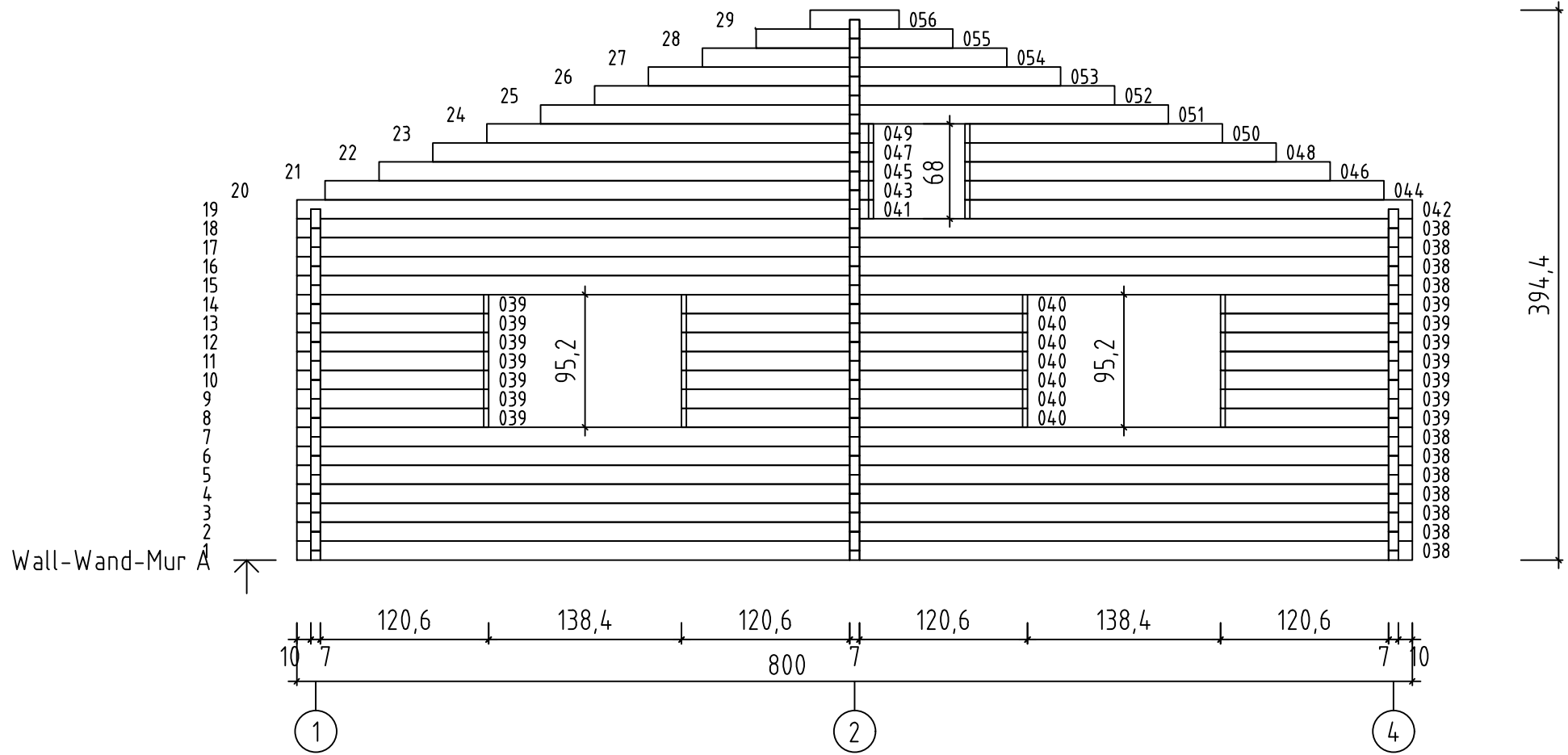

Ganges, Art.No.702041

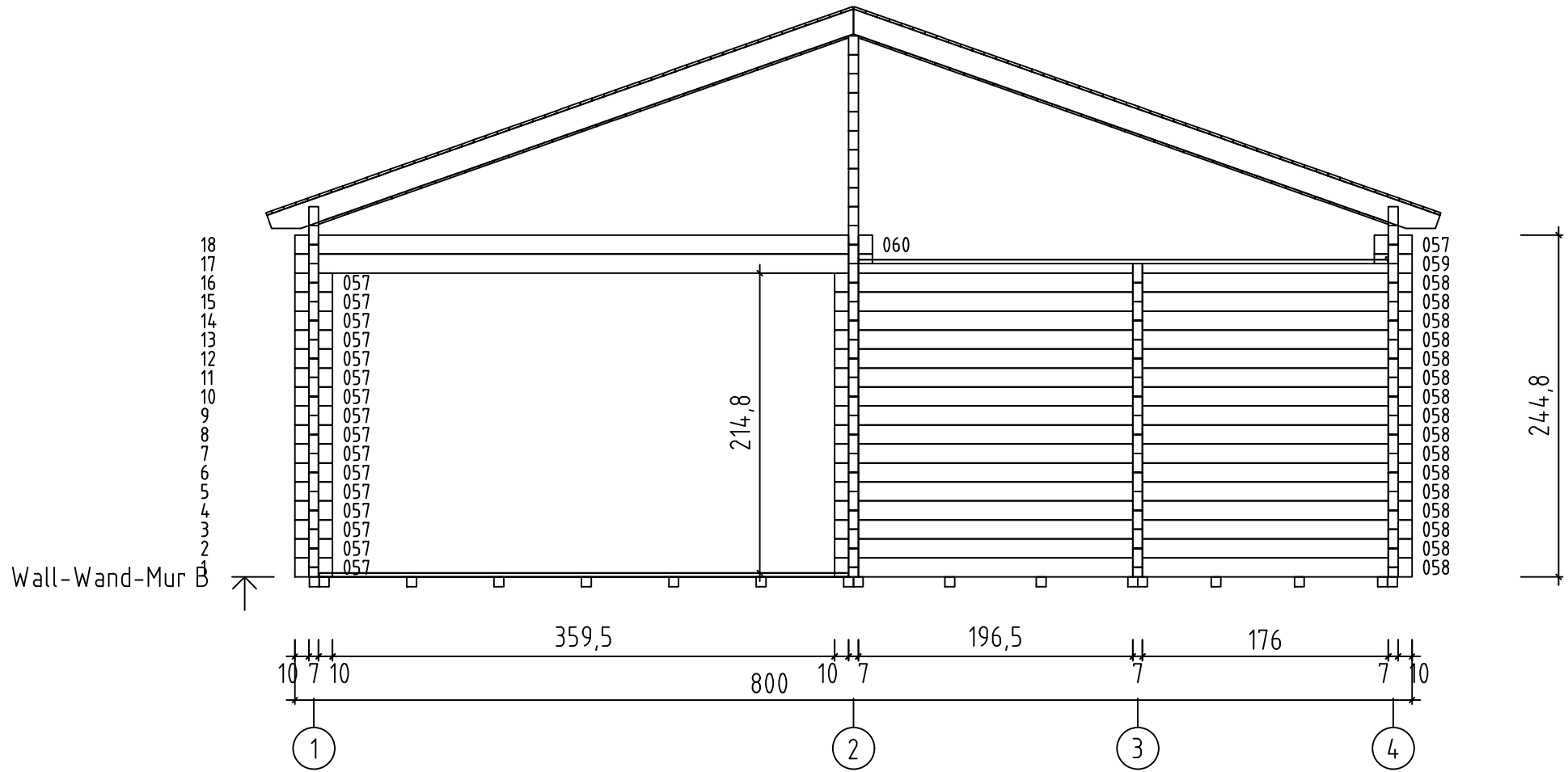

Ganges, Art.No.702041

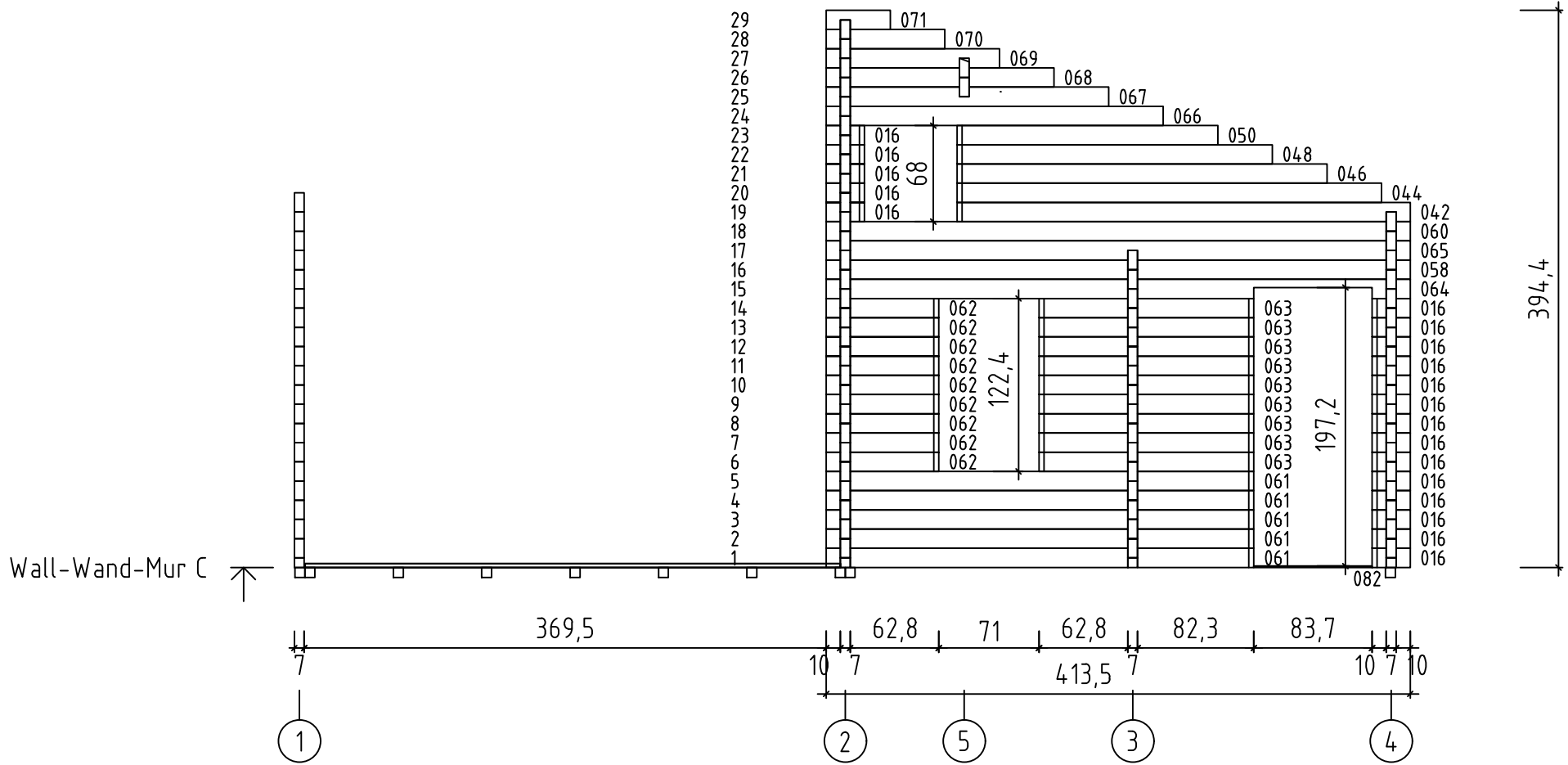



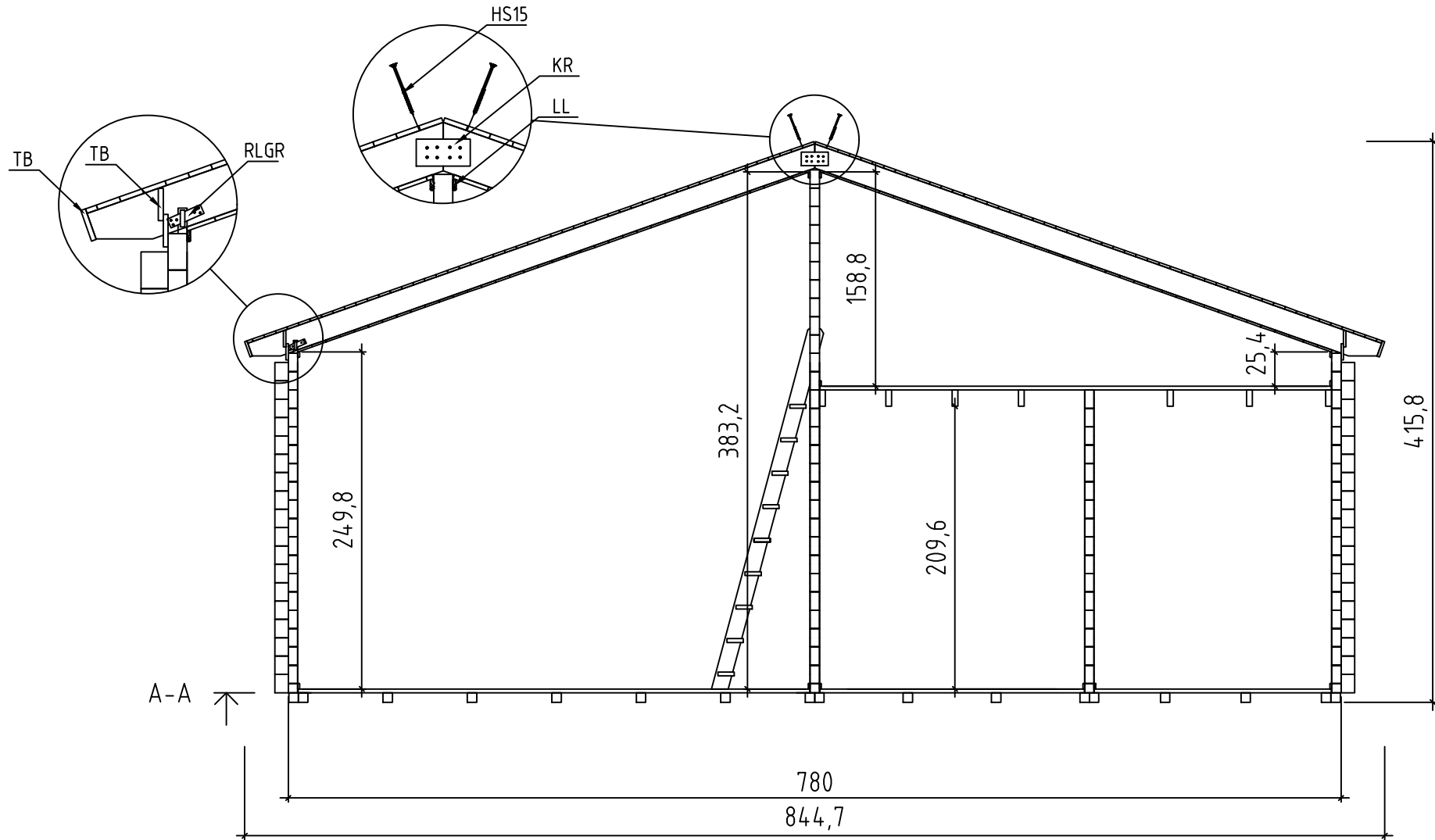

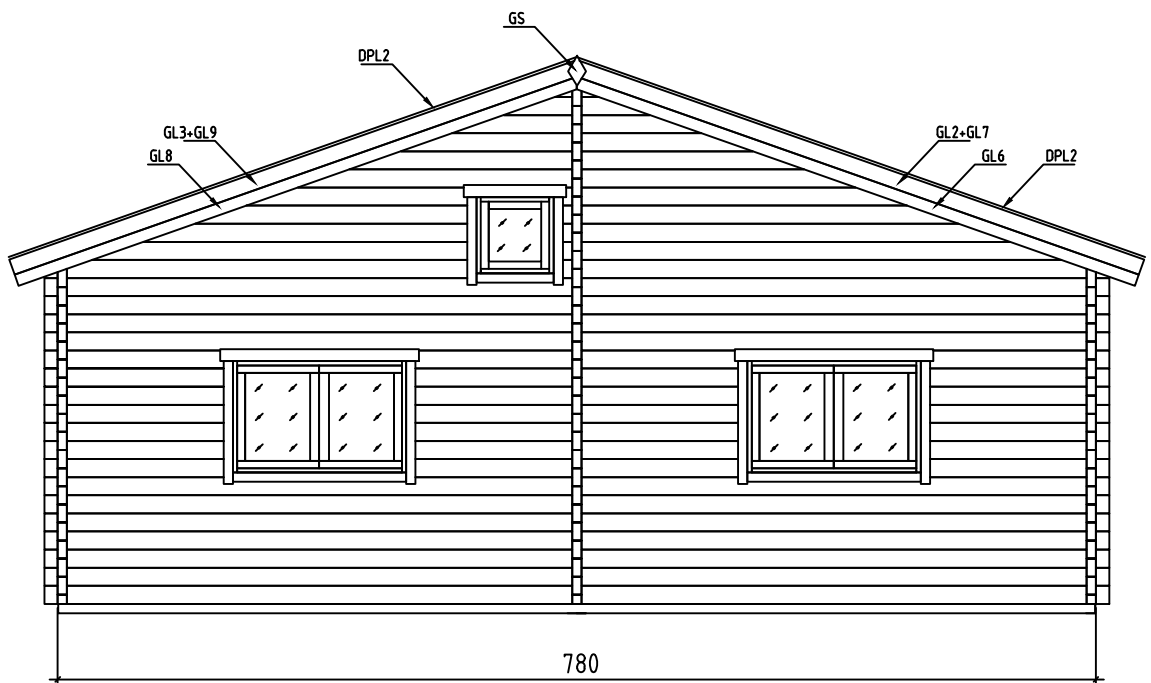
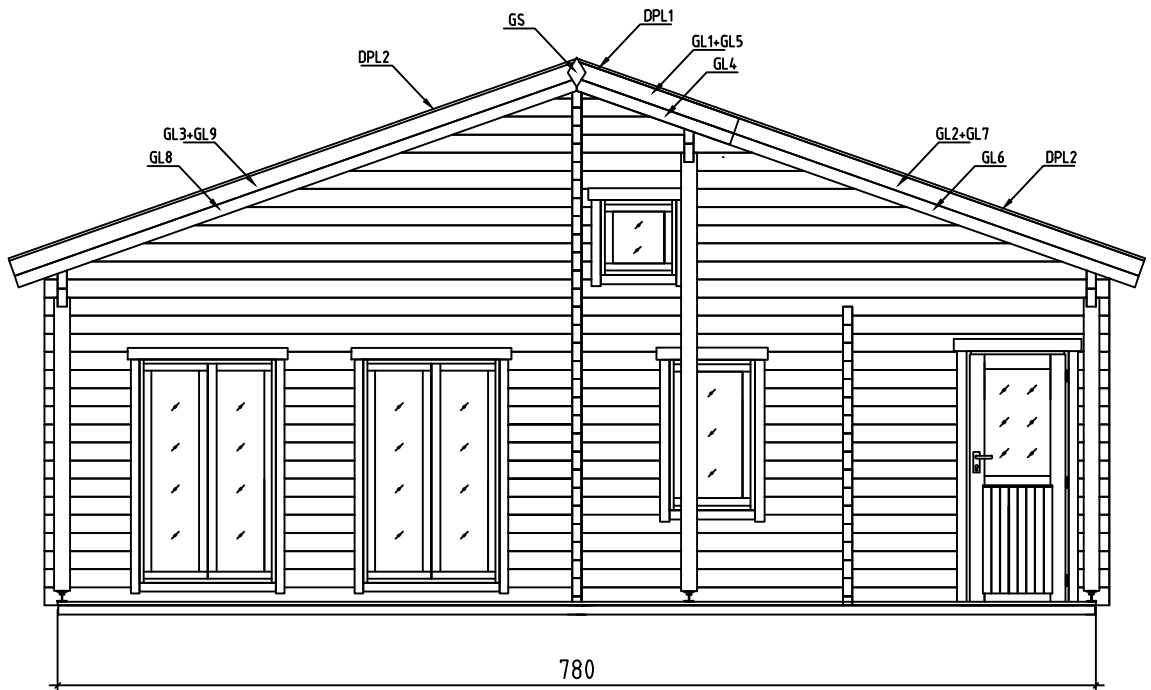

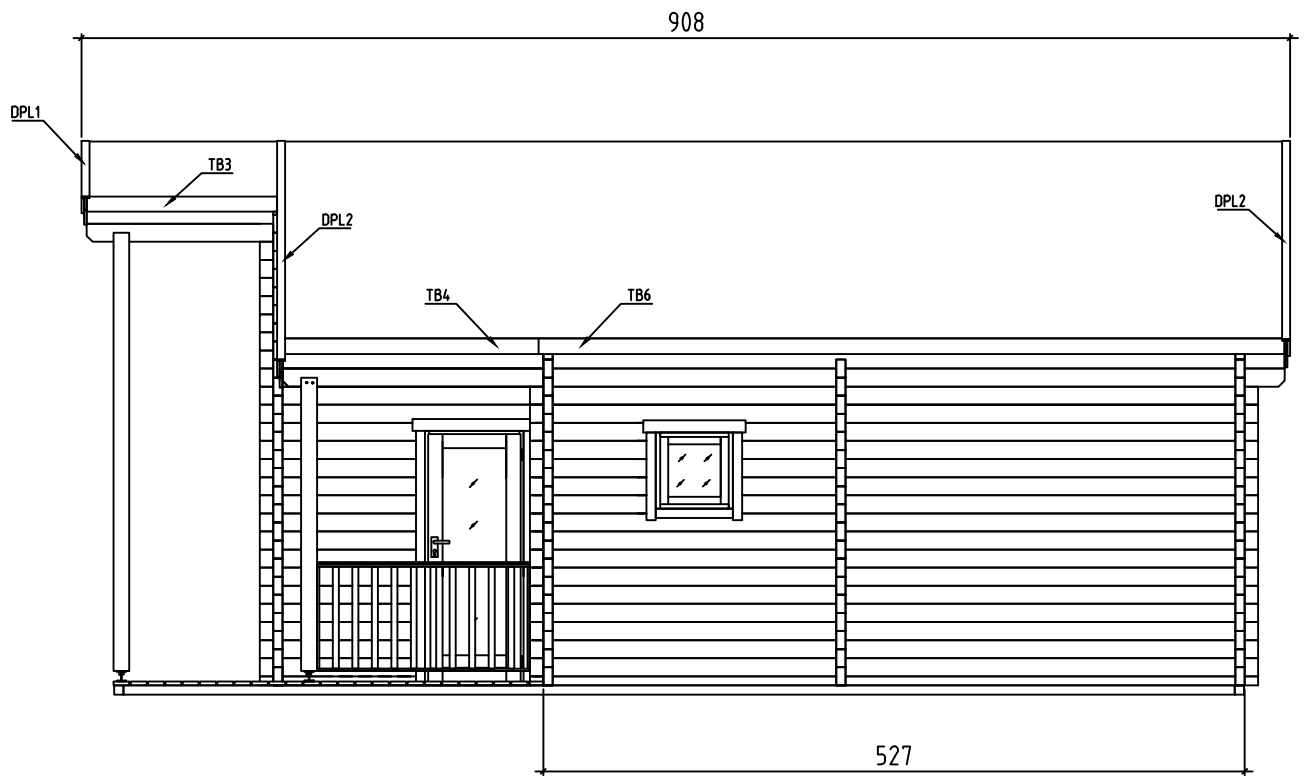
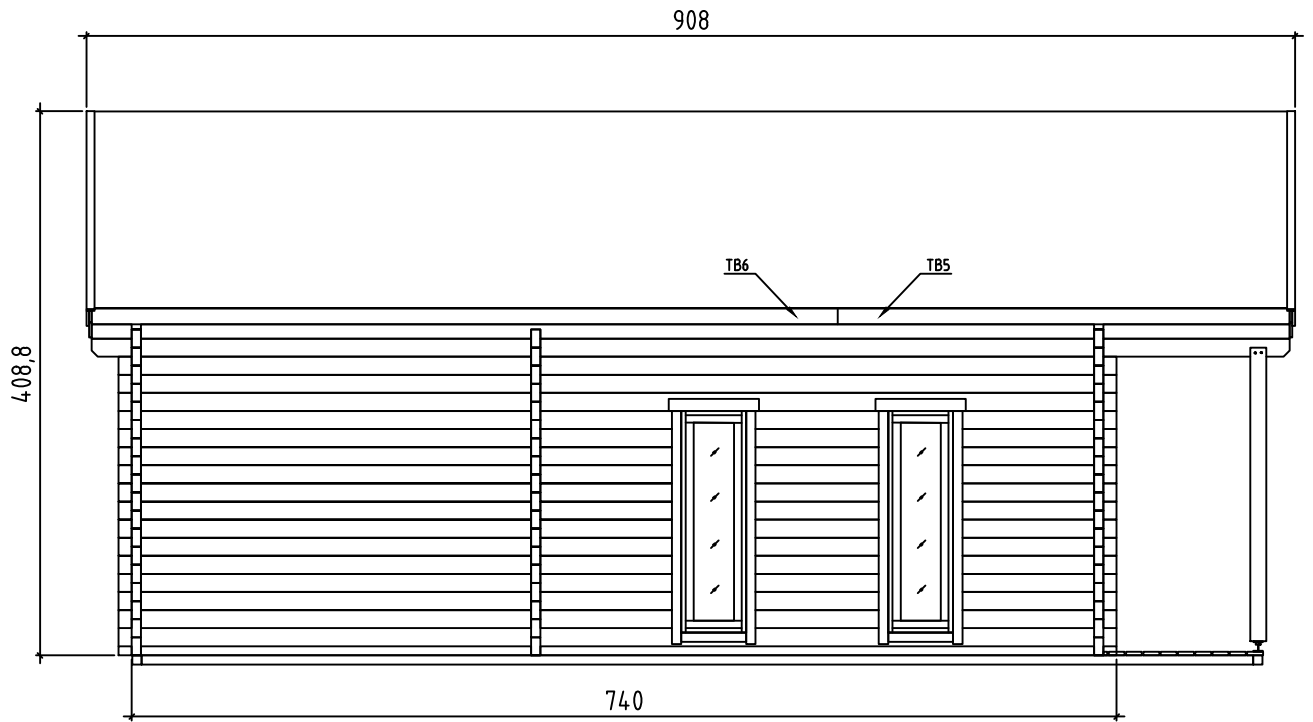

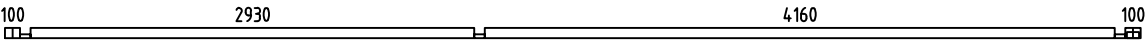
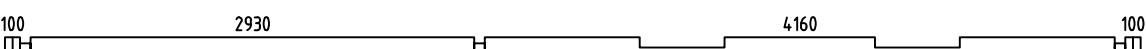
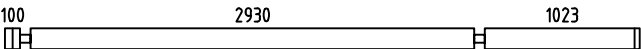
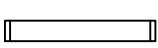
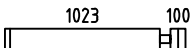
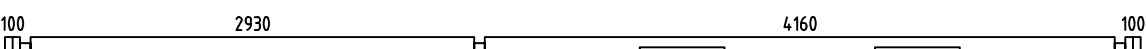

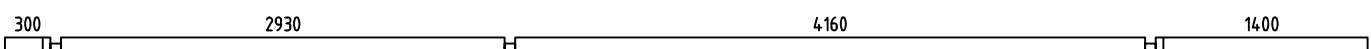
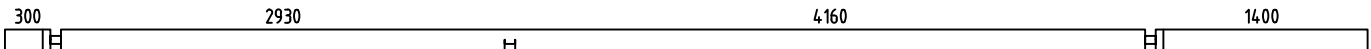

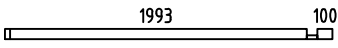

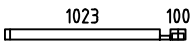

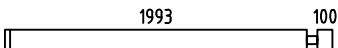
Ganges, Art.No.702041

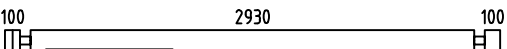
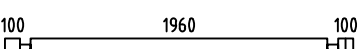
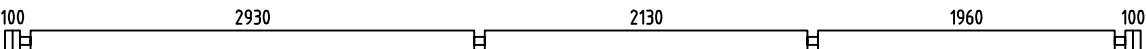
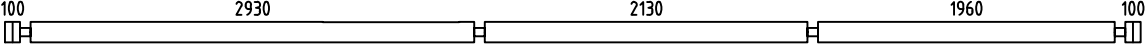
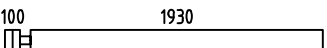
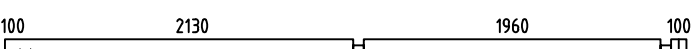
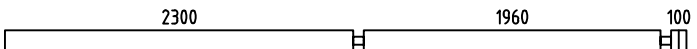
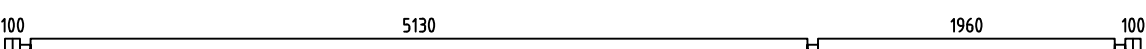



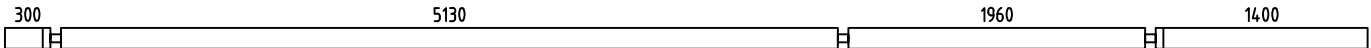
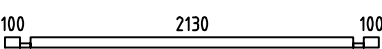
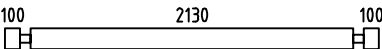
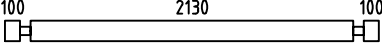
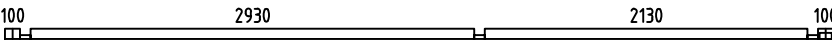
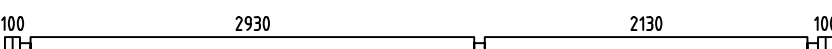

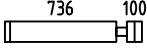
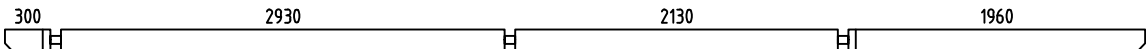
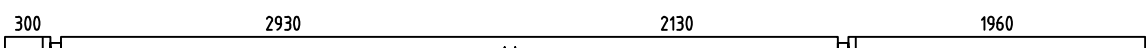
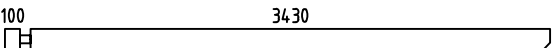
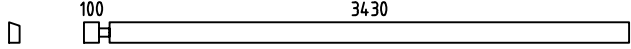
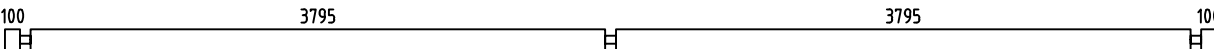
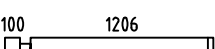
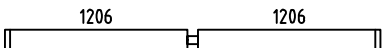
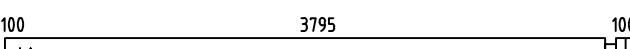
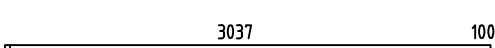
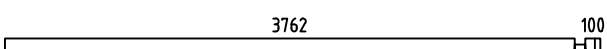
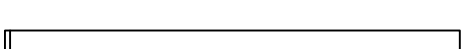
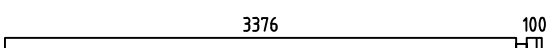
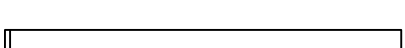
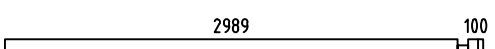
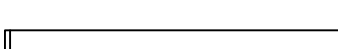
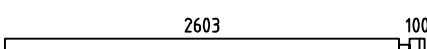



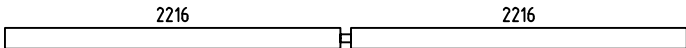
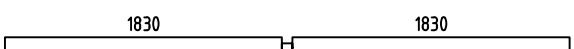
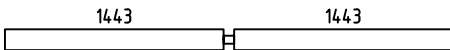
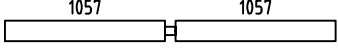
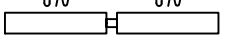
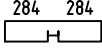

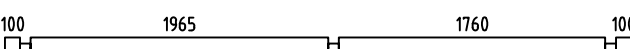

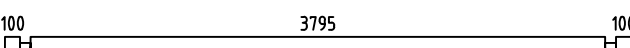
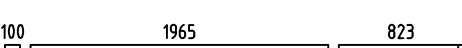
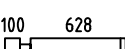
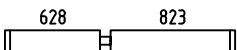
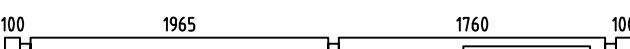
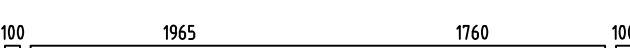
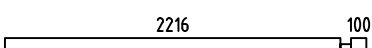

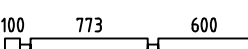
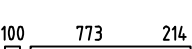
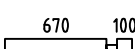

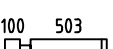

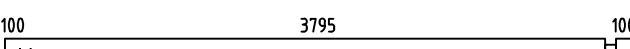
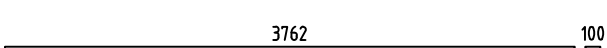

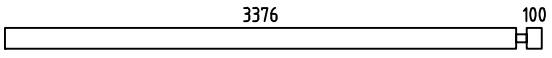
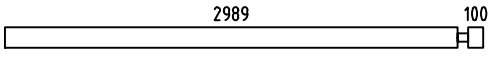
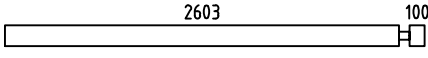
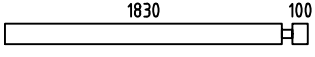
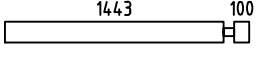
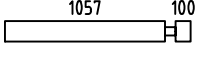

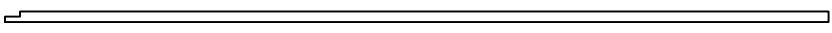
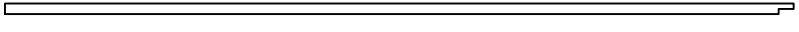
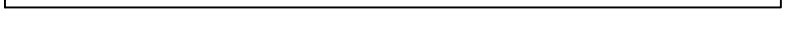



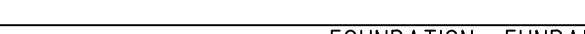
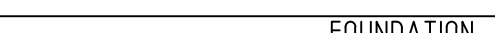
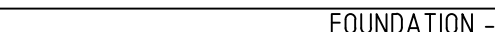
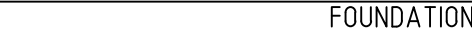

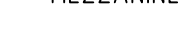

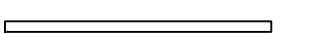
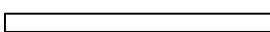
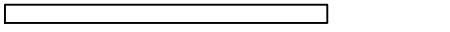



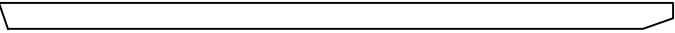
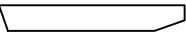
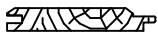

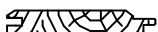
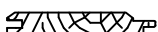
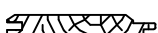

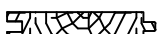
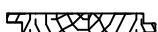
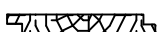



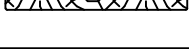
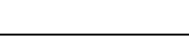

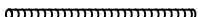

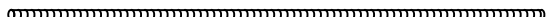







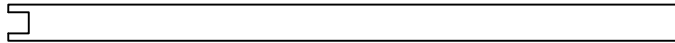
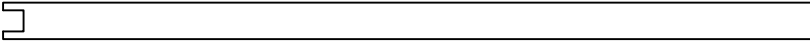
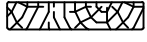
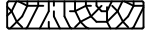
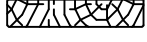





Pos	Ganges, Art.No.702041 Piece list - Stückliste - Liste des pieces	Q.	P (mm)	L (mm)
001		1	70x68	7500
002		1	70x136	7500
003		12	70x136	4193
004		12	70x136	994
005		26	70x136	1193
006		1	70x136	7500
007		2	70x136	7500
008		1	70x136	9000
009		1	70x136	9000
010		1	70x68	270
011		1	70x68	2163
012		1	70x68	270
013		1	70x68	1193
014		14	70x136	270
015		14	70x136	2163
016		33	70x136	270
017		1	70x136	3270
018		1	70x136	2300
019		1	70x136	7500
020		1	70x136	7500
021		7	70x136	2100
022		1	70x136	4500
023		6	70x136	4500
024		1	70x136	7500
025		1	70x136	9000

Pos	Ganges, Art.No.702041 Piece list - Stückliste - Liste des pieces	Q.	P (mm)	L (mm)
026		2	70x136	9000
027		1	70x68	2470
028		15	70x136	2470
029		1	70x136	2470
030		1	70x68	5470
031		11	70x136	5470
032		5	70x136	3906
033		5	70x136	906
034		1	70x136	7530
035		1	70x136	7530
036		1	70x136	3600
037		1	70x136	3600
038		11	70x136	8000
039		14	70x136	1376
040		7	70x136	2481
041		1	70x136	4135
042		2	70x136	3207
043		1	70x136	3932
044		2	70x136	3004
045		1	70x136	3546
046		2	70x136	2618
047		1	70x136	3159
048		2	70x136	2231
049		1	70x136	2773
050		2	70x136	1845



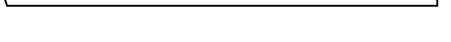

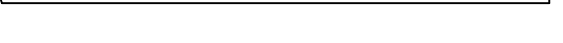
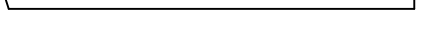
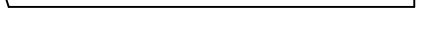



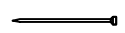

Pos	Ganges, Art.No.702041 Piece list - Stückliste - Liste des pieces	Q.	P (mm)	L (mm)
051		1	70x136	4502
052		1	70x136	3729
053		1	70x136	2956
054		1	70x136	2183
055		1	70x136	1410
056		1	70x136	637
057		17	70x136	270
058		17	70x136	4135
059		1	70x136	8000
060		7	70x136	4135
061		5	70x136	3028
062		9	70x136	798
063		9	70x136	1521
064		1	70x136	4135
065		1	70x136	4135
066		2	70x136	2386
067		1	70x136	2000
068		1	70x136	1613
069		1	70x136	1227
070		2	70x136	840
071		2	70x136	454
072		26	70x136	673
073		13	70x136	573
074		1	70x136	4135
075		1	70x136	3932

Pos	Ganges, Art.No.702041 Piece list - Stückliste - Liste des pieces	Q.	P (mm)	L (mm)
076		1	70x136	3546
077		1	70x136	3159
078		1	70x136	2773
079		1	70x136	2000
080		1	70x136	1613
081		1	70x136	1227
082		3	70x10	837
IAR5	FOUNDATION - FUNDAMENT - FONDATION 	3	70x70	5440
IAR9	FOUNDATION - FUNDAMENT - FONDATION 	4	70x70	5210
IAR6	FOUNDATION - FUNDAMENT - FONDATION 	6	70x70	5125
IAR11	FOUNDATION - FUNDAMENT - FONDATION 	3	70x70	4245
IAR2	FOUNDATION - FUNDAMENT - FONDATION 	2	70x70	3945
IAR1	FOUNDATION - FUNDAMENT - FONDATION 	2	70x70	3945
IAR3	FOUNDATION - FUNDAMENT - FONDATION 	2	70x70	3755
IAR10	FOUNDATION - FUNDAMENT - FONDATION 	1	70x70	3240
IAR7	FOUNDATION - FUNDAMENT - FONDATION 	5	70x70	3155
IAR4	FOUNDATION - FUNDAMENT - FONDATION 	6	70x70	3010
IAR8	FOUNDATION - FUNDAMENT - FONDATION 	1	70x70	2400
IAR13	FOUNDATION - FUNDAMENT - FONDATION 	3	70x70	2045
IAR12	FOUNDATION - FUNDAMENT - FONDATION 	5	70x70	1125
VT1	MEZZANINE FLOOR JOISTS -HALBGESCHOSS BALKEN - SOLIVES DE PLANCHER MEZZANINE 	1	45x70	3795
VT2	MEZZANINE FLOOR JOISTS -HALBGESCHOSS BALKEN - SOLIVES DE PLANCHER MEZZANINE 	3	45x70	1965
VT3	MEZZANINE FLOOR JOISTS -HALBGESCHOSS BALKEN - SOLIVES DE PLANCHER MEZZANINE 	3	45x70	1760
VT4	MEZZANINE FLOOR JOISTS -HALBGESCHOSS BALKEN - SOLIVES DE PLANCHER MEZZANINE 	8	44x120	2930
VT5	MEZZANINE FLOOR JOISTS -HALBGESCHOSS BALKEN - SOLIVES DE PLANCHER MEZZANINE 	7	44x120	2130

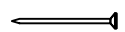
Pos	Ganges, Art.No.702041 Piece list - Stückliste - Liste des pieces	Q.	P (mm)	L (mm)
SR1	RAFTER - DACHSPARREN - CHEVRON 	33	70x170	4453
SR2	RAFTER - DACHSPARREN - CHEVRON 	3	70x170	1227
STP	CEILING BOARDS - DECKENBRETTER - VOLIGES SOUS PLAFOND 	37	111x15	1931
STP	CEILING BOARDS - DECKENBRETTER - VOLIGES SOUS PLAFOND 	55	111x15	3196
STP	CEILING BOARDS - DECKENBRETTER - VOLIGES SOUS PLAFOND 	18	111x15	3960
STP	CEILING BOARDS - DECKENBRETTER - VOLIGES SOUS PLAFOND 	19	111x15	3828
STP	CEILING BOARDS - DECKENBRETTER - VOLIGES SOUS PLAFOND 	19	111x15	3328
PTL	FLOOR BOARDS - FUSSBODENBRETTER - LAME DE PLANCHER 		137x28	540.19 m
RB3	ROOF BOARDS - DACHBRETTER - VOLIGES 	100	90x18	5605
RB2	ROOF BOARDS - DACHBRETTER - VOLIGES 	64	90x18	3395
RB1	ROOF BOARDS - DACHBRETTER - VOLIGES 	36	90x18	1925
SV2	TERRACE BOARDS - TERRASSENBRETTER - PLANCHER DE TERRASSE 	5	120x28	5192
SV2	TERRACE BOARDS - TERRASSENBRETTER - PLANCHER DE TERRASSE 	5	120x28	4631
SV2	TERRACE BOARDS - TERRASSENBRETTER - PLANCHER DE TERRASSE 	15	120x28	3865
SV2	TERRACE BOARDS - TERRASSENBRETTER - PLANCHER DE TERRASSE 	5	120x28	3169
SV2	TERRACE BOARDS - TERRASSENBRETTER - PLANCHER DE TERRASSE 	5	120x28	2608
LL	CEILING FILLET - DECKELEISTE - PROFIL DE FINITION POUR SOUS PLAFOND 		15x40	56 m
	FLOOR FILLET-FUSSBODENLEISTE - CORNIERE DE FINITION DU PLANCHER 		15x40	65 m
M1	TREADED ROD M12 - GEWINDESTANGE M12 - TIGE FILETÉE M12 	2		506
M2	TREADED ROD M12 - GEWINDESTANGE M12 - TIGE FILETÉE M12 	2		545
M3	TREADED ROD M12 - GEWINDESTANGE M12 - TIGE FILETÉE M12 	1		1866
M4	TREADED ROD M12 - GEWINDESTANGE M12 - TIGE FILETÉE M12 	1		1910
M5	TREADED ROD M12 - GEWINDESTANGE M12 - TIGE FILETÉE M12 	6		2000
DPL1	ROOFING FELT FILLET - DACHPAPPENLEISTE - BAGUETTE DE FIXATION DU FEUTRE BITUMEUX 	4	18x58	4519
DPL2	ROOFING FELT FILLET - DACHPAPPENLEISTE - BAGUETTE DE FIXATION DU FEUTRE BITUMEUX 	4	18x58	4519

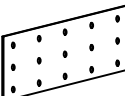
Pos	Ganges, Art.No.702041 Piece list - Stückliste - Liste des pieces	Q.	P (mm)	L (mm)
LPL	FIXING FILLET - FIXIRUNGSLEISTE - PROFIL DE FIXATION 	1	18x70	791
LPL	FIXING FILLET - FIXIRUNGSLEISTE - PROFIL DE FIXATION 	2	18x70	1933
P1	POST - PFOSTEN - POTEAU 	2	120x120	2135
P2	POST - PFOSTEN - POTEAU 	1	120x120	3222
TB1	EAVES BOARD - TRAUFBRETT - BANDEAU DE TOIT 	12	18x120	560
TB2	EAVES BOARD - TRAUFBRETT - BANDEAU DE TOIT 	32	18x120	562
TB3	EAVES BOARD - TRAUFBRETT - BANDEAU DE TOIT 	1	18x120	1434
TB4	EAVES BOARD - TRAUFBRETT - BANDEAU DE TOIT 	1	18x120	1925
TB5	EAVES BOARD - TRAUFBRETT - BANDEAU DE TOIT 	1	18x120	3395
TB6	EAVES BOARD - TRAUFBRETT - BANDEAU DE TOIT 	2	18x120	5605
TBE6	FIXING FILLET FOR WINDOW - FIXIRUNGSLEISTE FÜR FENSTER - PROFIL DE FIXATION DES FENETRES 	4	28x34	616
TBE6	FIXING FILLET FOR WINDOW - FIXIRUNGSLEISTE FÜR FENSTER - PROFIL DE FIXATION DES FENETRES 	6	28x34	650
TBE6	FIXING FILLET FOR WINDOW - FIXIRUNGSLEISTE FÜR FENSTER - PROFIL DE FIXATION DES FENETRES 	2	28x34	1190
TBE6	FIXING FILLET FOR WINDOW - FIXIRUNGSLEISTE FÜR FENSTER - PROFIL DE FIXATION DES FENETRES 	4	28x34	1564
TBE6	FIXING FILLET FOR WINDOW - FIXIRUNGSLEISTE FÜR FENSTER - PROFIL DE FIXATION DES FENETRES 	4	28x34	1729
TBE6	FIXING FILLET FOR DOOR - FIXIRUNGSLEISTE FÜR TÜR - PROFIL DE FIXATION DES PORTES 	2	28x34	1826
TBE6	FIXING FILLET FOR DOOR - FIXIRUNGSLEISTE FÜR TÜR - PROFIL DE FIXATION DES PORTES 	4	28x34	1920
TG1	GUARD-RAIL FOR TERRACE - TERRASSEN GELÄNDER - MAIN COURANTE DE TERRASSE 	1	18x90	1600
GL1	GABLE MOULDING - GIEBELLEISTE - PLANCHE DE RIVE 	1	18x90	1293
GL2	GABLE MOULDING - GIEBELLEISTE - PLANCHE DE RIVE 	1	18x90	3589
GL3	GABLE MOULDING - GIEBELLEISTE - PLANCHE DE RIVE 	3	18x90	4519
GL4	GABLE MOULDING - GIEBELLEISTE - PLANCHE DE RIVE 	1	18x120	1261
GL5	GABLE MOULDING - GIEBELLEISTE - PLANCHE DE RIVE 	1	18x120	1293
GL6	GABLE MOULDING - GIEBELLEISTE - PLANCHE DE RIVE 	1	18x120	3557
GL7	GABLE MOULDING - GIEBELLEISTE - PLANCHE DE RIVE 	1	18x120	3589

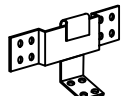
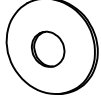
Pos	Ganges, Art.No.702041 Piece list - Stückliste - Liste des pieces	Q.	P (mm)	L (mm)
GL8	GABLE MOULDING - GIEBELLEISTE - PLANCHE DE RIVE 	3	18x120	4488
GL9	GABLE MOULDING - GIEBELLEISTE - PLANCHE DE RIVE 	3	18x120	4519
SP1	HIDDEN FIXING - HOLZDÜBEL - TOURILLON BOIS 	6	18x18	260
KL4	LENGTHENING BOLT FOR TREADED ROD - VERLÄNGERUNGSMUTTER FÜR GEWINDESTANGE - MANCHON DE RACCORDEMENT DE TIGE FILETÉE 	6		
KL1	DRIVE NUT TREADED ROD - EINSHLAGMUTTER FÜR GEWINDESTANGE - ÉCROU A FRAPPER POUR TIGE FILITÉE 	6		
KL2	NUT FOR TREADED ROD - MUTTER FÜR GEWINDESTANGE - ÉCROU POUR TIGE FILETÉE 	6		
KL3	PLAIN WASHER TREADED ROD - UNTERLEGSCHIEBE FÜR GEWINDESTANGE - RONDELLE PLATE POUR TIGE FILETÉE 	6		
HS12	SCREW FOR GABLE SEGMENT - SCHRAUBEN FÜR DECKBLATT - VIS POUR FIXATION LOSANGE DE FINITION 	4	3.5x50	
HS83	SCREW FOR FIXING FILLET - SCHRAUBEN FÜR FIXIRUNGSLEISTE - VIS POUR PROFIL DE FIXATION 	13	3.5x50	
HS32	SCREW FOR EAVES BOARDS - SCHRAUBEN FÜR TRAUFBRETTER - VIS DE FIXATION POUR BANDEAU DE TOIT 	66	3.5x50	
HS84	SCREW FOR FIXING FILLET - SCHRAUBEN FÜR FIXIRUNGSLEISTE - VIS POUR PROFIL DE FIXATION 	112	3.5x50	
HS16	SCREW FOR GABLE MOULDING - SCHRAUBEN FÜR GIEBELLEISTE - VIS DE FIXATION POUR PLANCHE DE RIVE 	126	3.5x50	
NFD	SCREW FOR ROOFING FELT FILLET - SCHRAUBEN FÜR DACHPAPPENLEISTE - VIS POUR BAGUETTE FIXATION FEUTRE BITUMEUX 	44	4x40	
HS73	SCREW FOR CONNECTING PLATE - SCHRAUBE FÜR ANSCHLUSSPLATTE - VIS DE FIXATION DES PLAQUES DE CONNEXION 	144	4x40	
HS32	SCREW FOR EAVES BOARDS - SCHRAUBEN FÜR TRAUFBRETTER - VIS DE FIXATION POUR BANDEAU DE TOIT 	132	4x40	
HS86	SCREW FOR RAFTER SLIDER - SCHRAUBEN FÜR DACHSPARREN SCHIEBEREGLER - VIS DE FIXATION CURSEUR POUR CHEVRON 	288	4x40	
HS30	SCREW FOR TERRACE REAR BOARDS - SCHRAUBEN FÜR TERRASSENRAND - VIS DE FIXATION POUR MAIN COURANTE DE TERRASSE 	4	4x40	
HS34	SCREW FOR POST - SCHRAUBEN FÜR PFOSTEN - VIS DE FIXATION DES POTEAUX 	6	4x60	
HS30	SCREW FOR TERRACE RAILING - SCHRAUBEN FÜR TERRASSENRAND VIS DE GARDE-CORPS DE TERRASSE 	4	4x60	
HS36	SCREW FOR STEPLADDER - SCHRAUBE FÜR LEITER - VIS D'ASSEMBLAGE DES MARCHES DE L'ECHELLE 	36	4x60	
HS86	SCREW FOR MEZZANINE FLOOR JOISTS - SCHRAUBEN FÜR HALBGESCHOSS BALKEN - VIS DE FIXATION SOLIVES DE PLANCHER MEZZANINE 	68	5x100	
HS40	SCREW FOR 1. WALL BEAM - SCHRAUBE FÜR 1. BOHLENREIHE - VIS DE FIXATION DES FONDATIONS 	19	5x120	
HS39	SCREW FOR FUNDAMENT - SCHRAUBEN ZUR BEFESTIGUNG FUNDAMENT - VIS POUR FONDATION 	100	5x120	
HS49	SCREW FOR POST HEIGHT ADJUSTMENT - SCHRAUBEN FÜR REGULIERUNGSSCHRAUBE FÜR PFOSTEN - VIS DE FIXATION DE SUPPORT RÉGLABLE DE POTEAU 	24	6x50	
HS15	SCREW FOR RAFTER - SCHRAUBEN ZUR BEFESTIGUNG DACHSPARREN VIS POUR CHEVRON 	36	8x220	

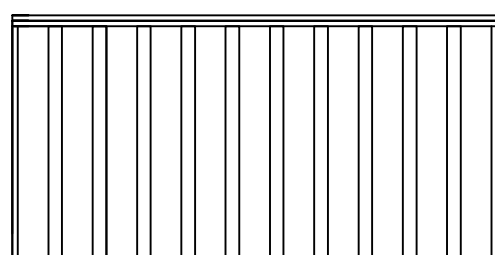
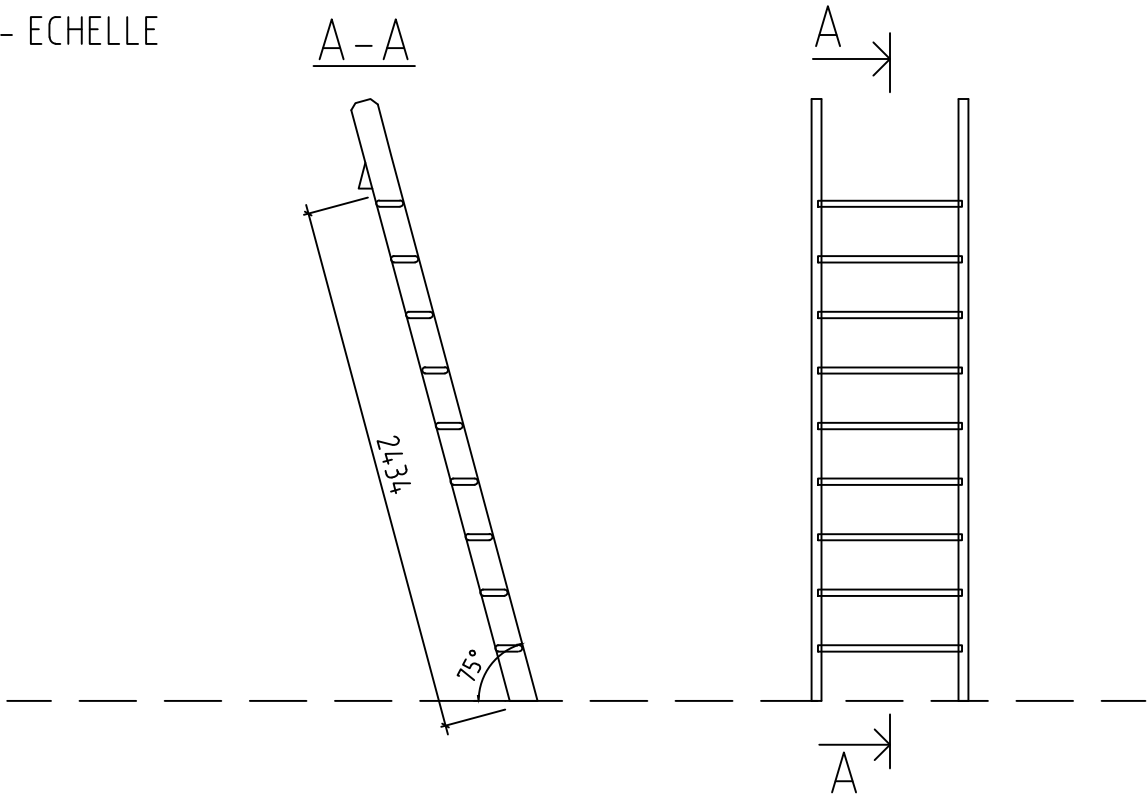
Pos	Ganges, Art.No.702041 Piece list - Stückliste - Liste des pieces		Q.	P (mm)	L (mm)
MS	SCREW FOR DOORSTEP - SCHRAUBEN FÜR TÜRSCHWELLE - VIS DE FIXATION DU SEUIL DE PORTE		6	4.5x65	
SH70	HAMMER BLOCK - SCHLAGHOLZ - CALLE DE FRAPPE		2		
NF3	SCREW FOR TERRACE - SCHRAUBEN FÜR TERRASSENBRETTTER - VIS POUR PLANCHER DE TERRASSE		510	4.2x55	
NFF	ZN NAIL FOR FILLETS - ZN NÄGEL FÜR LEISTEN - POINTE POUR CORNIERE		251	1.4x40	
NF2	ZN NAIL FOR ROOF - ZN NÄGEL FÜR DACHBRETTTER - POINTE POUR TOIT		1835	2x50	
NF2	ZN NAIL FOR CEILING BOARDS - ZN NÄGEL FÜR DECKENBRETTTER - CLOUS POUR VOLIGES SOUS PLAFONDS		1094	2x50	
HS25	SCREW FOR FLOOR - SCHRAUBEN FÜR FUSSBODENBRETTTER - VIS POUR PLANCHER		1050	3.5x50	
KR	CONNECTING PLATE - ANSCHLUSSPLATTE - PLAQUE MÉTALLIQUE DE CONNEXION		18		
ORZ	MONTAGE SET FOR DOORS AND WINDOWS - MONTAGE-SET FÜR TÜREN UND FENSTER - JEU DE MONTAGE PORTES ET FENETRES		1		
PP	BOLT M8 - BOLZEN M8 - BOULON M8		1	18x120	
GS	GABLE SEGMENT-DECKBLATT - LOSANGE DE FINITION		2		
RLGR	SLIDER FOR RAFTER - SCHIEBEREGLER FÜR DACHSPARREN - SABOT MÉTALLIQUE POUR FIXATION CHEVRON		36		
KL5	PLAIN WASHER - UNTERLEGSCHIEBE - RONDELLE		1		
RFP	POST HEIGHT ADJUSTMENT - REGULIERUNGSSCHRAUBE FÜR PFOSTEN - SUPPORT RÉGLABLE DE POTEAU		3		
TRR1	TERRACE RAILING - TERRASSE - GARDE-CORPS DE TERRASSE		1		1600
LR	LADDER - LEITER - ECHELLE		1		

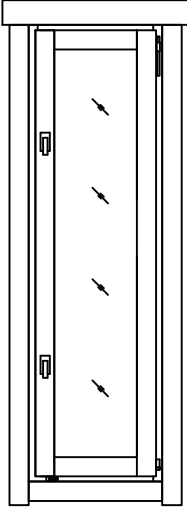
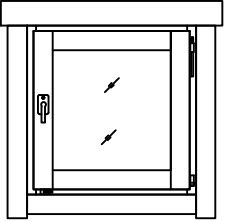
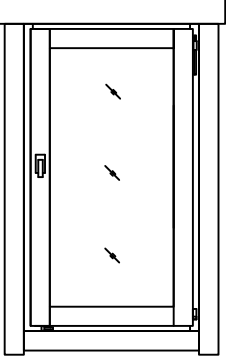
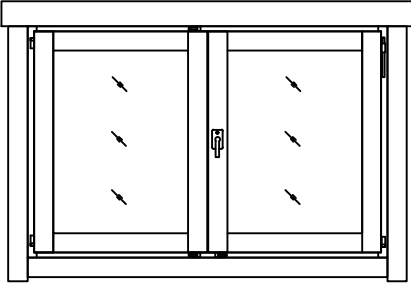
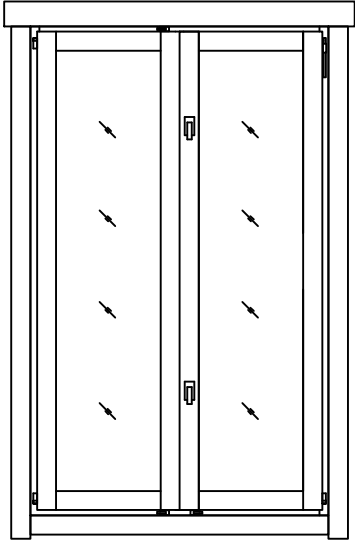
Pos	Ganges, Art.No.702041 Piece list - Stückliste - Liste des pieces	Q.	P (mm)	L (mm)
2+ A.0P.b	WINDOW-FENSTER-FENETRE 552x1729 	2		
2+ A.0P.c	WINDOW-FENSTER-FENETRE 650x650 	3		
2+ A.0P.d	WINDOW-FENSTER-FENETRE 702x1190 	1		
2+ TA.0P	WINDOW-FENSTER-FENETRE 1374x916 	2		
2+ TA.0P.b	WINDOW-FENSTER-FENETRE 1100x1729 	1		

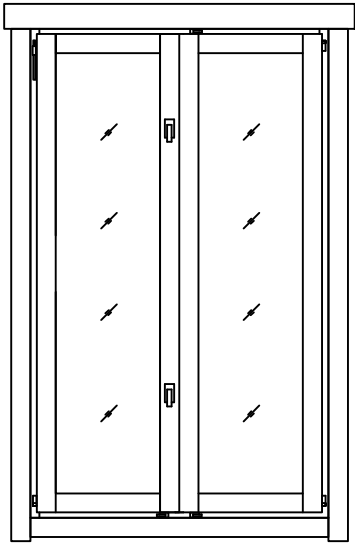
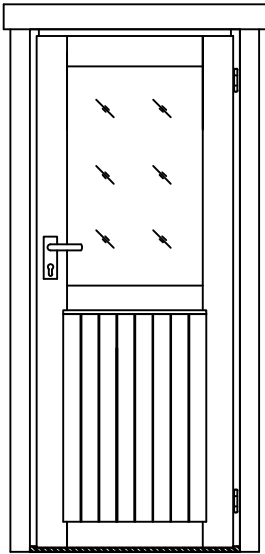
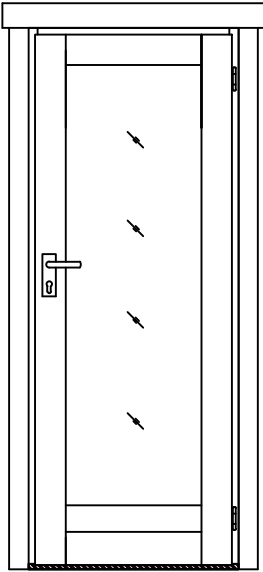
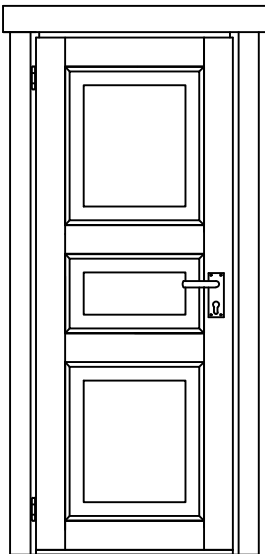
Pos	Ganges, Art.No.702041 Piece list - Stückliste - Liste des pieces	Q.	P (mm)	L (mm)
2+ TA .0V.b	WINDOW-FENSTER-FENETRE 1100x1729 	1		
2+ U.20P	DOOR-TÜR-PORTE 827x1933 	1		
2+ U.10P	DOOR-TÜR-PORTE 827x1933 	1		
U.3TV	DOOR-TÜR-PORTE 827x1933 +LPL 	1		

NB!
LPL: Only for inside doors - Nur für die Innentüren

OP1 Only double door
 Doppeltür
 Seulement double porte

