

CEYLON
Art.No. 706142

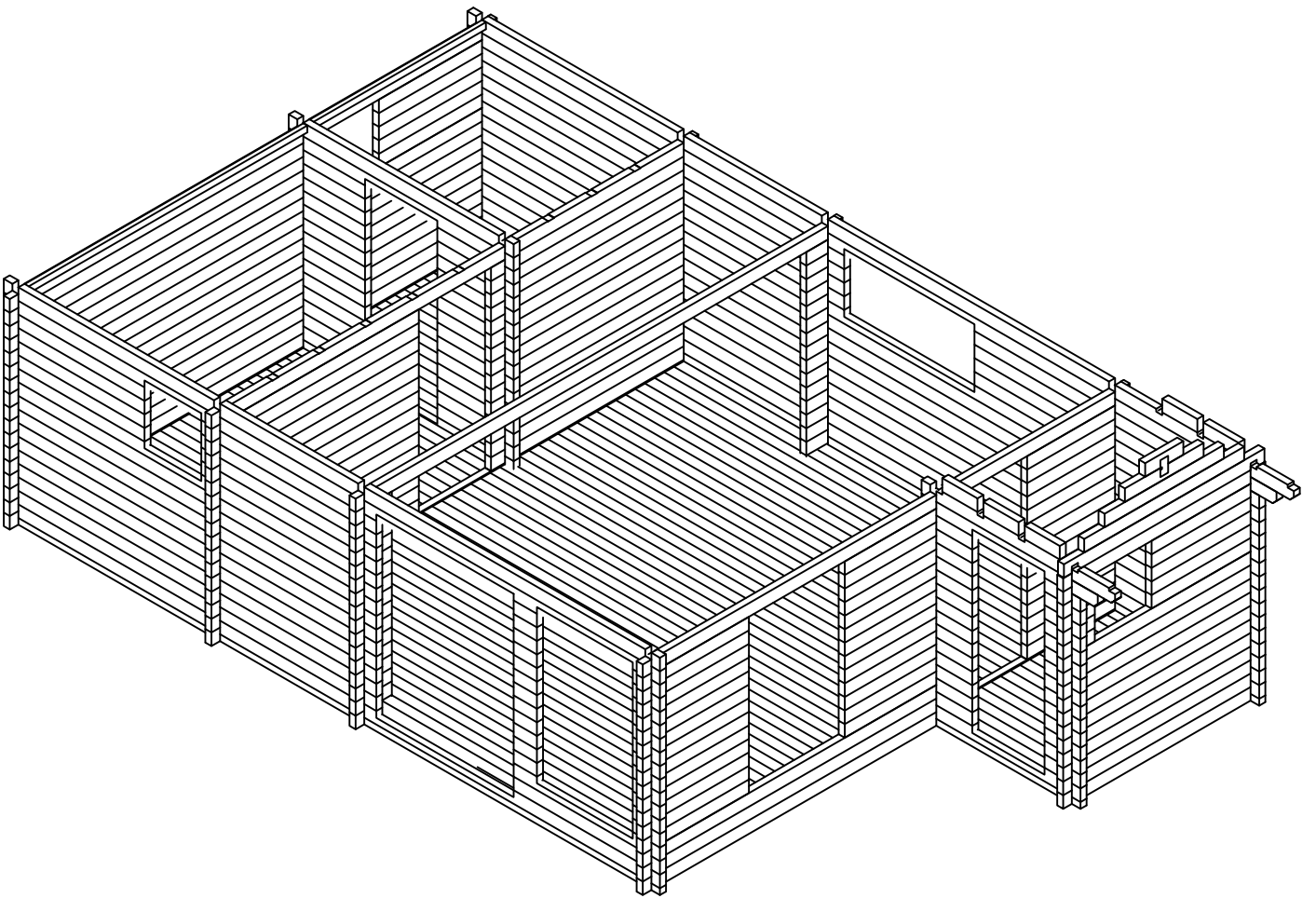

CEYLON
Art.No. 706142

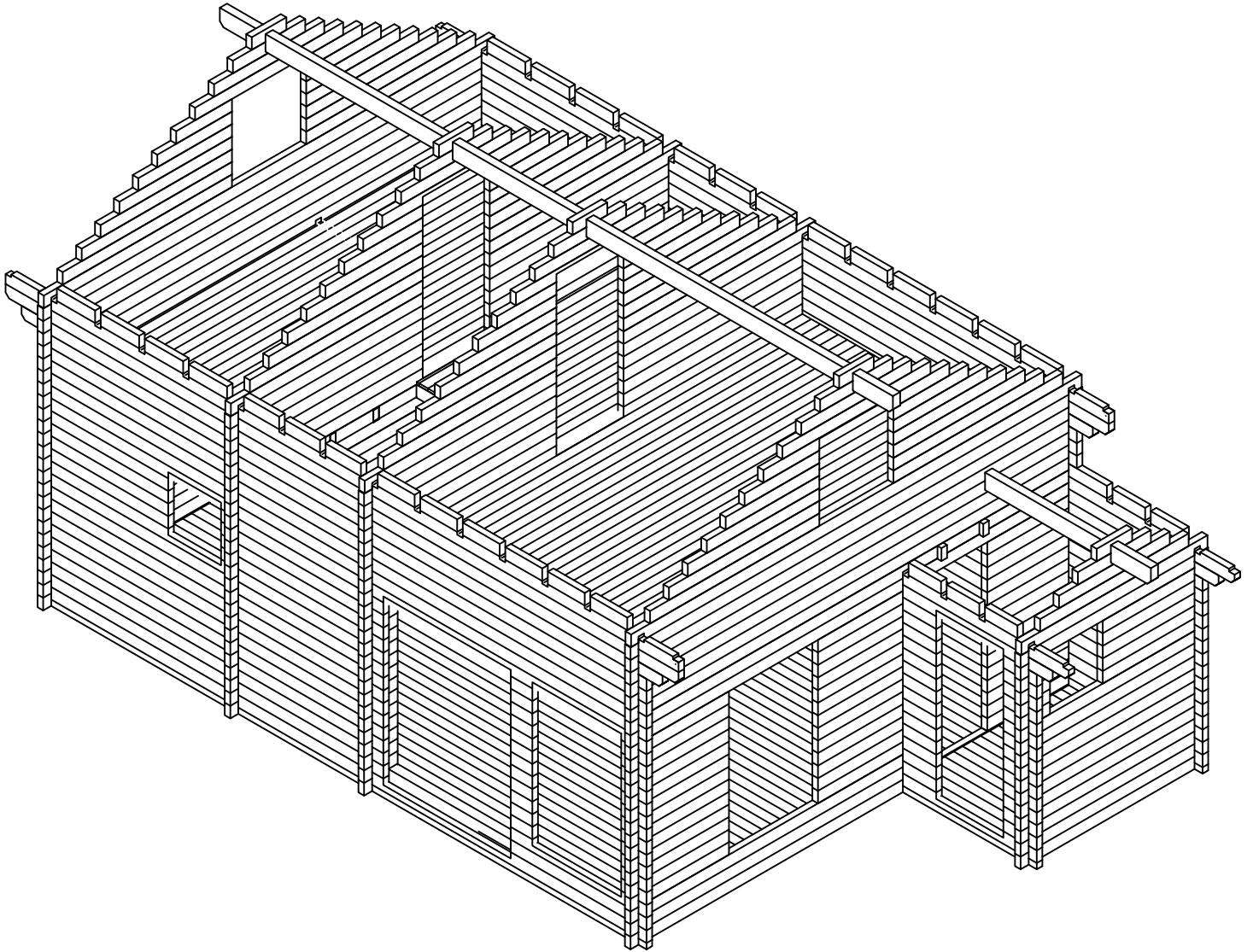

CEYLON, Art.No.706142
 Groundplan - Grundplan - Plan de masse - Planimetria - Plattegrond - Põhiplan

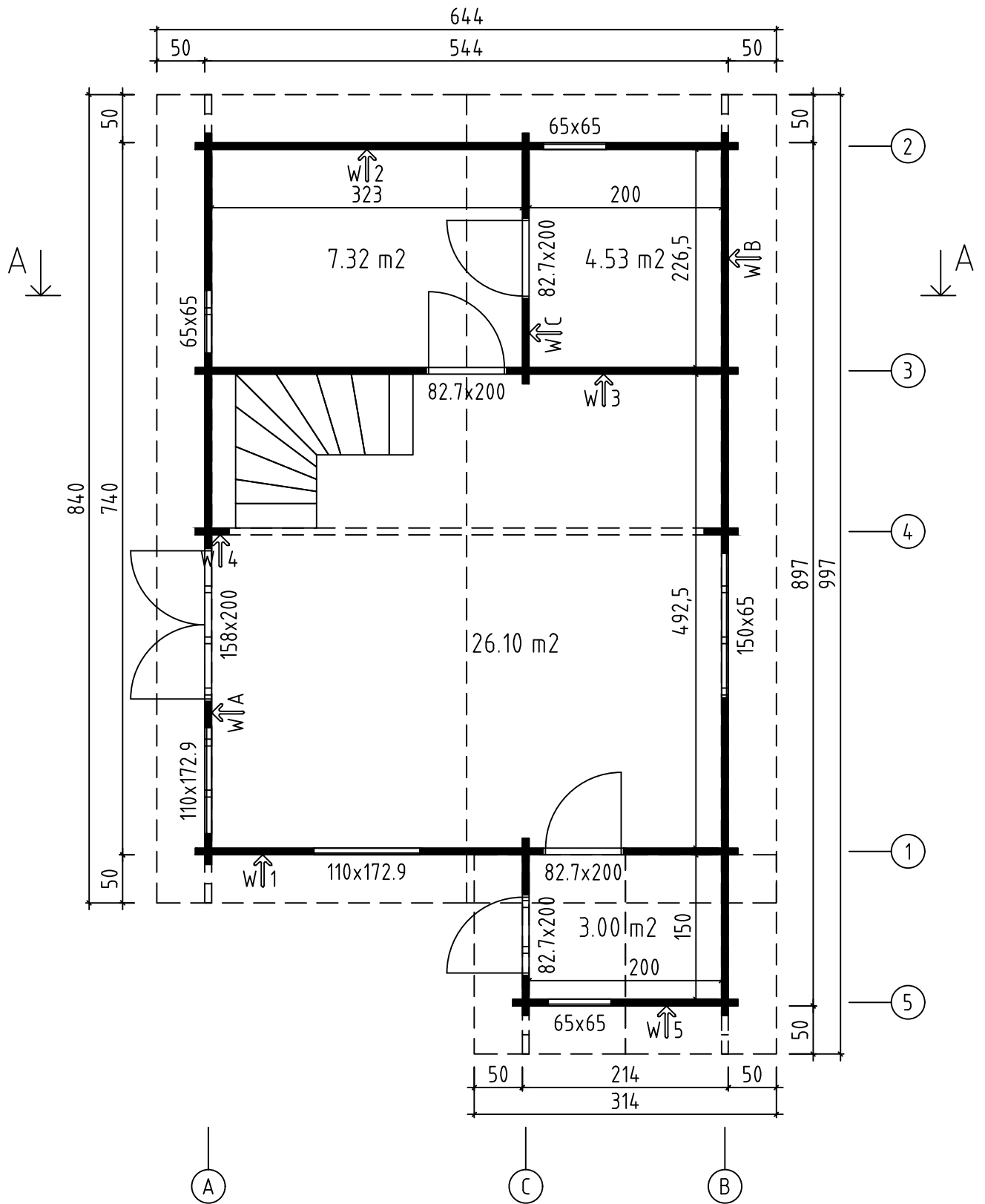

CEYLON, Art.No.706142
Groundplan - Grundplan - Plan de masse - Planimetria - Plattegrond - Põhiplan

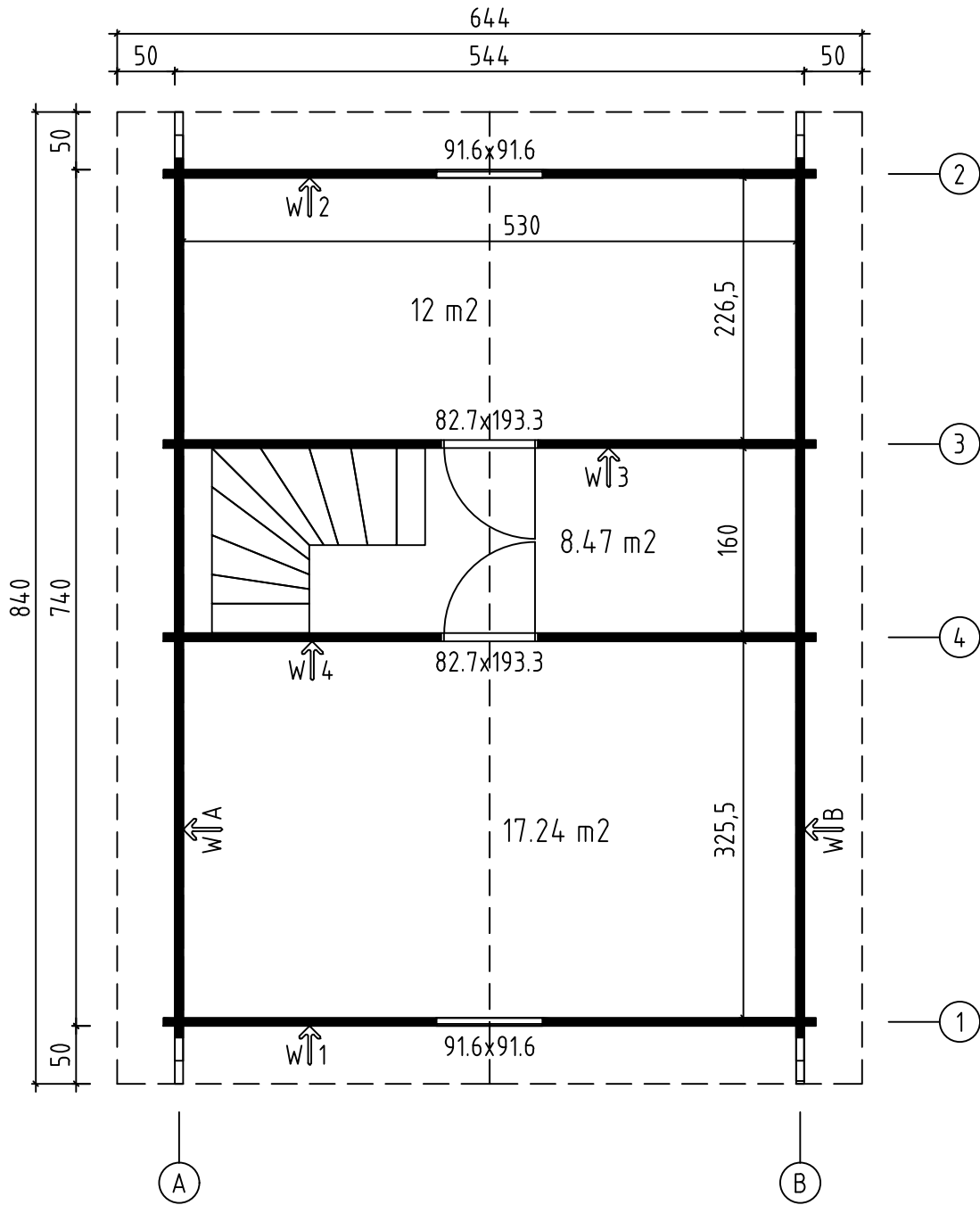

CEYLON, Art.No.706142
 Foundation - Fundament - Fondation - Fondamenta - Fundering - Immutatud alusraam

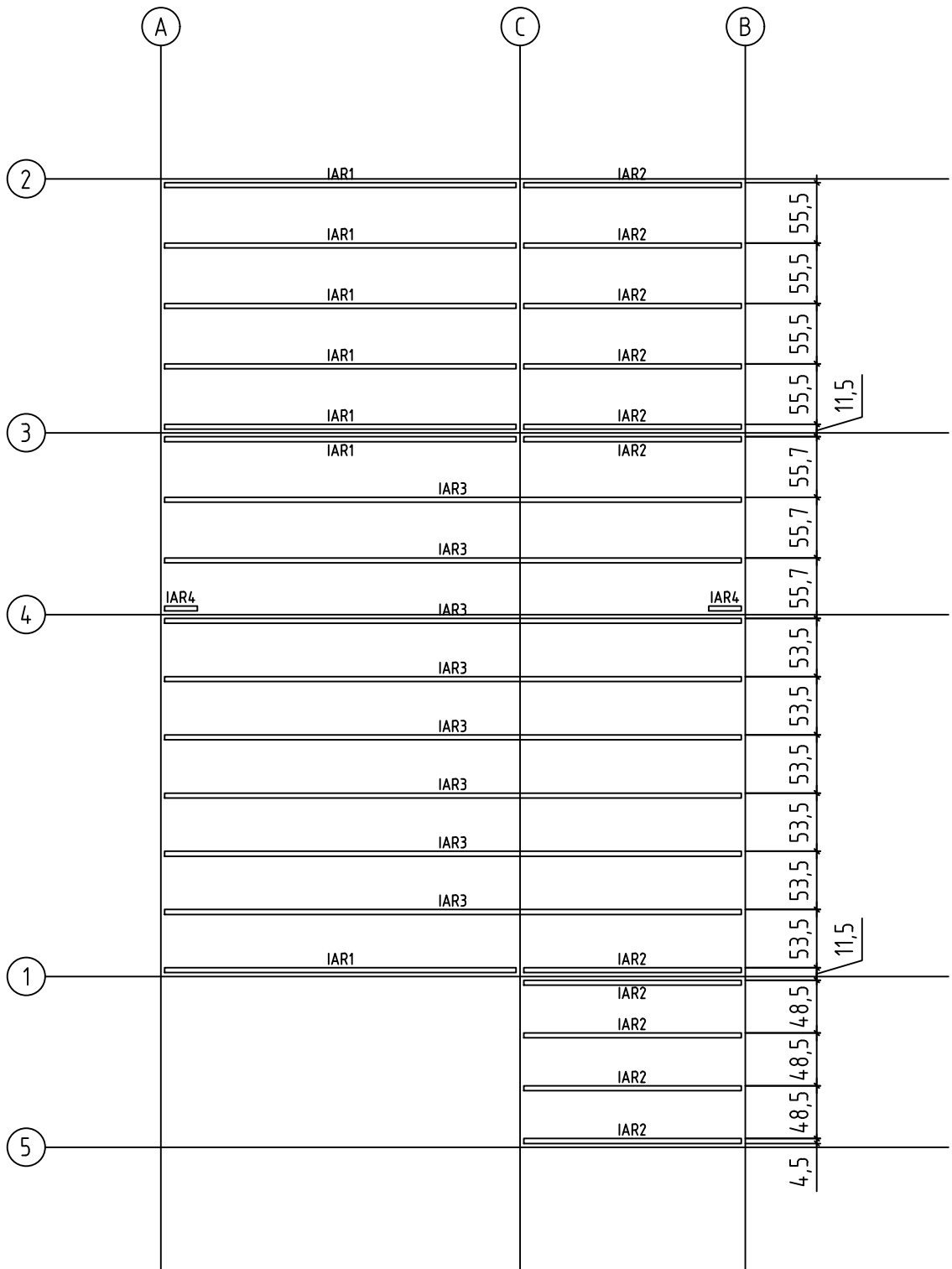

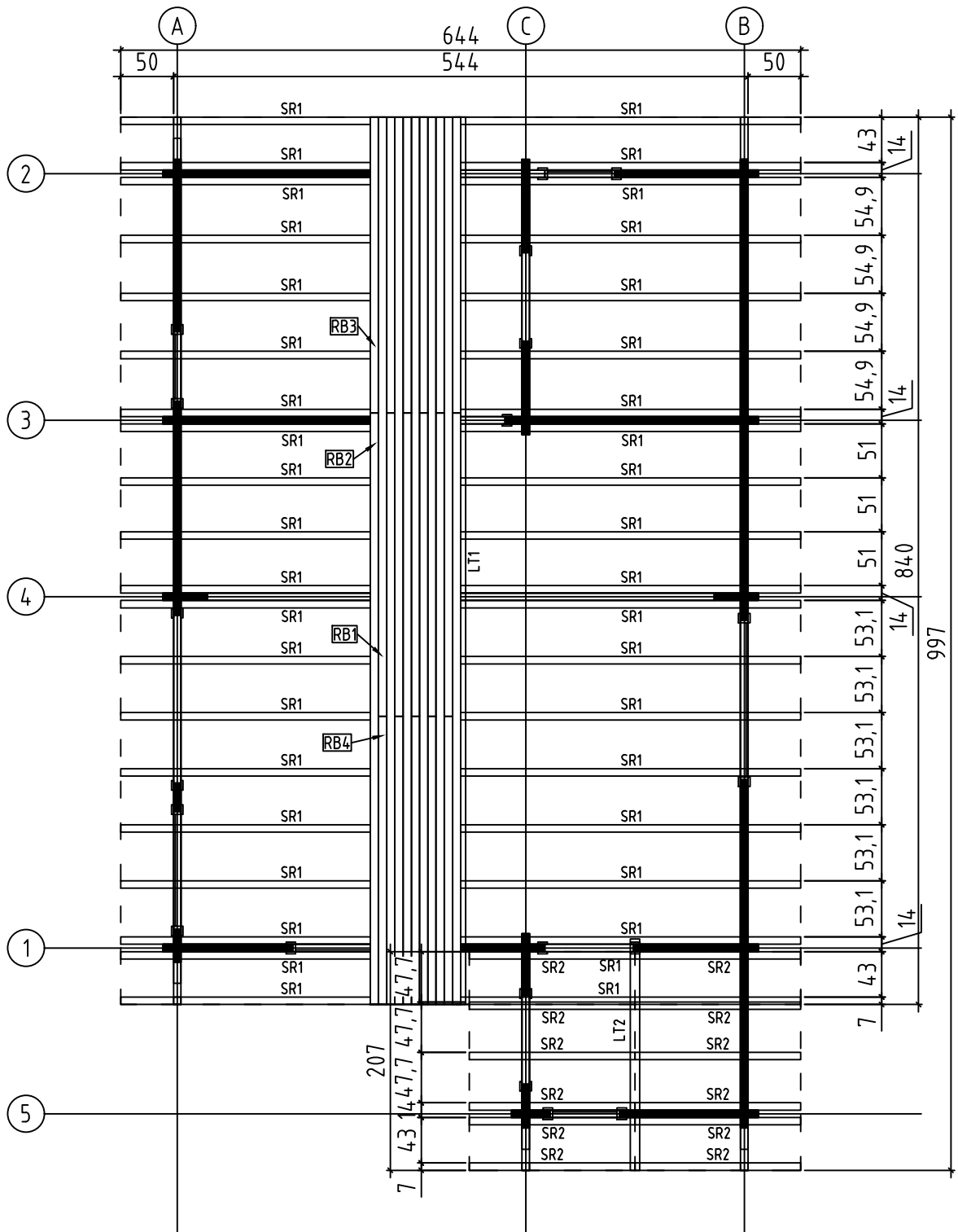

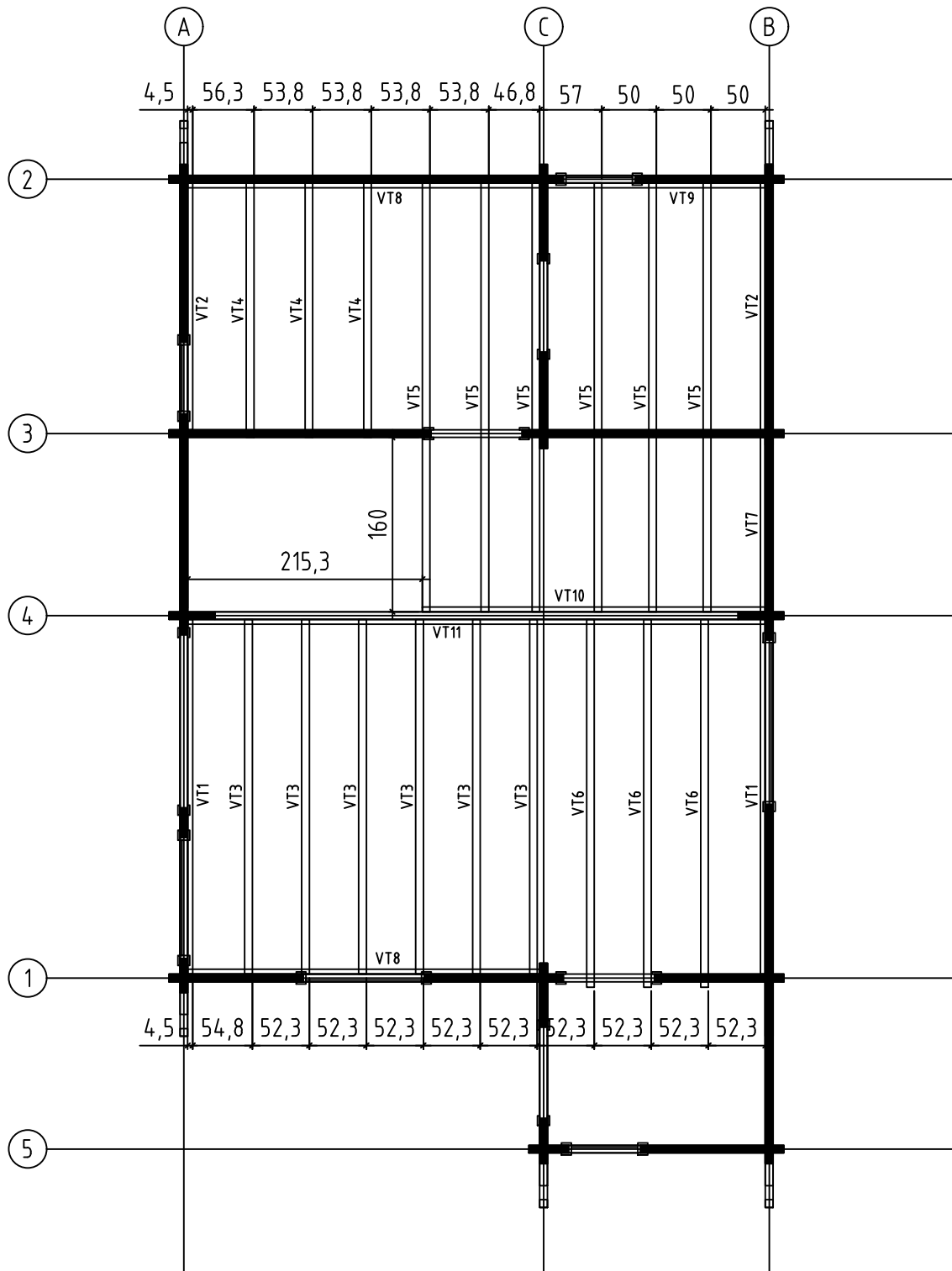

CEYLON, Art.No.706142
Floor boards - Fussbodenbretter - Plan pose plancher - Pavimento - Vloerhout -
Põrandalaudis

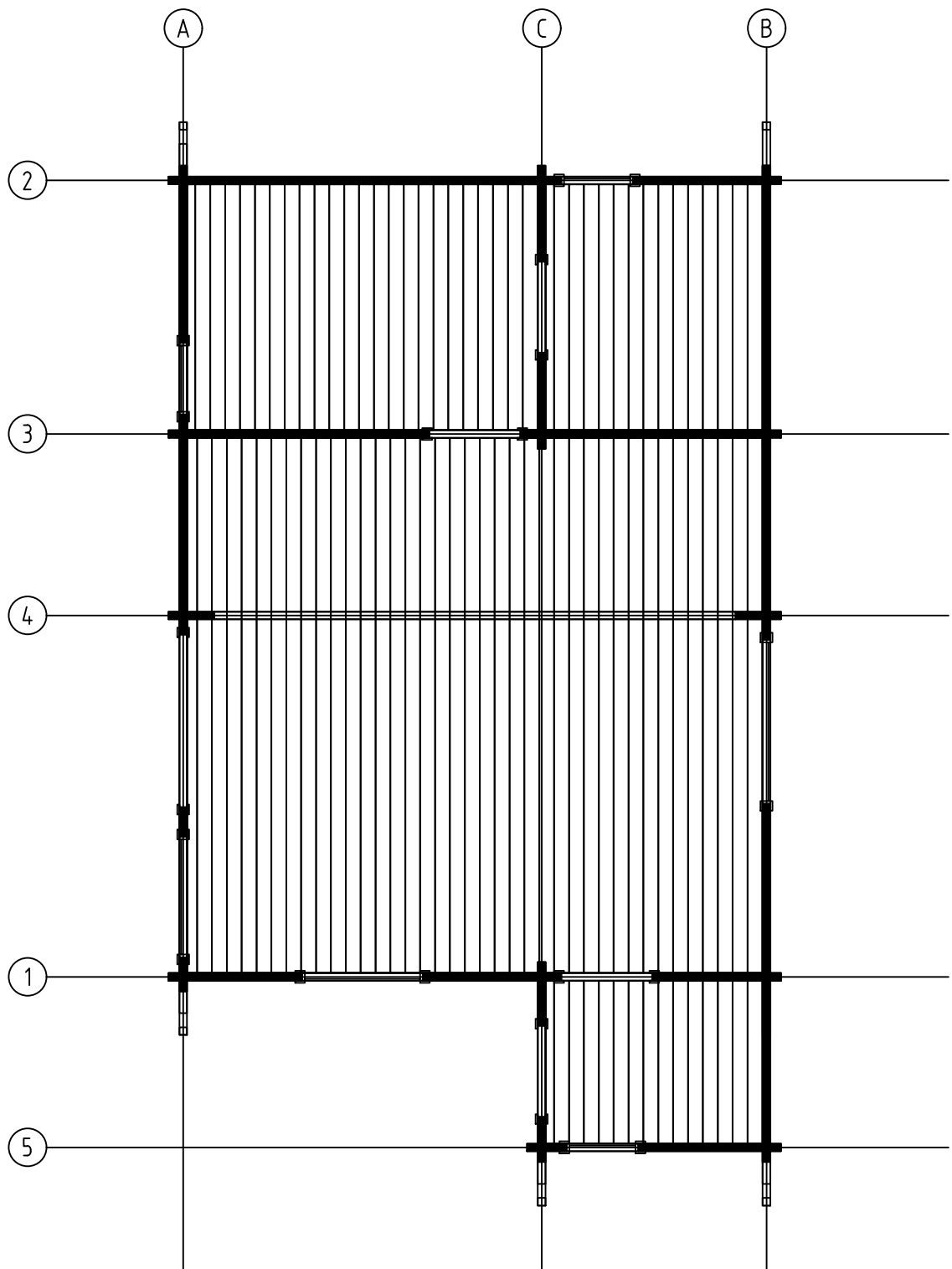

CEYLON, Art.No.706142
Floor boards - Fussbodenbretter - Plan pose plancher - Pavimento - Vloerhout -
Põrandalaudis

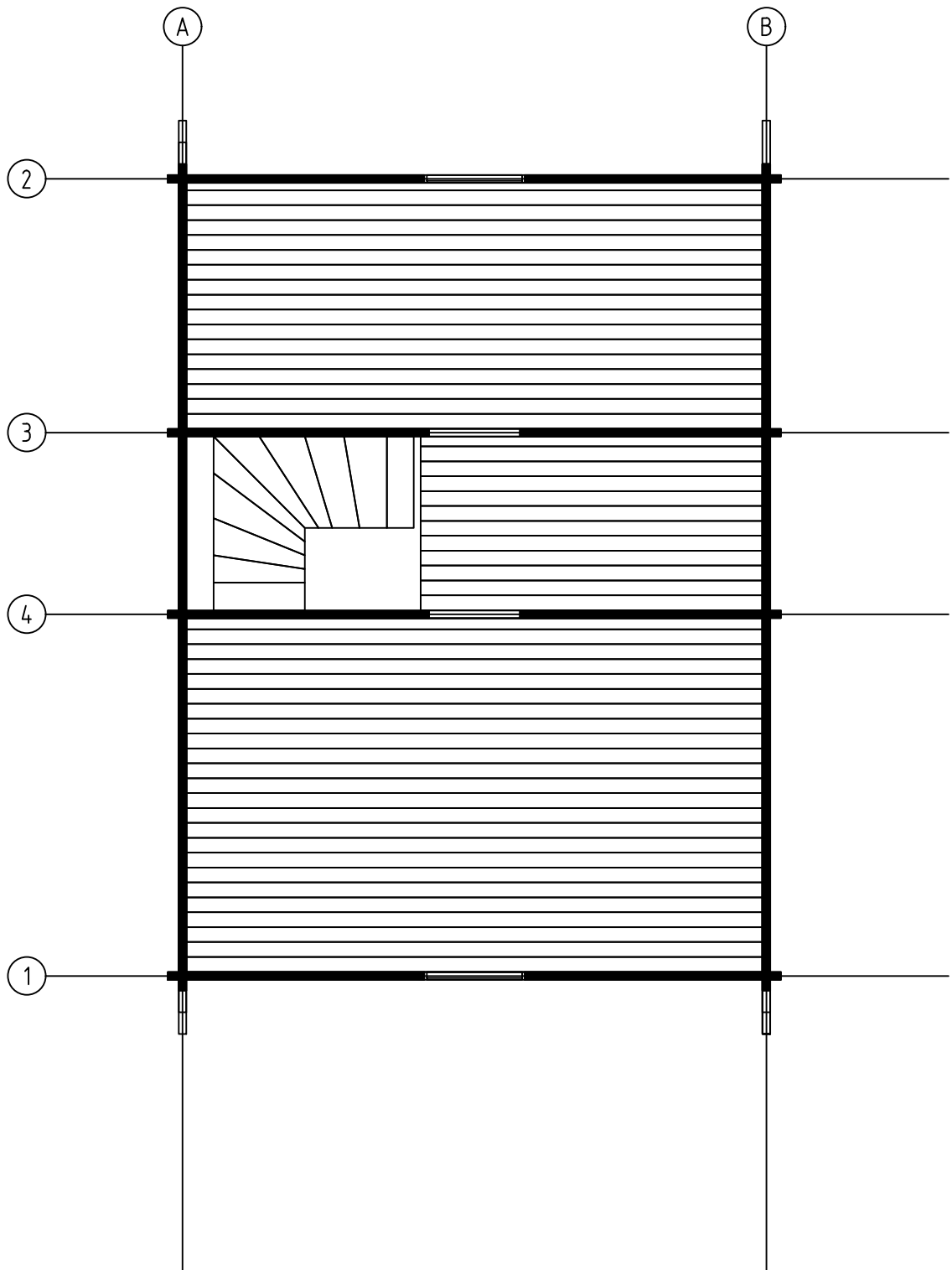

CEYLON, Art.No.706142
Ceiling boards - Deckenbrett - Voliges sous plafond - Tavole per piano soffitto - Dakhout
- Laelaud

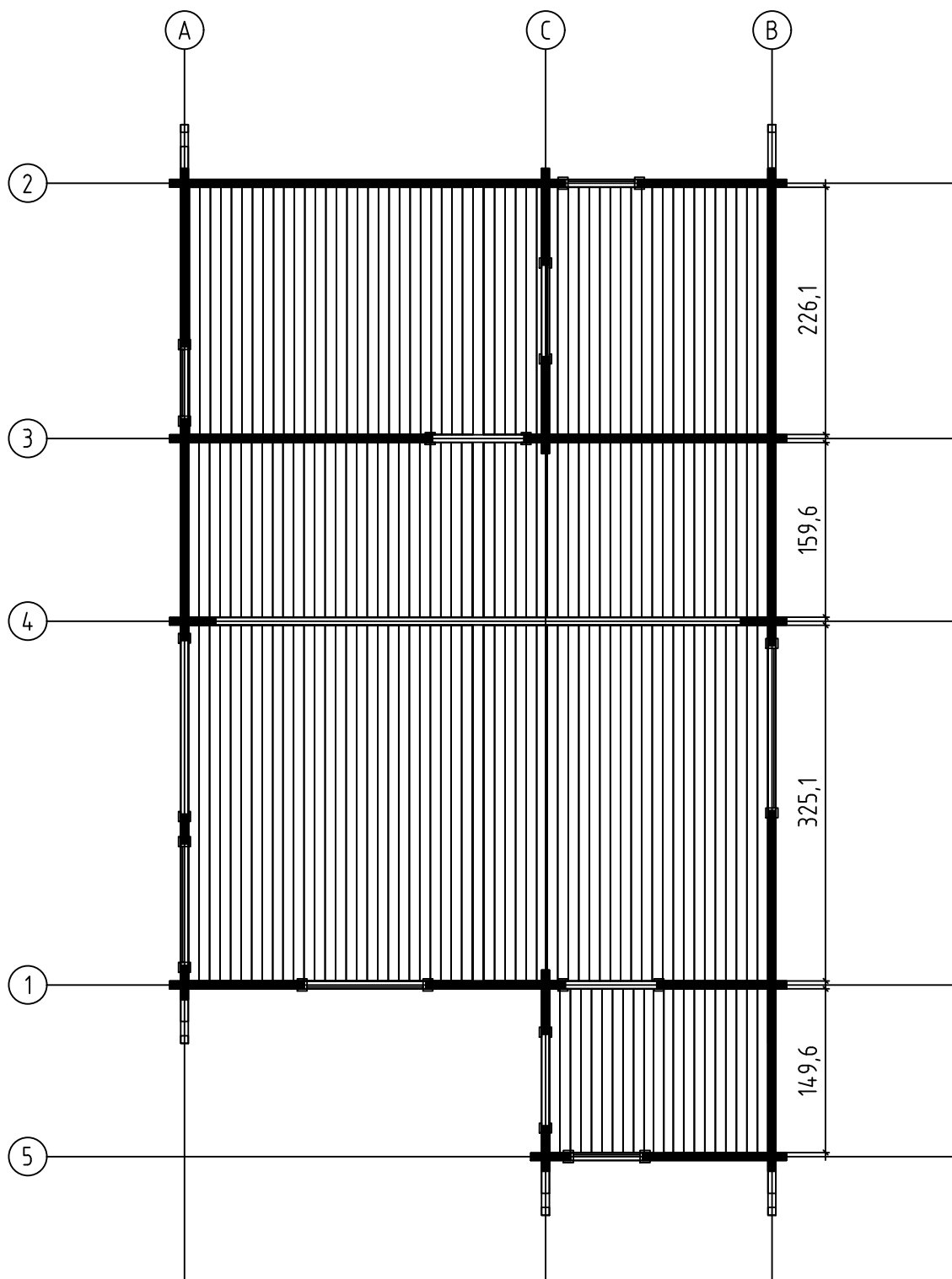

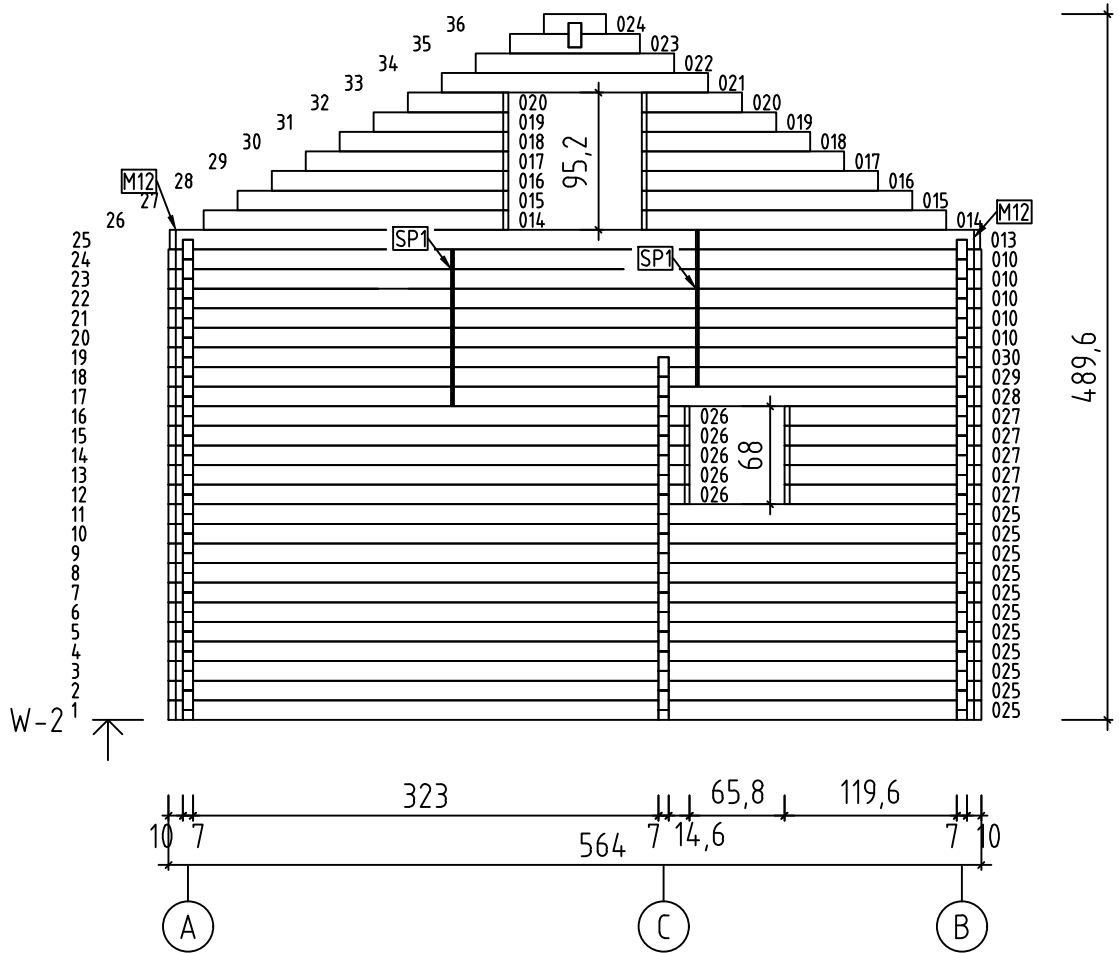
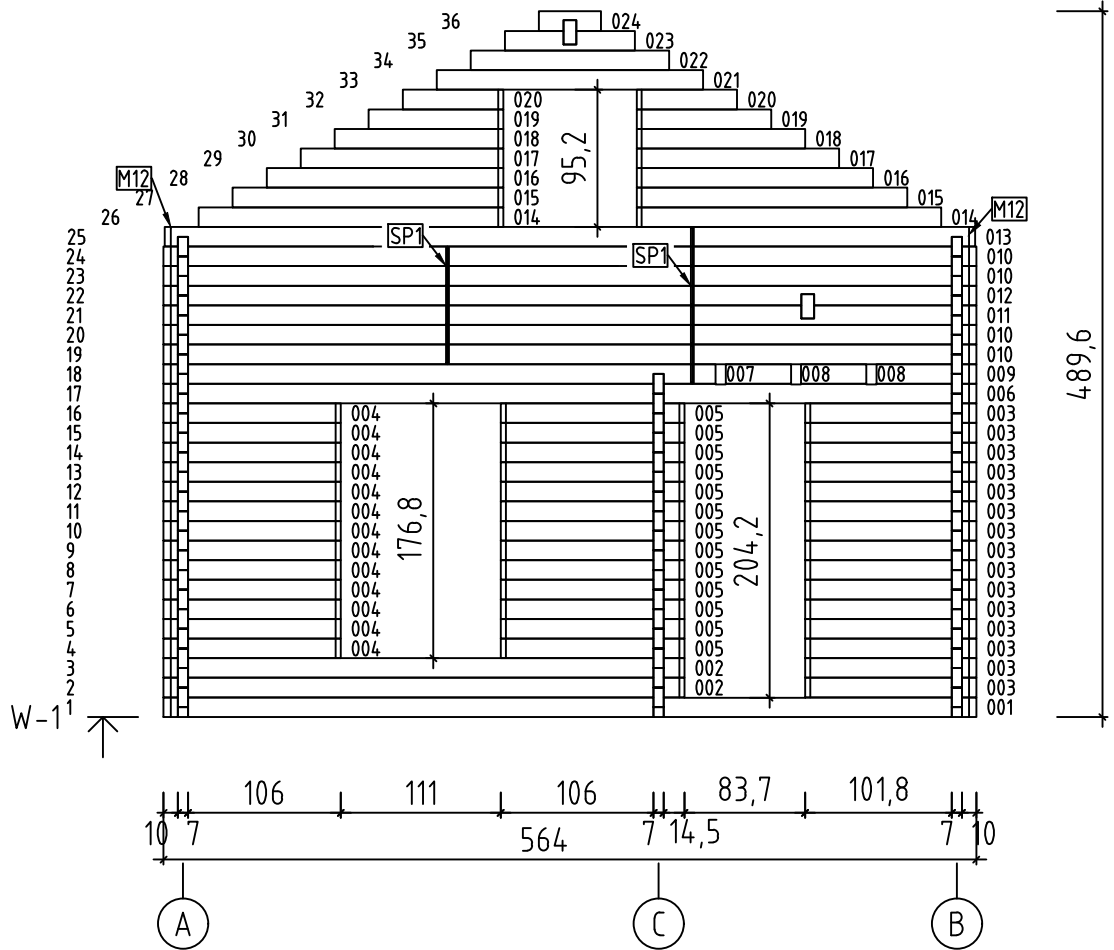

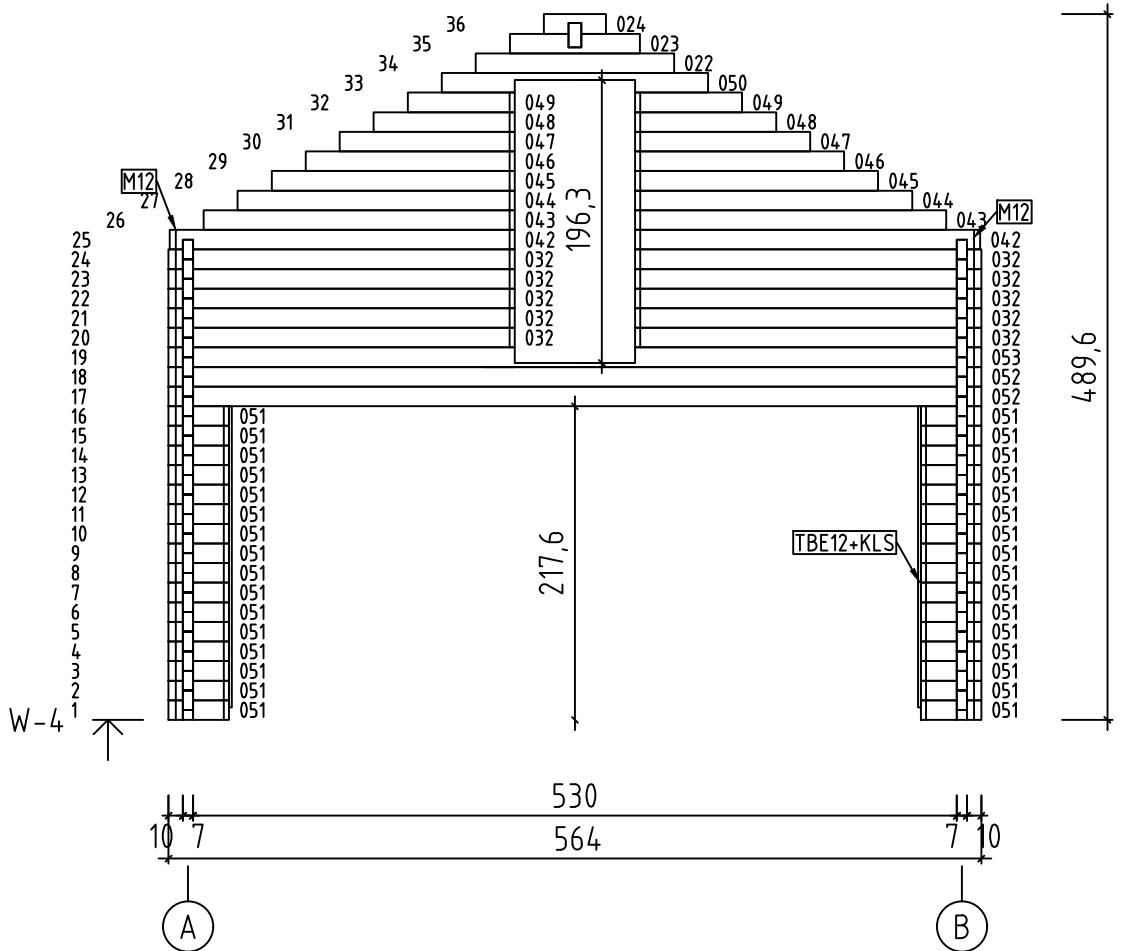
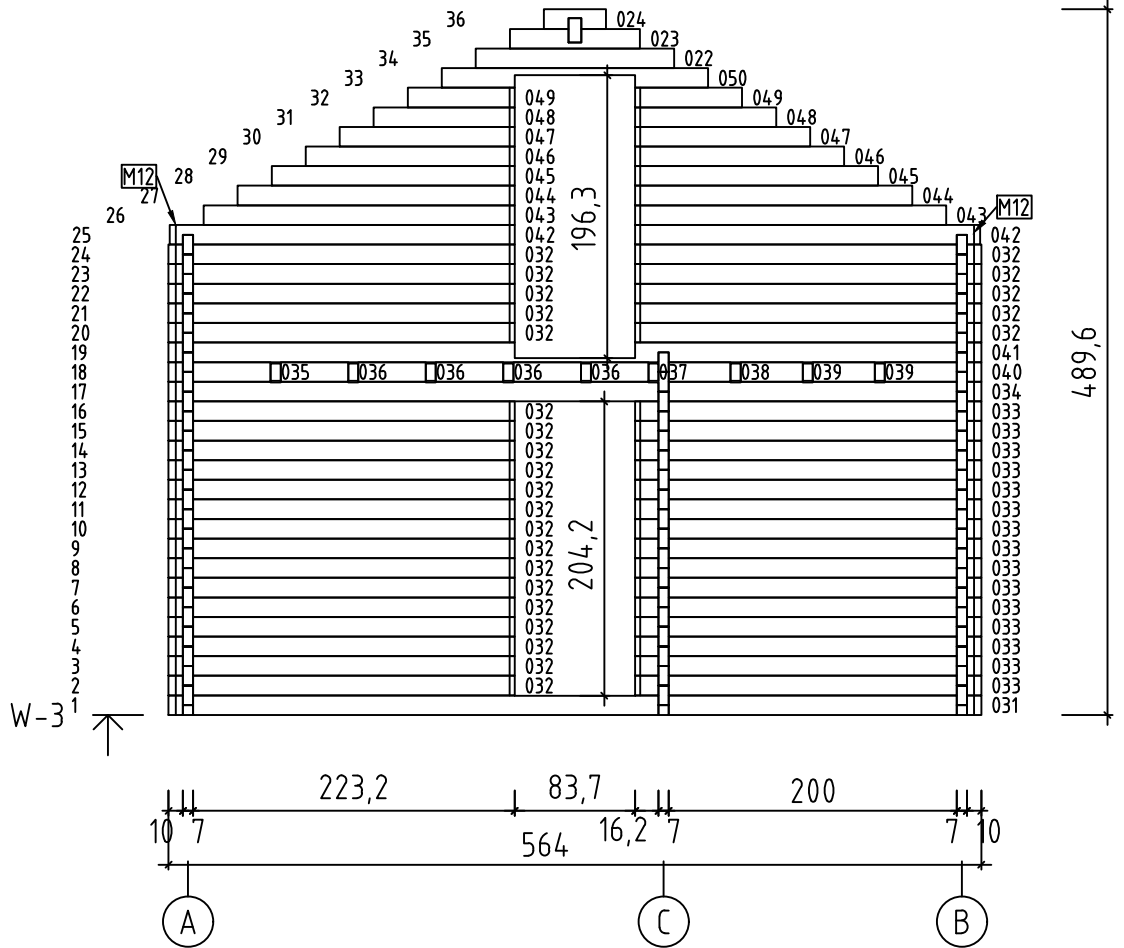

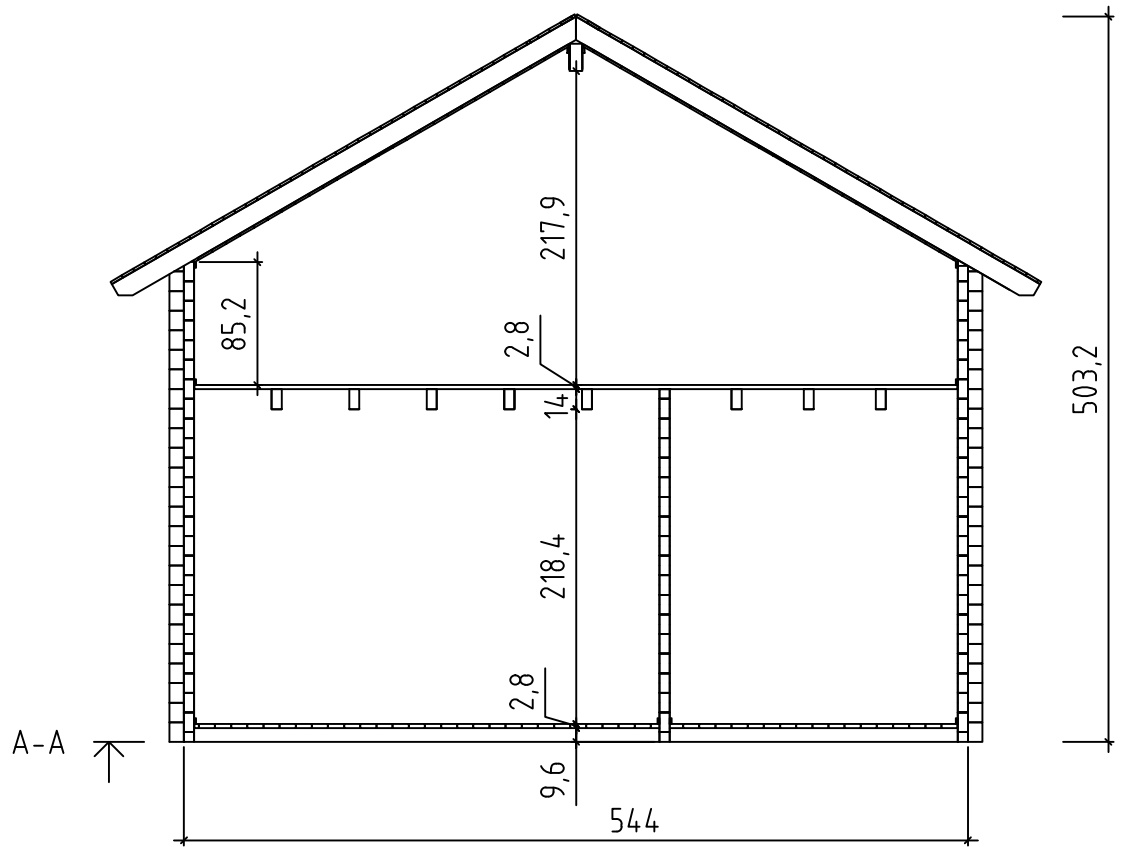
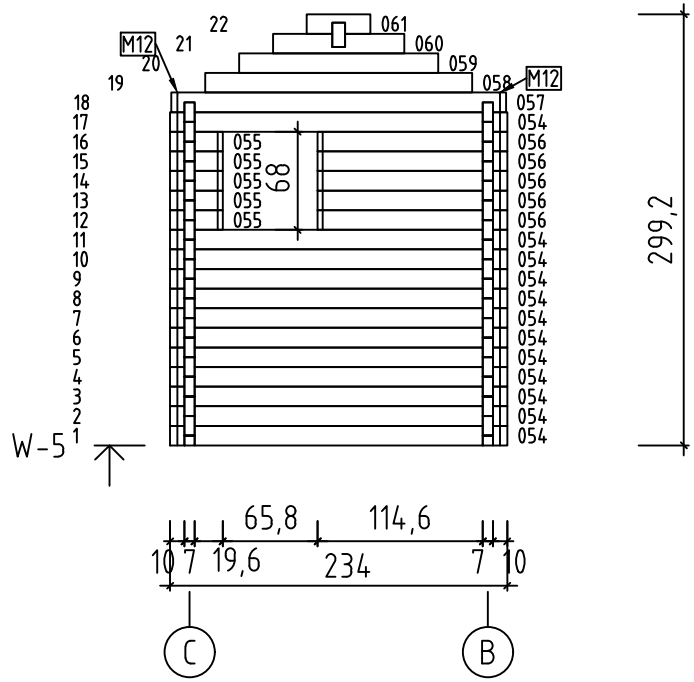

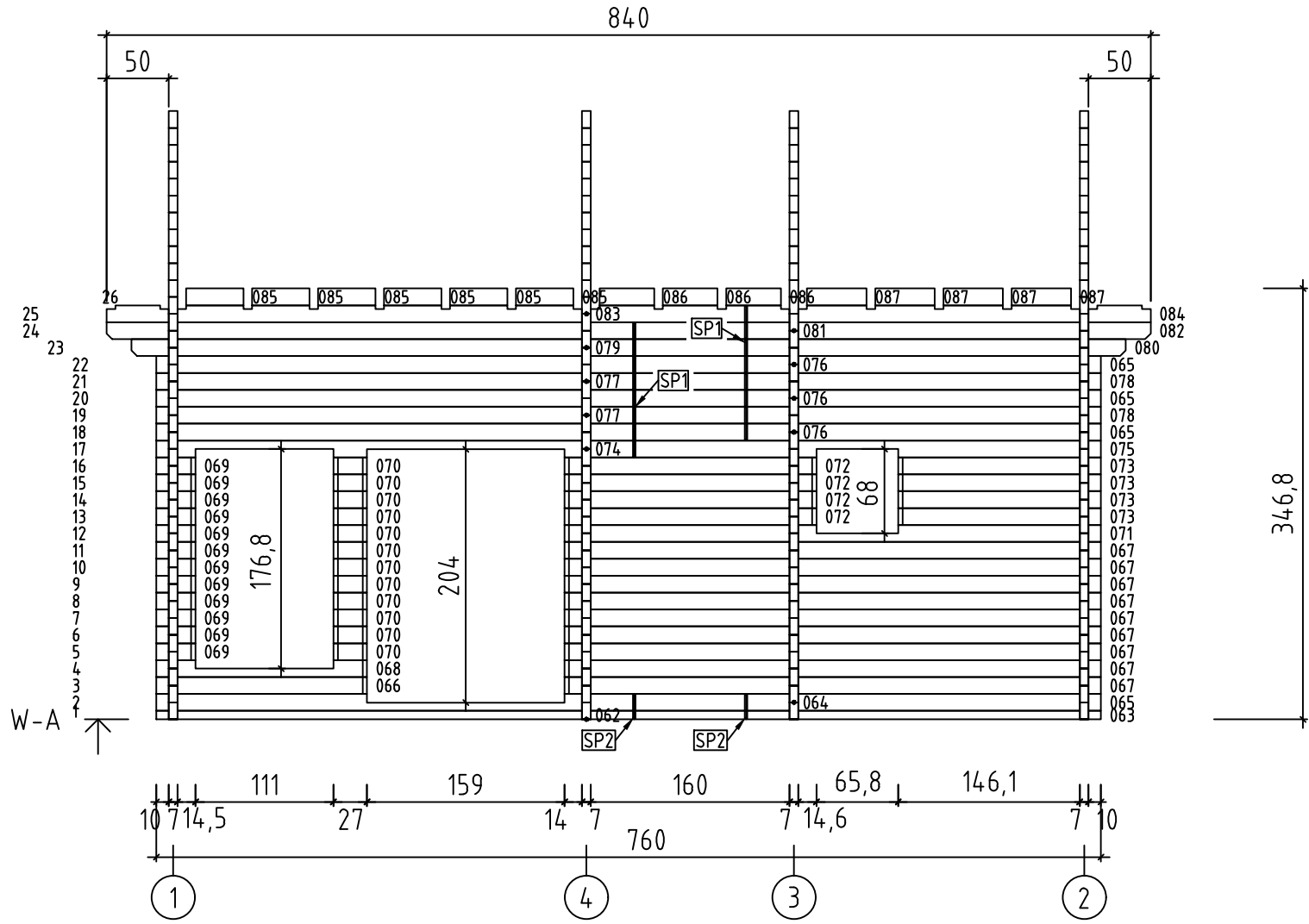

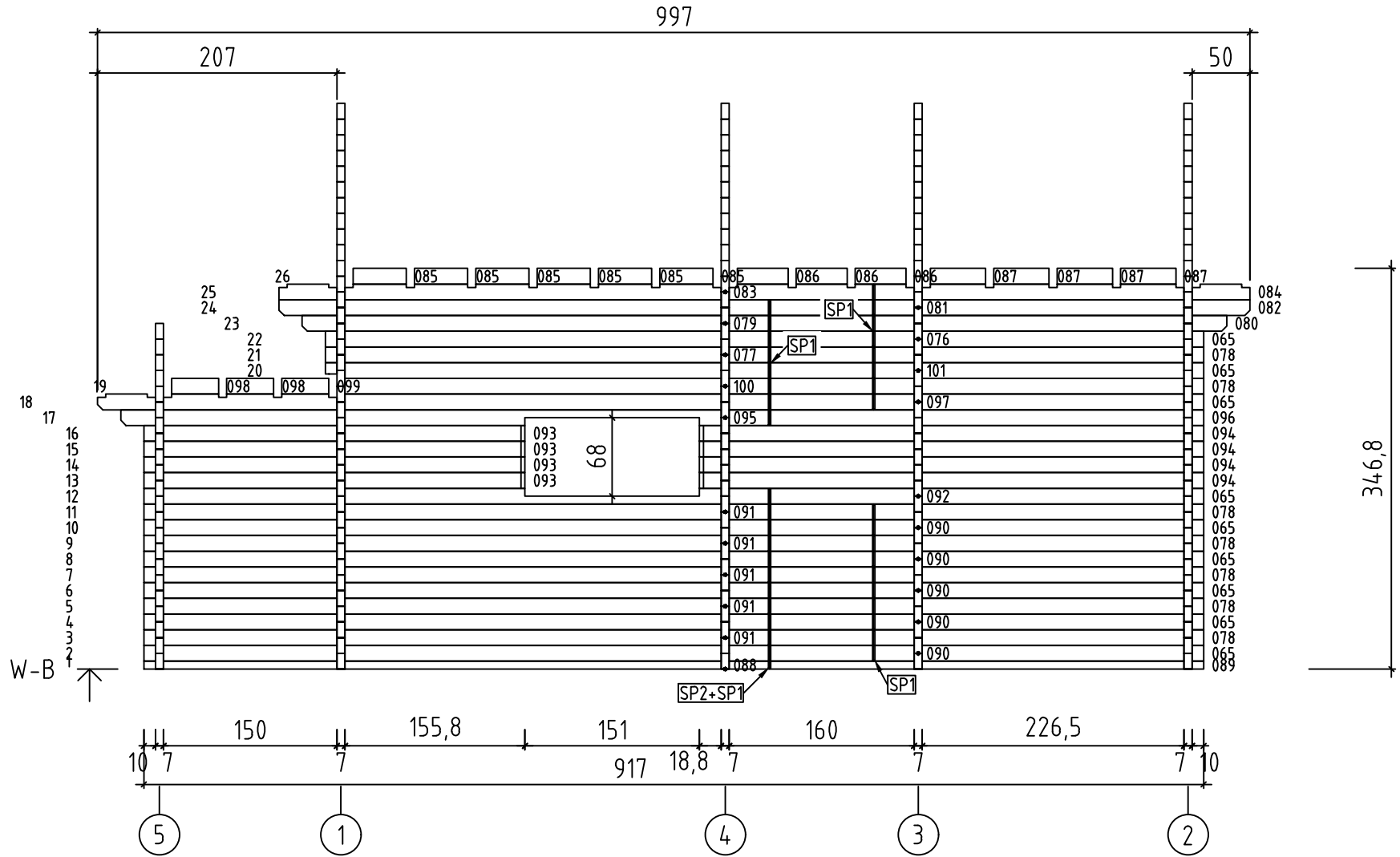

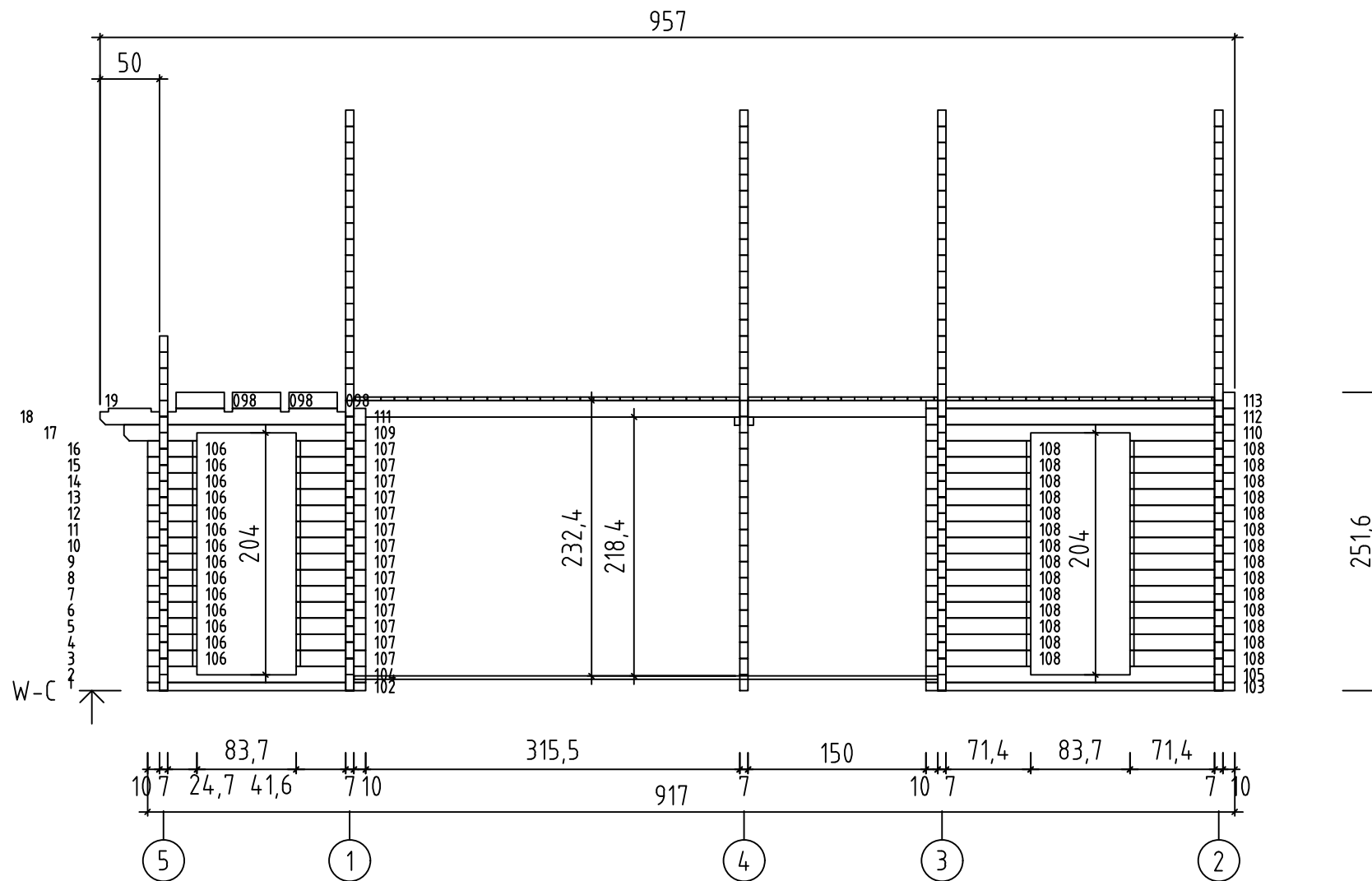

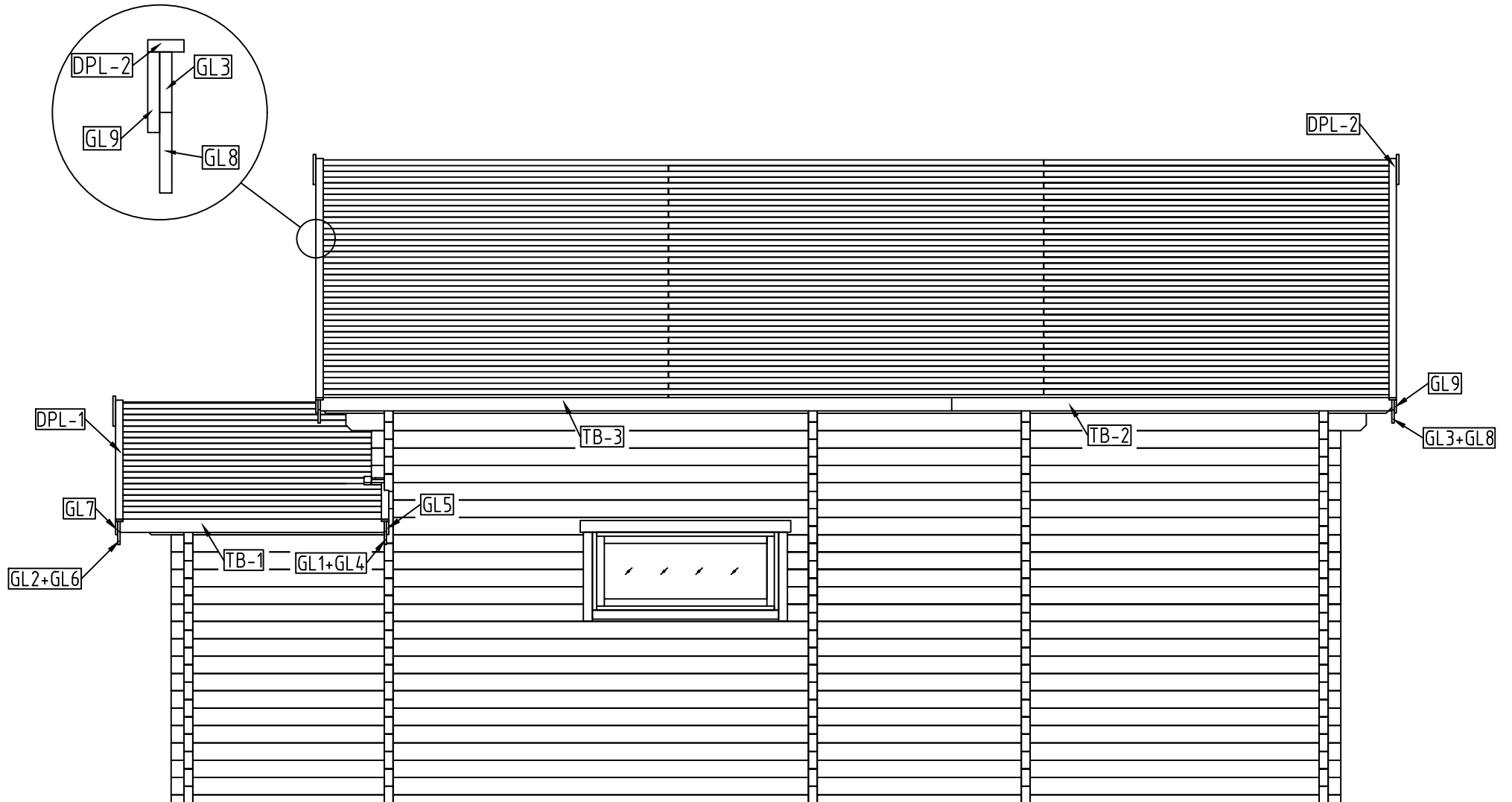

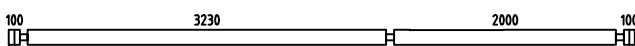
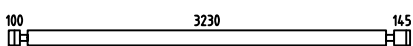
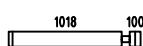
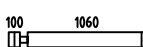
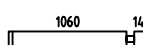
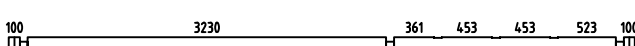
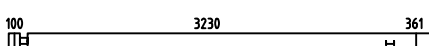

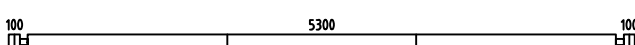
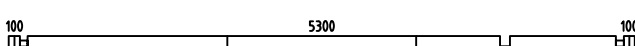
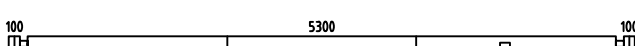
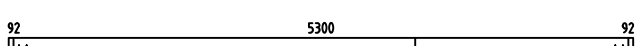
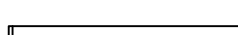
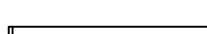
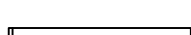

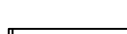
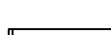







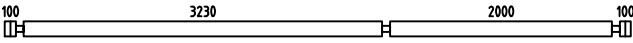
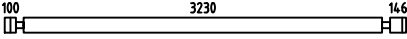
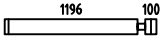
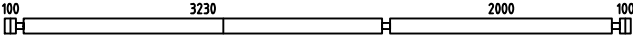
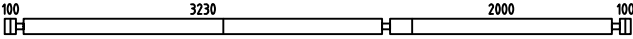
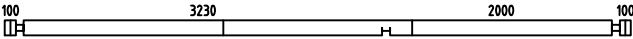
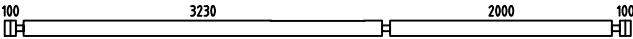
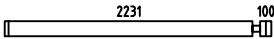
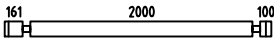
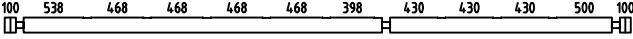







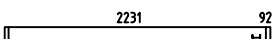
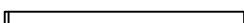





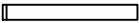
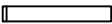



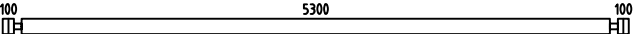
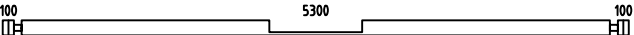
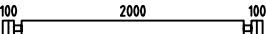

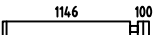
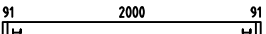

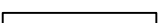

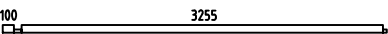

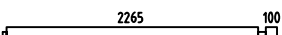
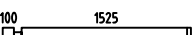

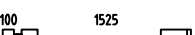



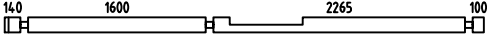
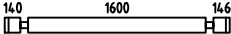
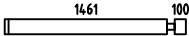
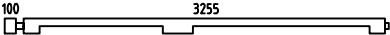
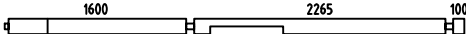
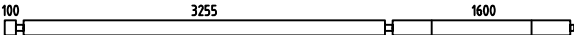
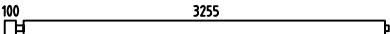
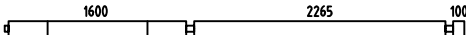
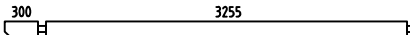
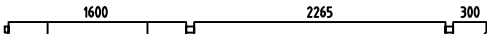
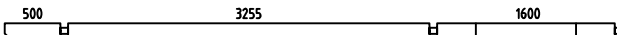
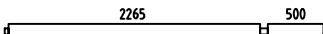
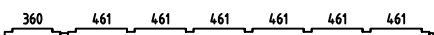
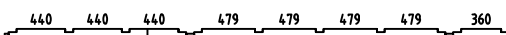



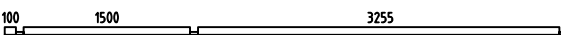
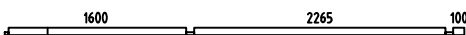
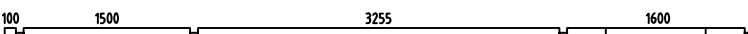

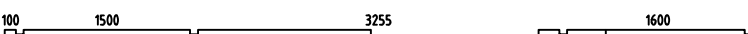
Pos	CEYLON, Art.No.706142 Piece list - Stückliste - Liste des pièces - Elementi - Stuklijst - Tükitabel	Q	P (mm)	L (mm)
001		1	70x136	5640
002		2	70x136	3615
003		15	70x136	1188
004		13	70x136	1230
005		13	70x136	1275
006		1	70x136	5640
007		1	70x136	3831
008		2	70x136	453
009		1	70x136	693
010		9	70x136	5640
011		1	70x136	5640
012		1	70x136	5640
013		2	70x136	5624
014		4	70x136	2113
015		4	70x136	1877
016		4	70x136	1641
017		4	70x136	1405
018		4	70x136	1169
019		4	70x136	933
020		4	70x136	697
021		2	70x136	1848
022		4	70x136	1376
023		4	70x136	904

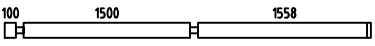
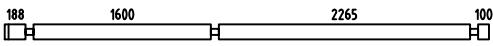
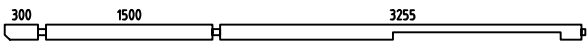
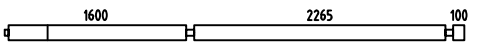
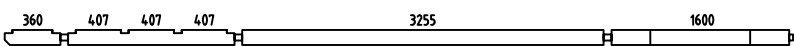

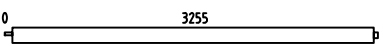
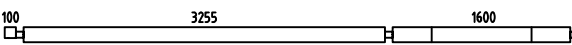
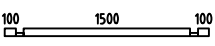
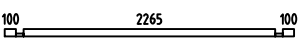
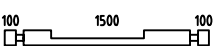
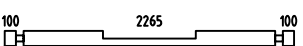
Pos	CEYLON, Art.No.706142 Piece list - Stückliste - Liste des pièces - Elementi - Stuklijst - Tükítabel	Q	P (mm)	L (mm)
024		4	70x136	432
025		11	70x136	5640
026		5	70x136	3616
027		5	70x136	1366
028		1	70x136	5640
029		1	70x136	5640
030		1	70x136	5640
031		1	70x136	5640
032		35	70x136	2401
033		15	70x136	2401
034		1	70x136	5640
035		1	70x136	708
036		4	70x136	468
037		1	70x136	398
038		1	70x136	500
039		2	70x136	430
040		1	70x136	670
041		1	70x136	5640
042		4	70x136	2393
043		4	70x136	2157
044		4	70x136	1921
045		4	70x136	1685
046		4	70x136	1449

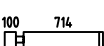
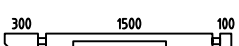
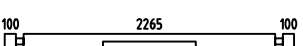
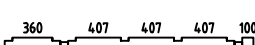
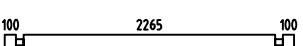
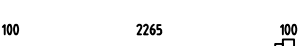



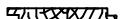

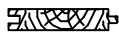



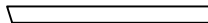
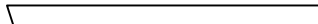
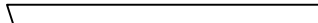

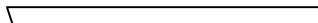

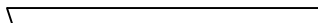
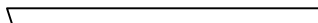



Pos	CEYLON, Art.No.706142 Piece list - Stückliste - Liste des pièces - Elementi - Stuklijst - Tükítabel	Q	P (mm)	L (mm)
047		4	70x136	1213
048		4	70x136	977
049		4	70x136	741
050		2	70x136	1848
051		32	70x136	420
052		2	70x136	5640
053		1	70x136	5640
054		12	70x136	2340
055		5	70x136	366
056		5	70x136	1316
057		1	70x136	2323
058		1	70x136	1852
059		1	70x136	1382
060		1	70x136	912
061		1	70x136	442
062		1	70x68	3460
063		1	70x68	4140
064		1	70x136	5130
065		13	70x136	2470
066		1	70x136	1695
067		9	70x136	4315
068		1	70x136	1695
069		12	70x136	315













Pos	CEYLON, Art.No.706142 Piece list - Stückliste - Liste des pièces - Elementi - Stuklijst - Tükitabel	Q	P (mm)	L (mm)
070		12	70x136	270
071		1	70x136	4315
072		4	70x136	2026
073		4	70x136	1631
074		1	70x136	3460
075		1	70x136	4140
076		4	70x136	5130
077		3	70x136	3460
078		9	70x136	4140
079		2	70x136	3660
080		2	70x136	4340
081		2	70x136	5530
082		2	70x136	2870
083		2	70x136	3860
084		2	70x136	4540
085		12	70x136	461
086		6	70x136	440
087		8	70x136	479
088		1	70x68	5030
089		1	70x68	4140
090		5	70x136	6700
091		5	70x136	5030
092		1	70x136	6700

Pos	CEYLON, Art.No.706142 Piece list - Stückliste - Liste des pièces - Elementi - Stuklijst - Tükítabel	Q	P (mm)	L (mm)
093		4	70x136	3298
094		4	70x136	4363
095		1	70x136	5230
096		1	70x136	4140
097		1	70x136	7100
098		5	70x136	407
099		1	70x136	407
100		1	70x136	3360
101		1	70x136	5130
102		1	70x68	1840
103		1	70x68	2605
104		1	70x136	1840
105		1	70x136	2605
106		14	70x136	417
107		14	70x136	586
108		28	70x136	884
109		1	70x136	2040
110		1	70x136	2605
111		1	70x136	2240
112		1	70x136	2605
113		1	70x136	2605
IAR3	Foundation - Fundament - Fondation - Fondamenta - Fundering - Immutatud alusraam 	8	45x96	5300
IAR1	Foundation - Fundament - Fondation - Fondamenta - Fundering - Immutatud alusraam 	7	45x96	3230

Pos	CEYLON, Art.No.706142 Piece list - Stückliste - Liste des pièces - Elementi - Stuklijst - Tükítabel	Q	P (mm)	L (mm)
IAR2	Foundation - Fundament - Fondation - Fundamenta - Fundering - Immutafud alusraam 	11	45x96	2000
IAR4	Foundation - Fundament - Fondation - Fundamenta - Fundering - Immutafud alusraam 	2	45x96	300
LT1	Mezzanine floor joists - Halbgeschoss balken - Solives de plancher mezzanine - Travi del pavimento mezzanino - Plaatduim scharnier - Laetafalad 500 3255 1600 2265 500 	1	90x190	8400
LT2	Mezzanine floor joists - Halbgeschoss balken - Solives de plancher mezzanine - Travi del pavimento mezzanino - Plaatduim scharnier - Laetafalad 500 1500 50 	1	90x190	2190
VT5	Mezzanine floor joists - Halbgeschoss balken - Solives de plancher mezzanine - Travi del pavimento mezzanino - Plaatduim scharnier - Vahelaetalad 	6	70x140	3935
VT6	Mezzanine floor joists - Halbgeschoss balken - Solives de plancher mezzanine - Travi del pavimento mezzanino - Plaatduim scharnier - Vahelaetalad 	3	70x140	3375
VT3	Mezzanine floor joists - Halbgeschoss balken - Solives de plancher mezzanine - Travi del pavimento mezzanino - Plaatduim scharnier - Vahelaetalad 	6	70x140	3255
VT4	Mezzanine floor joists - Halbgeschoss balken - Solives de plancher mezzanine - Travi del pavimento mezzanino - Plaatduim scharnier - Vahelaetalad 	3	70x140	2335
VT1	Mezzanine floor joists - Halbgeschoss balken - Solives de plancher mezzanine - Travi del pavimento mezzanino - Plaatduim scharnier - Vahelaetalad 	2	45x140	3255
VT2	Mezzanine floor joists - Halbgeschoss balken - Solives de plancher mezzanine - Travi del pavimento mezzanino - Plaatduim scharnier - Vahelaetalad 	2	45x140	2265
VT7	Mezzanine floor joists - Halbgeschoss balken - Solives de plancher mezzanine - Travi del pavimento mezzanino - Plaatduim scharnier - Vahelaetalad 	1	45x140	1600
VT11	Mezzanine floor joists - Halbgeschoss balken - Solives de plancher mezzanine - Travi del pavimento mezzanino - Plaatduim scharnier - Vahelaetalad 	1	45x70	5300
VT8	Mezzanine floor joists - Halbgeschoss balken - Solives de plancher mezzanine - Travi del pavimento mezzanino - Plaatduim scharnier - Vahelaetalad 	2	45x70	3230
VT10	Mezzanine floor joists - Halbgeschoss balken - Solives de plancher mezzanine - Travi del pavimento mezzanino - Plaatduim scharnier - Vahelaetalad 	1	45x70	3147
VT9	Mezzanine floor joists - Halbgeschoss balken - Solives de plancher mezzanine - Travi del pavimento mezzanino - Plaatduim scharnier - Vahelaetalad 	1	45x70	2000
SR1	Rafter - Dachsparren - Chevron - Trave - Dak spar - Sarikas 	40	70x140	3716
SR2	Rafter - Dachsparren - Chevron - Trave - Dak spar - Sarikas 	12	70x140	1814
STP	Ceiling boards - Deckenbrett - Voliges sous plafond - Tavole per piano soffitto - Dakhout - Laelaud 	56	111x15	3251
STP	Ceiling boards - Deckenbrett - Voliges sous plafond - Tavole per piano soffitto - Dakhout - Laelaud 	56	111x15	2261
STP	Ceiling boards - Deckenbrett - Voliges sous plafond - Tavole per piano soffitto - Dakhout - Laelaud 	56	111x15	1596
STP	Ceiling boards - Deckenbrett - Voliges sous plafond - Tavole per piano soffitto - Dakhout - Laelaud 	20	111x15	1496
HLL	Floor boards - Fussbodenbretter - Lame de plancher - Pavimento - Vloerhout - Põrandalaud 		137x28	613 m.
RB1	Roof boards - Dachbretter - Voliges - Perlina per tetto - Dakhout - Katuselaud 	42	90x18	5672

Pos	CEYLON, Art.No.706142 Piece list - Stückliste - Liste des pièces - Elementi - Stuklijst - Tükítabel	Q	P (mm)	L (mm)
RB2	Roof boards - Dachbretter - Voliges - Perlina per tetto - Dakhout - Katuselaud 	42	90x18	5600
RB3	Roof boards - Dachbretter - Voliges - Perlina per tetto - Dakhout - Katuselaud 	42	90x18	2800
RB4	Roof boards - Dachbretter - Voliges - Perlina per tetto - Dakhout - Katuselaud 	42	90x18	2728
RB5	Roof boards - Dachbretter - Voliges - Perlina per tetto - Dakhout - Katuselaud 	42	90x18	2070
FL-1	Floor fillet - Fussbodenleiste - Corniere de finition du plancher - Finitura per pavimento (battisco pa) - Vloerafwerkljst - Pörandaliist 		15x40	89 m.
LL-1	Ceiling fillet - Deckeleiste - Profil de finition sous plafond - Massello per soffitto - Dak afdekljst - Laeliist 		15x40	75 m.
KLS	Batten - Deckleiste - Profils de finition angles a l'exterieur - Asse - Afdek lijst - Katteliist 	2	18x70	2090
DPL-1	Roofing felt fillet - Dachpappenleiste - Baguette de fixation du feutre bitumeux - Asse per fissaggio guaina bituminosa - Afdekljst asfaltpapier - Katusepapiliist 	4	18x58	1875
DPL-2	Roofing felt fillet - Dachpappenleiste - Baguette de fixation du feutre bitumeux - Asse per fissaggio guaina bituminosa - Afdekljst asfaltpapier - Katusepapiliist 	4	18x58	3780
M12	Treaded rod m12 - Gewindestange m12 - Tige filetée m12 - Barra filettata passo m12 - Draadstang 12m - Keermelatt 	2		480
M12	Treaded rod m12 - Gewindestange m12 - Tige filetée m12 - Barra filettata passo m12 - Draadstang 12m - Keermelatt 	8		1435
M12	Treaded rod m12 - Gewindestange m12 - Tige filetée m12 - Barra filettata passo m12 - Draadstang 12m - Keermelatt 	10		2000
TB-1	Fascia board - Traufbrett - Bandeau de toit - Finitura lati tetto - Gevellijst - Räästalaud 	2	18x120	2070
TB-2	Fascia board - Traufbrett - Bandeau de toit - Finitura lati tetto - Gevellijst - Räästalaud 	2	18x120	3450
TB-3	Fascia board - Traufbrett - Bandeau de toit - Finitura lati tetto - Gevellijst - Räästalaud 	2	18x120	4950
TBE12	Fixing fillet - Fixierungsleiste - Profil de fixation - Massello di fissaggio - Bevestiging lijstwerk - Tenderliist 	2	28x34	2108
TBE6-1	Fixing fillet - Fixierungsleiste - Profil de fixation - Massello di fissaggio - Bevestiging lijstwerk - Tenderliist 	4	28x34	476
TBE6-2	Fixing fillet - Fixierungsleiste - Profil de fixation - Massello di fissaggio - Bevestiging lijstwerk - Tenderliist 	4	28x34	650
TBE6-3	Fixing fillet - Fixierungsleiste - Profil de fixation - Massello di fissaggio - Bevestiging lijstwerk - Tenderliist 	4	28x34	916
TBE6-4	Fixing fillet - Fixierungsleiste - Profil de fixation - Massello di fissaggio - Bevestiging lijstwerk - Tenderliist 	2	28x34	1564
TBE6-5	Fixing fillet - Fixierungsleiste - Profil de fixation - Massello di fissaggio - Bevestiging lijstwerk - Tenderliist 	2	28x34	1729
TBE6-1	Fixing fillet - Fixierungsleiste - Profil de fixation - Massello di fissaggio - Bevestiging lijstwerk - Tenderliist 	4	28x34	1700
TBE6-2	Fixing fillet - Fixierungsleiste - Profil de fixation - Massello di fissaggio - Bevestiging lijstwerk - Tenderliist 	6	28x34	1836

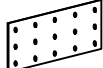
Pos	CEYLON, Art.No.706142 Piece list - Stückliste - Liste des pièces - Elementi - Stuklijst - Tükítabel	Q	P (mm)	L (mm)
TBE6-3	Fixing fillet - Fixierungsleiste - Profil de fixation - Massello di fissaggio - Bevestiging lijstwerk - Tenderlijst 	4	28x34	1990
GL1	Gable moulding - Giebelleiste - Planche de rive - Finitura per frontale e retro del tetto - Gevellijst - Viilulaud 	1	18x90	523
GL2	Gable moulding - Giebelleiste - Planche de rive - Finitura per frontale e retro del tetto - Gevellijst - Viilulaud 	2	18x90	1875
GL3	Gable moulding - Giebelleiste - Planche de rive - Finitura per frontale e retro del tetto - Gevellijst - Viilulaud 	4	18x90	3780
GL4	Gable moulding - Giebelleiste - Planche de rive - Finitura per frontale e retro del tetto - Gevellijst - Viilulaud 	1	18x120	471
GL5	Gable moulding - Giebelleiste - Planche de rive - Finitura per frontale e retro del tetto - Gevellijst - Viilulaud 	1	18x120	523
GL6	Gable moulding - Giebelleiste - Planche de rive - Finitura per frontale e retro del tetto - Gevellijst - Viilulaud 	2	18x120	1823
GL7	Gable moulding - Giebelleiste - Planche de rive - Finitura per frontale e retro del tetto - Gevellijst - Viilulaud 	2	18x120	1875
GL8	Gable moulding - Giebelleiste - Planche de rive - Finitura per frontale e retro del tetto - Gevellijst - Viilulaud 	4	18x120	3729
GL9	Gable moulding - Giebelleiste - Planche de rive - Finitura per frontale e retro del tetto - Gevellijst - Viilulaud 	4	18x120	3780
KL4	Lengthening bolt for threaded rod - Verlängerungsmutter für gewindestange - Manchon de raccordement de tige filetée - Bullone per barra filettata passo - Extensie moer voor draadstang - Jätkumutter keermelatile 	10		
KL1	Drive nut threaded rod - Einschlagmutter für gewindestange - Écrou a frapper pour tige filetée - Dado guida per barra filettata - Aandrijfmoer / aanslagmoer voor draadstang - Löökmitter keermelatile 	10		
KL2	Nut for threaded rod - Mutter für gewindestange - Écrou pour tige filetée - Dado per barra filettata - Moer voor draadstang - Mutter keermelatile 	10		
KL3	Plain washer threaded rod - Unterlegscheibe für gewindestange - Rondelle plate pour tige filetée - Rondella per barra filettata - Sluiring voor draadeind - Seib keermelatile 	10		
HS12	Screw for gable segment - Schrauben für deckblatt - Vis pour fixation losange de finition - Viti x frontali tetto - Schroef voor gevelpunt segment - Kruvi rombile 	6	3.5x35	
HS11	Screw for corner batten - Schrauben für deckleisten - Vis de fixation profils de finition angles a l'exterieur - Viti per stecca d'angolo - Schroef voor afdeklaf - Kruvi nurgaliistule 	10	3.5x50	
HS25	Screw for floor - Schrauben für fussbodenbretter - Vis pour plancher - Viti per le perline del pavimento - Schroef voor vloerhout - Kruvi pörandale 	1620	3.5x50	
HS32	Screw for fascia boards - Schrauben für traufbretter - Vis pour fixation bandeau de toit - Viti x striscia del tetto - Schroef voor gevellijst - Kruvi räästalauale 	108	3.5x50	
HS84	Screw for fixing fillet of door and window - Schrauben für fixierungsleiste - Vis pour profil vertical de fixation pour ouvertures des fenetres et portes - Viti per massello di fissaggio - Schroeven voor bevestiging van deur en raam lijsten - Kruvi tenderlijstudele 	138	3.5x50	
HS16	Screw for gable moulding - Schrauben für giebelleiste - Vis pour fixation planche de rive - Vite per fissare finiture davanti e dietro del tetto - Schroef voor gevellijst - Kruvi viilulauale 	144	3.5x50	
NFD	Screw for roofing felt fillet - Schrauben für dachpappenleiste - Vis pour fixation baguette de fixation feutre bitumeux - Vite per massellino del feltro del tetto - Schroef voor asfaltpaier afdekljst - Kruvi kald-katusepapiistule 	52	4x40	
HS73	Screw for metal corner - Holzschraube für metallwinkel - Vis de fixation des cornieres en métal - Viti per fissare suadretta di metallo di giunzione - Schroef voor metalen hoek - Kruvi nurgikule 	208	4x40	
HS89	Screw for loft support - Schraube für dachbefestigung - Vis pour cornière de renfort de fixation - Viti per supporto del soppalco - Schroef voor dakbevestiging - Kruvi vahelae kandurlijstule 	150	5x100	

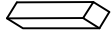
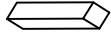
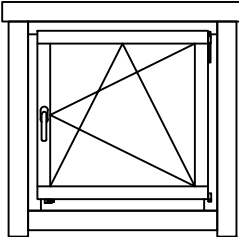
Pos	CEYLON, Art.No.706142 Piece list - Stückliste - Liste des pièces - Elementi - Stuklijst - Tükítabel	Q	P (mm)	L (mm)
HS39	Screw for foundation - Schrauben zur Befestigung Fundament - Vis de fixations des poutrelles de fondations - Viti x fundamenta - Schroef voor fundering - Kruvi alusraamile 	108	5x90	
HS48	Screw for pos. 085-087; 098 - Schrauben für pos. 085-087; 098 - Vis pour pos. 085-087; 098 - Viti per fissare elemento vedi figura in pos. 085-087; 098 - Schroef voor pos. 085-087; 098 - Kruvi pos. 085-087; 098 	64	6x180	
HS44	Screw for rafter - Schrauben für Dachsparren - Vis pour chevron - Vite per trave - Schroef voor dakspar - Kruvi sarikatele 	104	6x180	
HS44	Screw for rafter - Schrauben für Dachsparren - Vis pour chevron - Vite per trave - Schroef voor dakspar - Kruvi sarikatele 	6	8x220	
MS	Screw for doorstep - Schrauben für Schwelle - Vis pour fixation barre de seuil - Vite per soglia della porta - Schroef voor deurdorpel - Kruvi lävepakule 	15	4.5x65	
SH70	Hammer block - Schlagholz - Calle de frappe - Blocco di legno da usare come cuscinetto quando si usa il martello - Slagklos - Löögiklots 	3		
NFF	Zn nail for floor fillet - Zn Nägel für Fussbodenleiste - Pointe pour cornière de finition du plancher - Chiodi x fissaggio pavimento - Spijker(nagel) voor vloer afdekljst - Nael pörandaliistule 	178	1.4x40	
NFF	Zn nail for ceiling fillet - Zn Nägel für Deckleiste - Pointe pour profil de finition sous plafond - Chiodi zincati per massellini del soffitto - Spijker(nagel) voor plafond afdekljst - Nael laeliistule 	150	1.4x40	
NF2	Zn nail for roof - Zn Nägel für Dachbretter - Pointe pour fixation voliges de toit - Chiodi x perline tetto - Spijker(nagel) voor dakhout - Nael katuselauale 	2110	2.1x50	
NF2	Zn nail for ceiling boards - Zn Nägel für Deckenbretter - Clous pour voliges sous plafonds - Chiodo per il tavolo del soffitto - Spijkers voor plafondplaat - Nael laelauale 	1016	2.1x50	
KR2	Metal corner - Metallwinkel - Corniere en métal - Angolo di metallo - Metalen hoek - Nurgik 	26		
ORZ	Montage set for doors and windows - Montage-set für Türen und Fenster - Jeu de montage portes et fenetres - Set di assemblaggio per porte e finestre - Montage set voor deur en raam - Orthez akna ja ukse montaaživahendid	1		
GS	Gable segment - Deckblatt - Losange de finition - Decorazione in legno x frontale tetto - Gevelpunt segment - Romb 	3		
SP2	Hidden fixing - Holzdübel - Tourillon bois - Fissaggio a scomparsa - Verloren kop spijker - Salapulk 	3		190
SP1	Hidden fixing - Holzdübel - Tourillon bois - Fissaggio a scomparsa - Verloren kop spijker - Salapulk 	42		260
TRU	Stairs - Treppen - Escaliers - Scala - Trappen - Trepp	1		
	Window - Fenster - Fenetre - Finestra - Raam - Aken 916x916 2+ A.0P.K 	2		

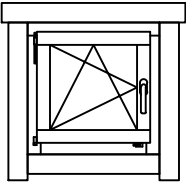
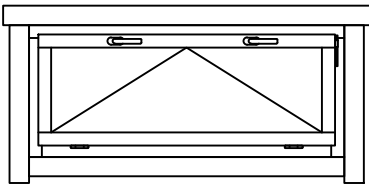
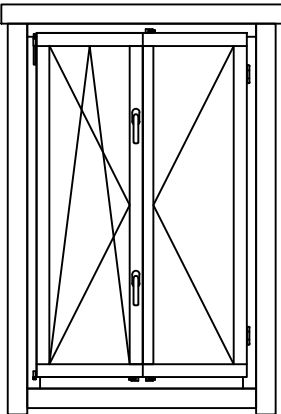
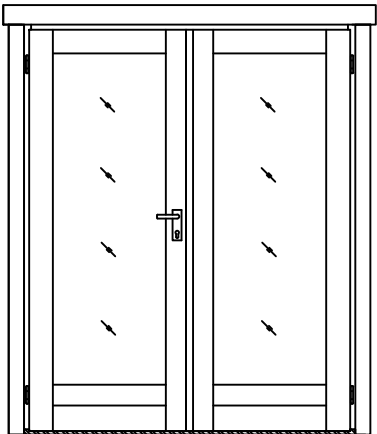
Pos	CEYLON, Art.No.706142 Piece list - Stückliste - Liste des pièces - Elementi - Stuklijst - Tükítabel	Q	P (mm)	L (mm)
	Window - Fenster - Fenetre - Finestra - Raam - Aken <div style="text-align: right;">650x650 2+ A.0V.cK</div> 	3		
	Window - Fenster - Fenetre - Finestra - Raam - Aken <div style="text-align: right;">1500x650 2+ A.0Ü.bK</div> 	1		
	Window - Fenster - Fenetre - Finestra - Raam - Aken <div style="text-align: right;">1100x1729 2+ TA.0V.bK</div> 	2		
	Door - Tür - Porte - Porte - Deur - Uks <div style="text-align: right;">1580x2000 2+ TU.10V.bK</div> 	1		

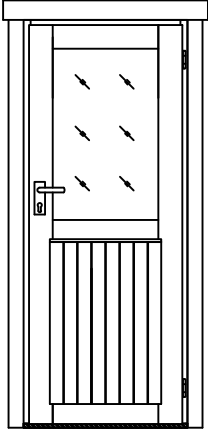
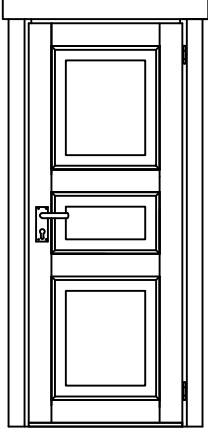
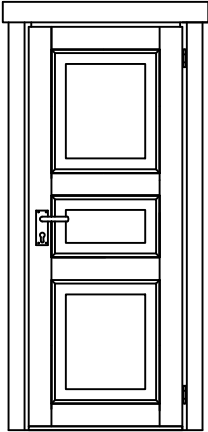
Pos	CEYLON, Art.No.706142 Piece list - Stückliste - Liste des pièces - Elementi - Stuklijst - Tükitabel	Q	P (mm)	L (mm)
	Door - Tür - Porte - Porte - Deur - Uks <div style="text-align: right;">827x2000 2+ U.20P.bK</div> 	1		
	Door - Tür - Porte - Porte - Deur - Uks <div style="text-align: right;">827x1933 U.3TP</div> 	1		
	Door - Tür - Porte - Porte - Deur - Uks <div style="text-align: right;">827x2000 U.3TP.b</div> 	1		

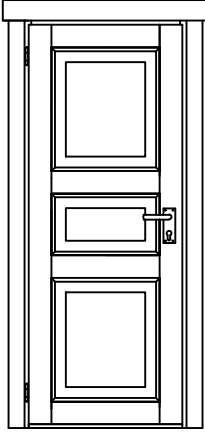
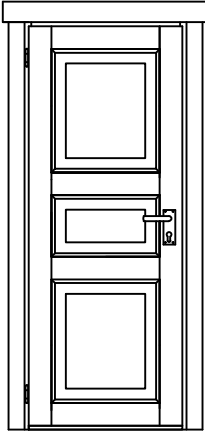
Pos	CEYLON, Art.No.706142 Piece list - Stückliste - Liste des pièces - Elementi - Stuklijst - Tükitabel	Q	P (mm)	L (mm)
	Door - Tür - Porte - Porte - Deur - Uks <div style="text-align: right;">827x1933 U.3TV</div> 	1		
	Door - Tür - Porte - Porte - Deur - Uks <div style="text-align: right;">827x2000 U.3TV.b</div> 	2		

