

*Art.No. 700702*

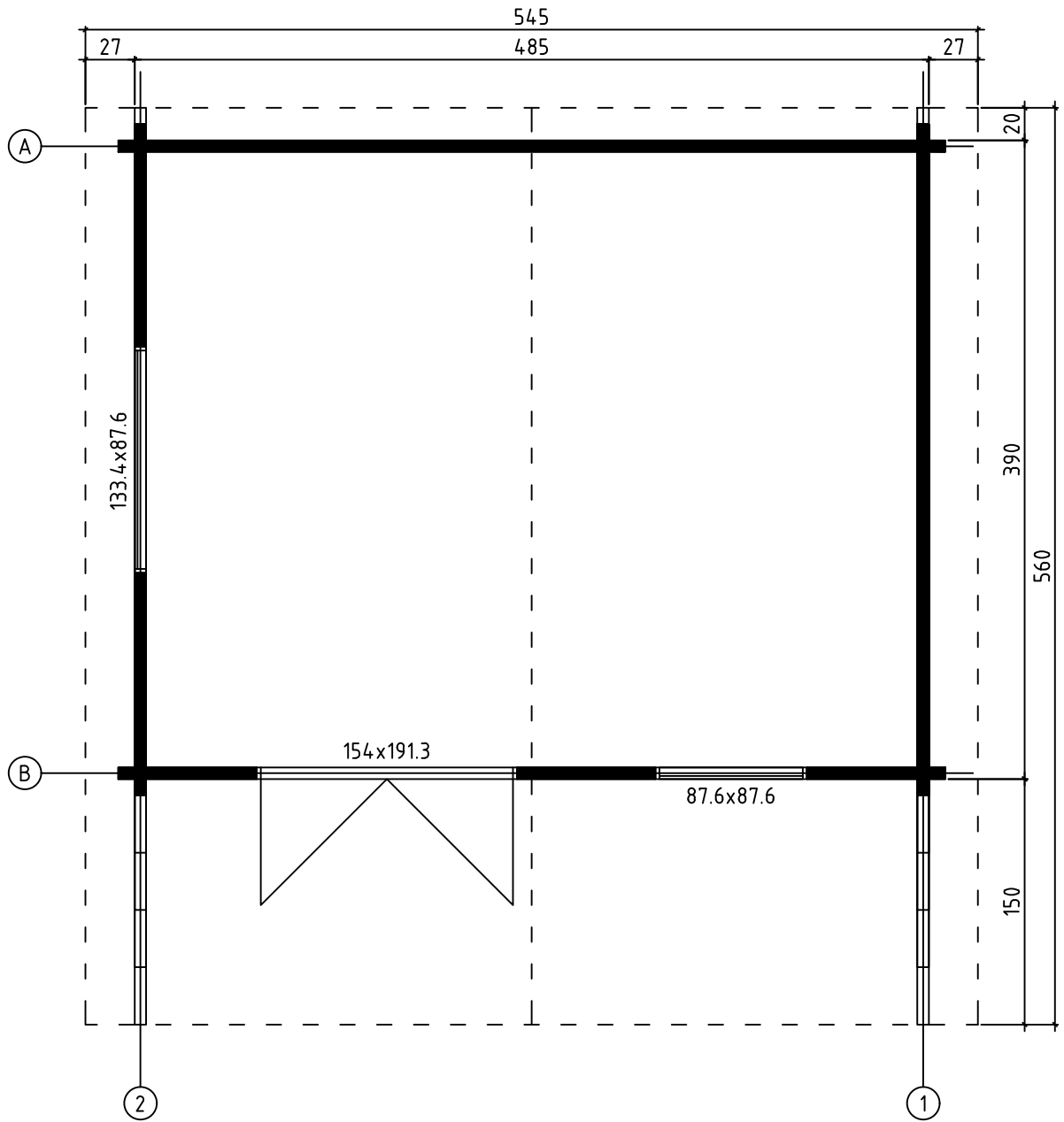

GROUNDPLAN - GRUNDPLAN - PLAN DE MASSE - PLANIMETRIA



FOUNDATION - FUNDAMENT - FONDAATION - FONDAMENTA

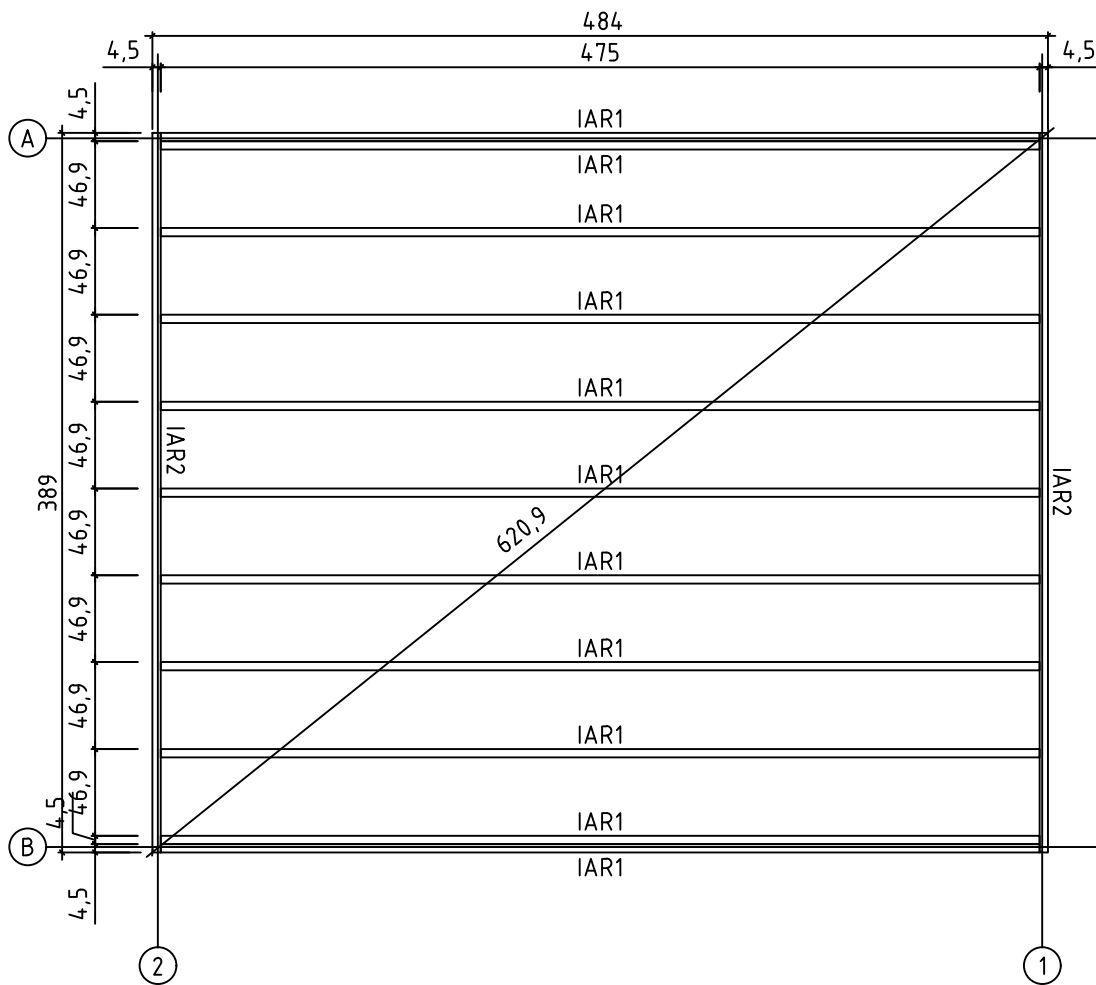

FLOOR BOARDS - FUSSBODENBRETTER - LAME DE PLANCHER - PAVIMENTO

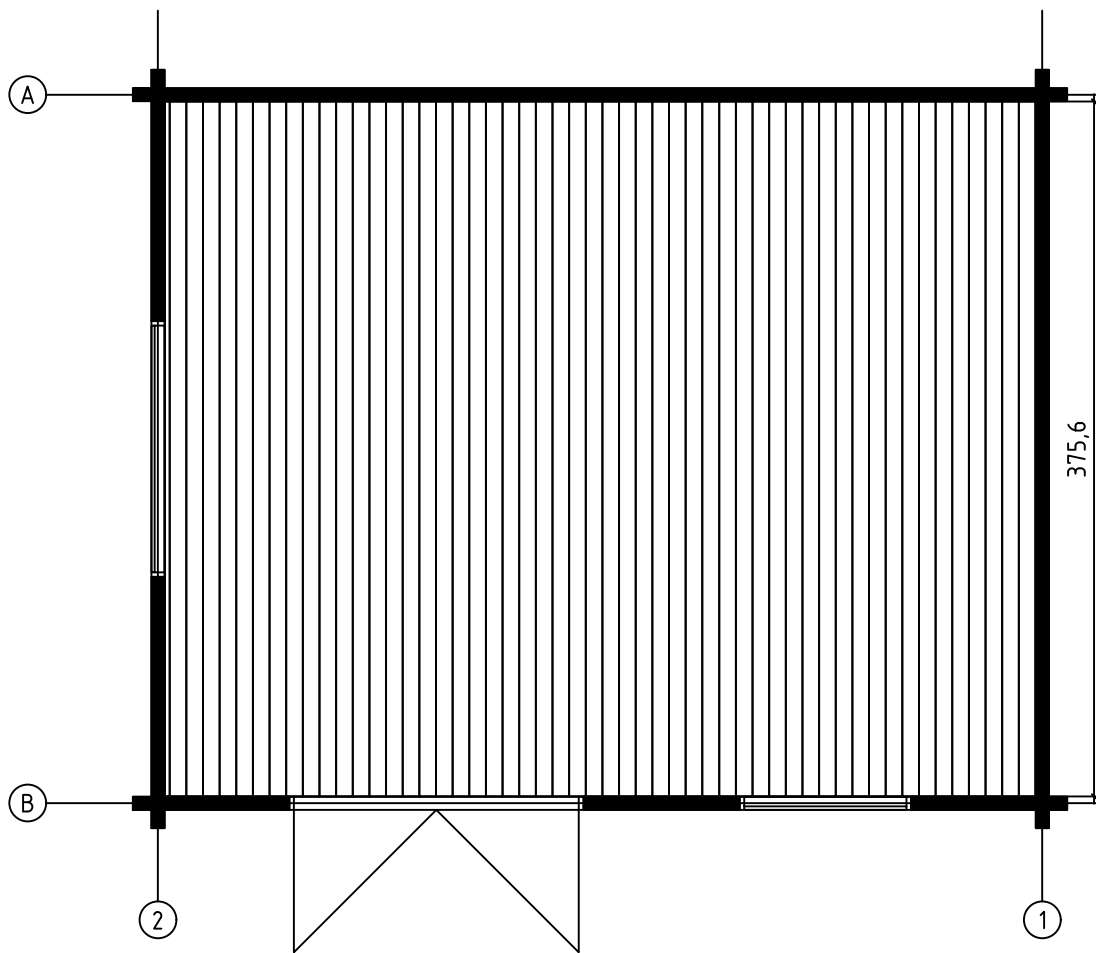

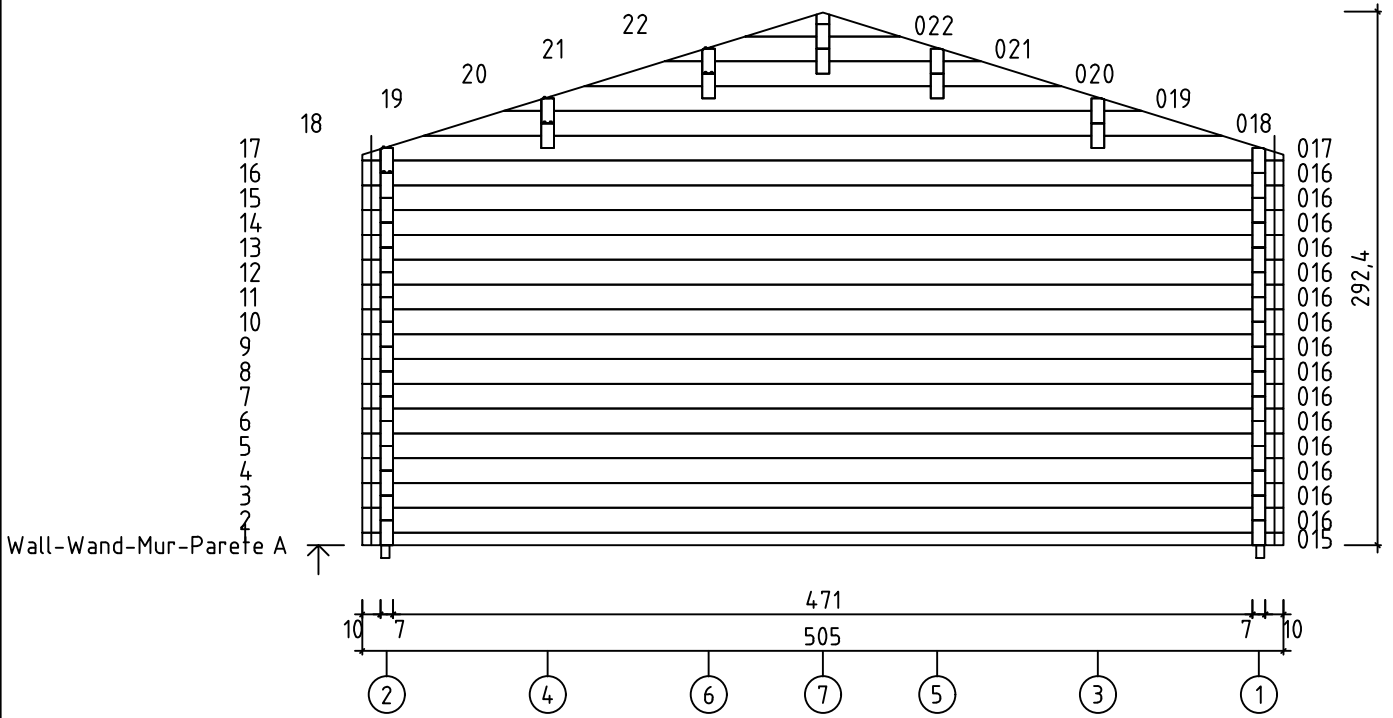
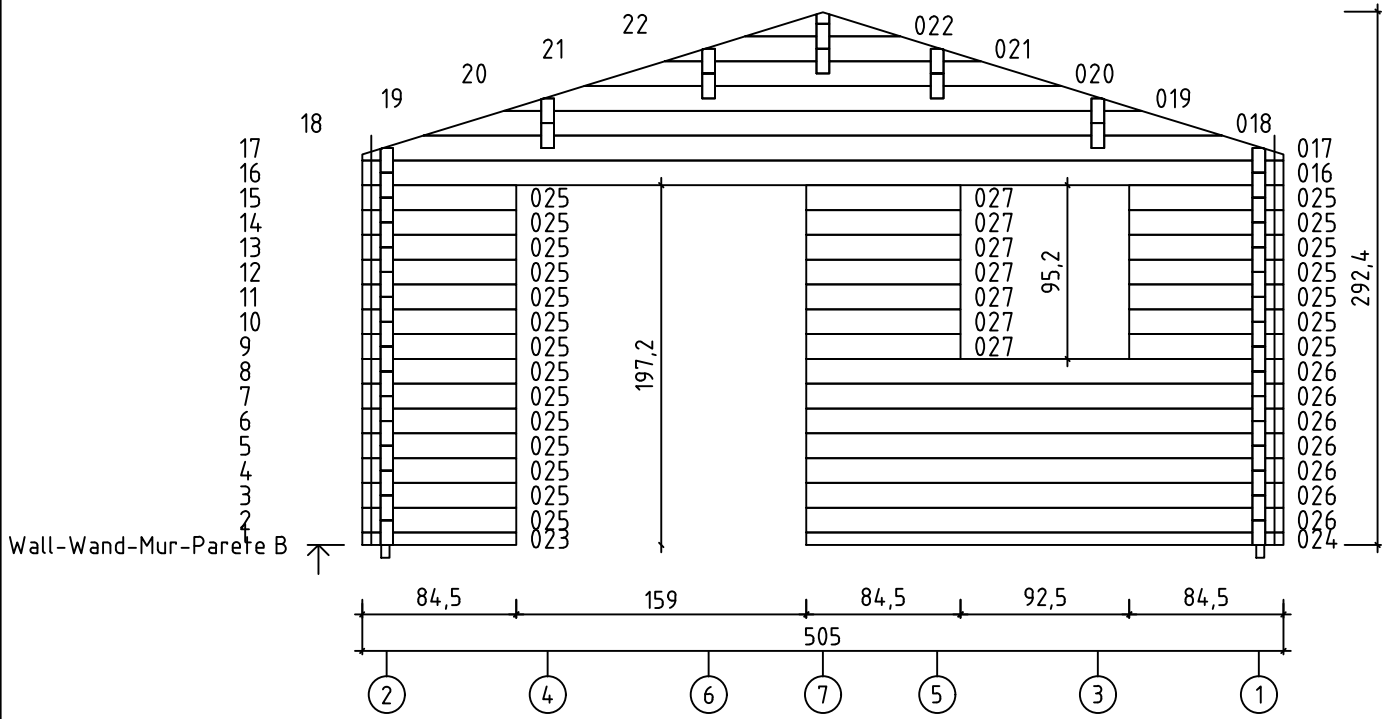

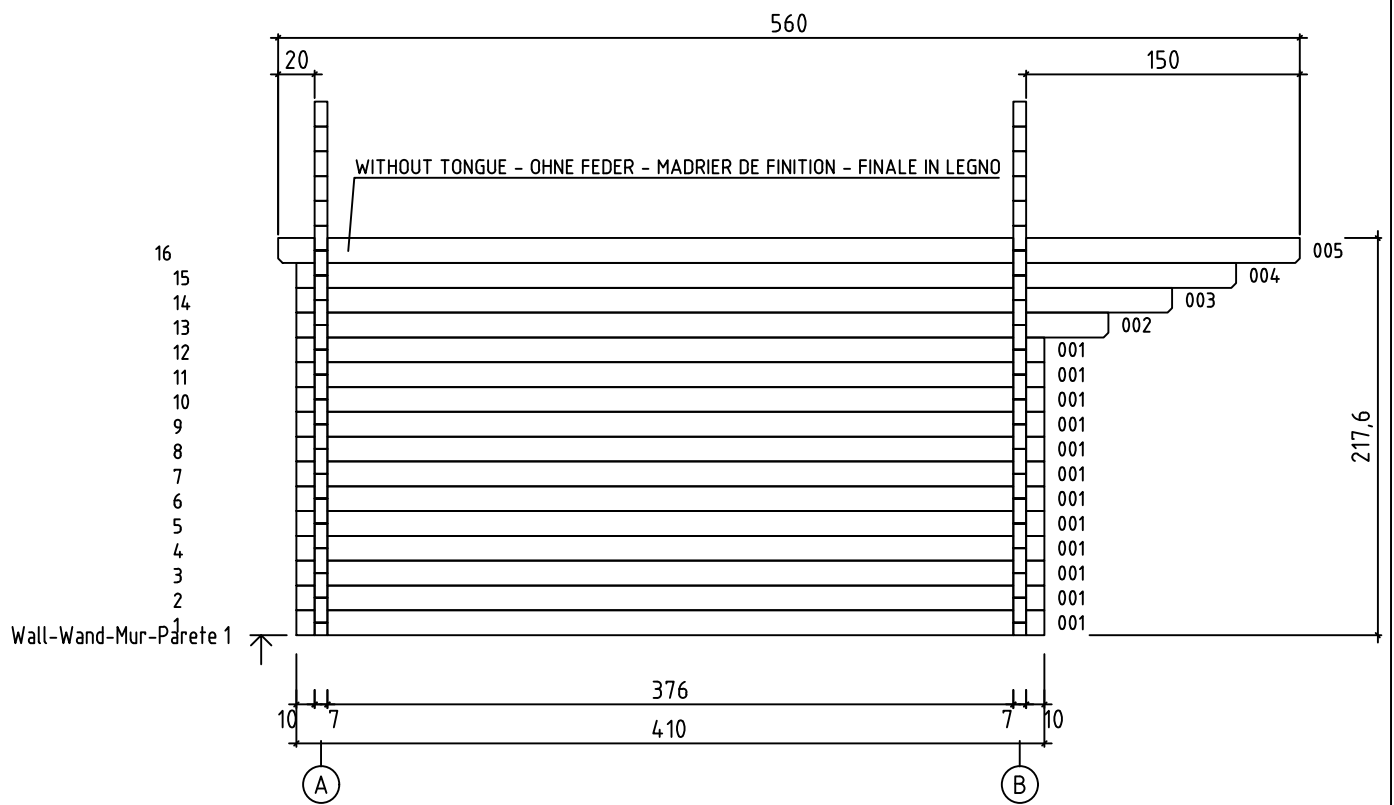
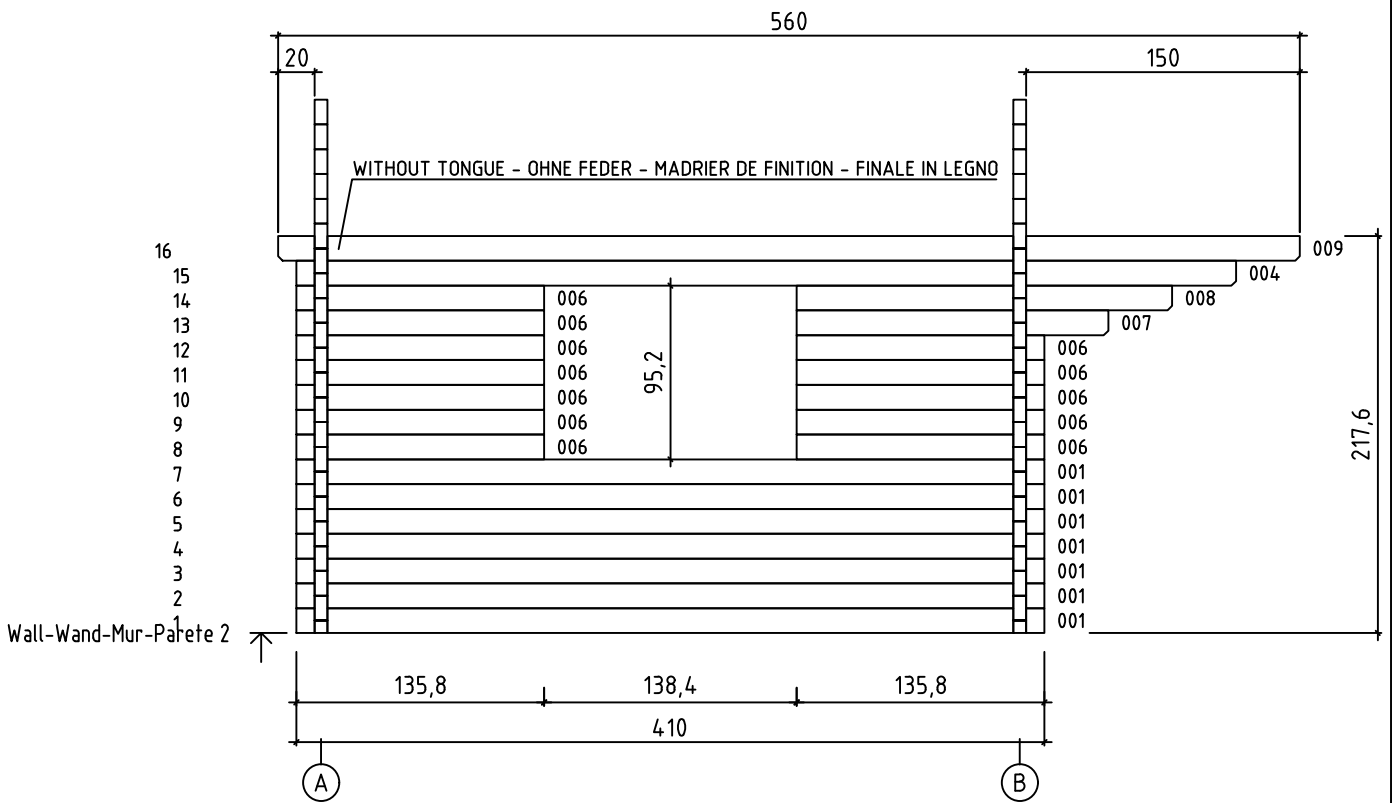

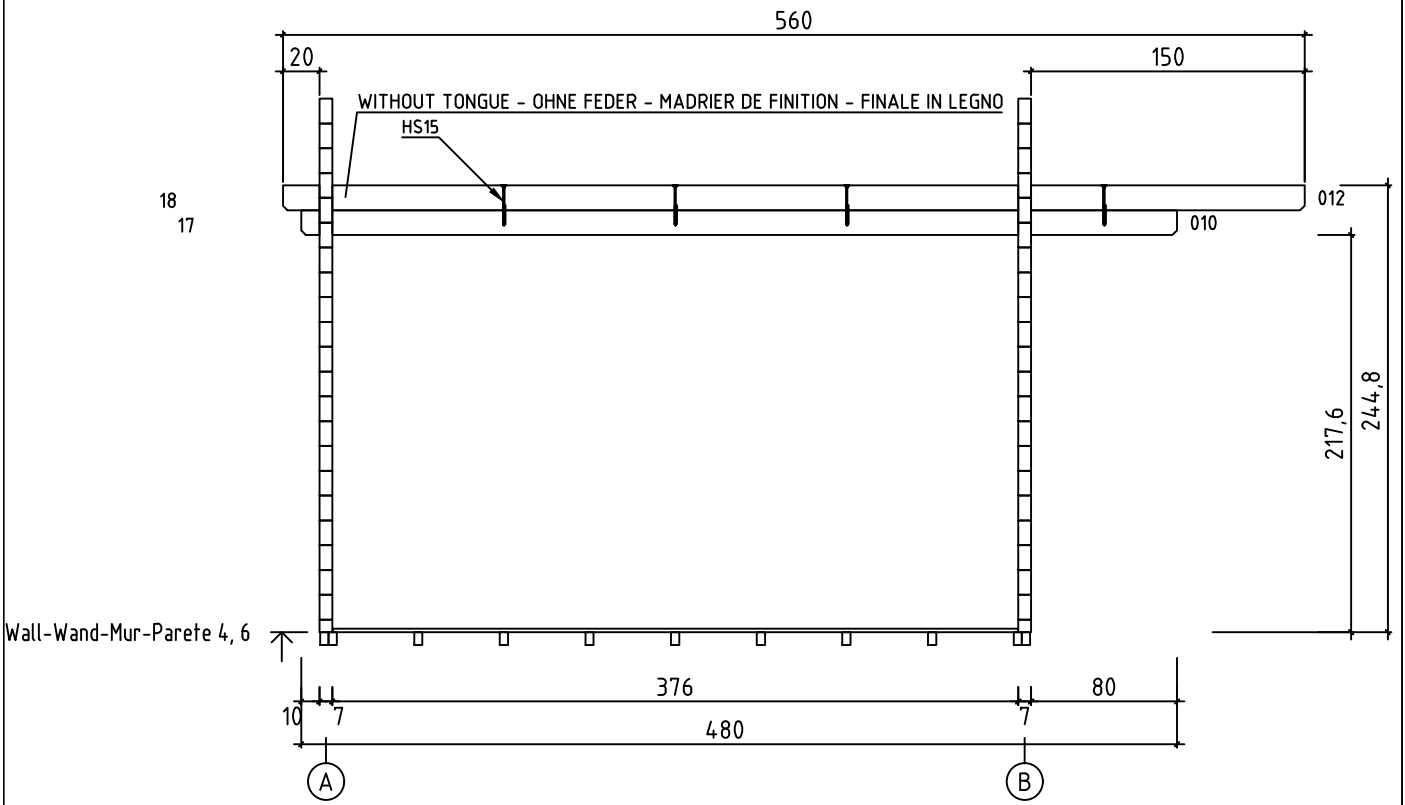
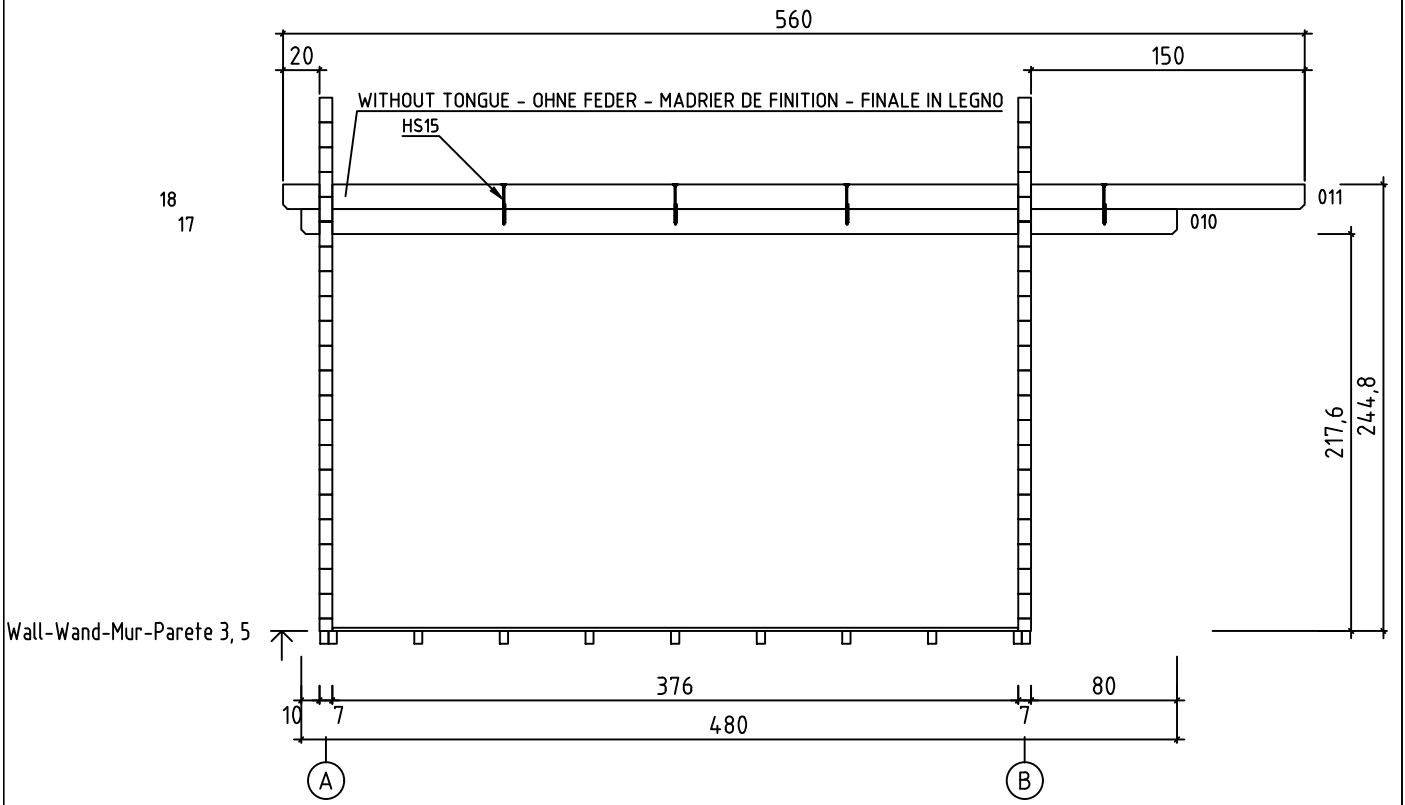



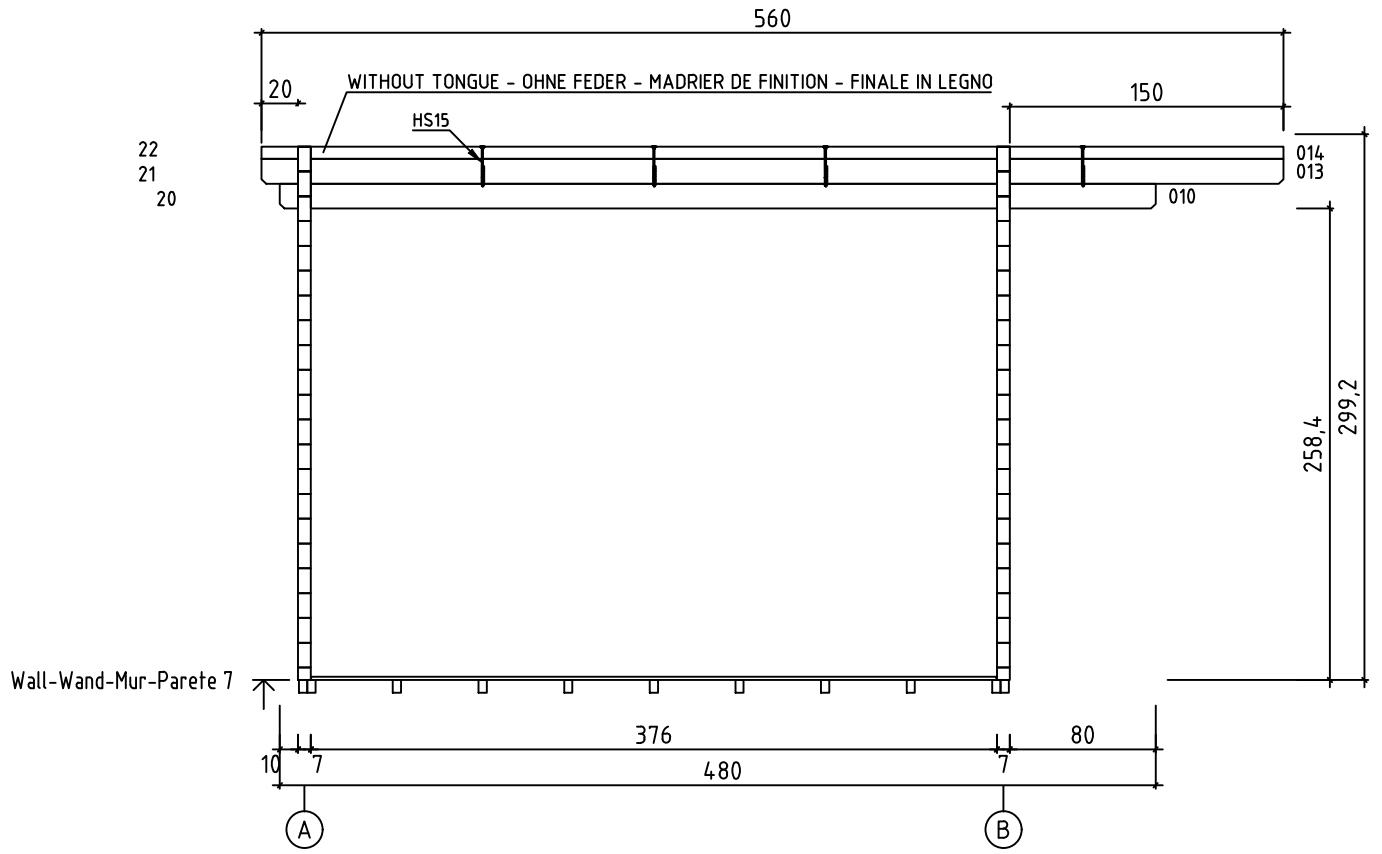

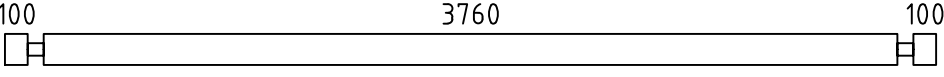
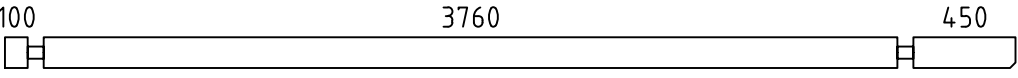
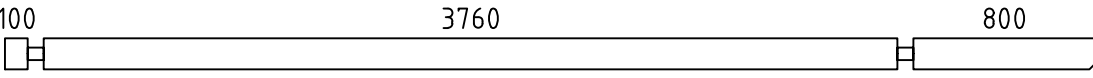
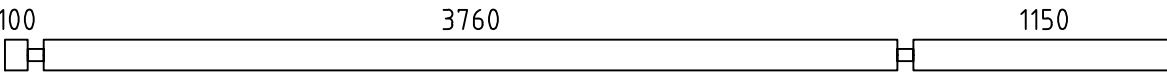
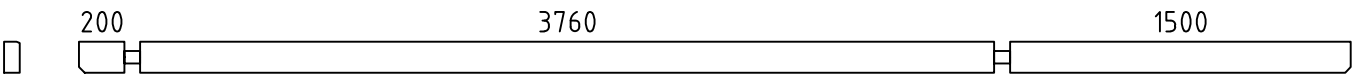
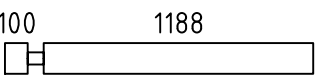
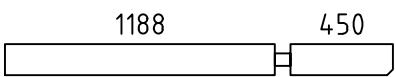

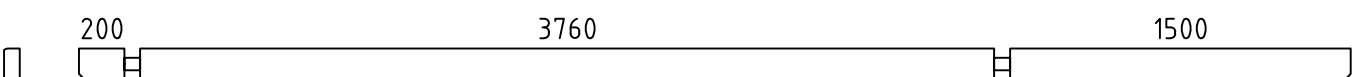
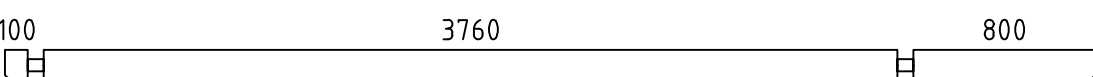
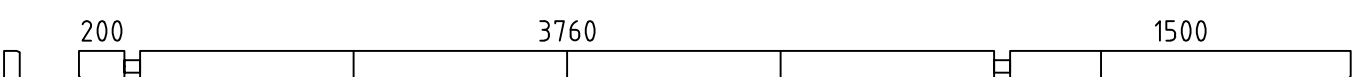
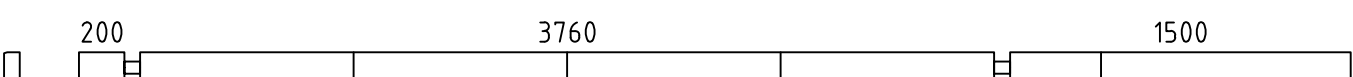
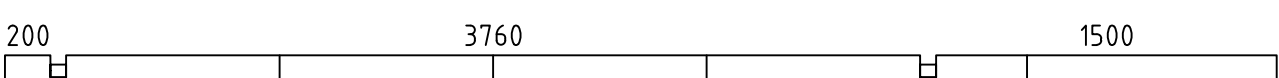
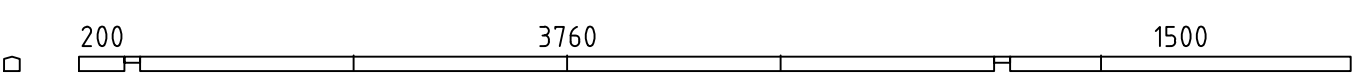
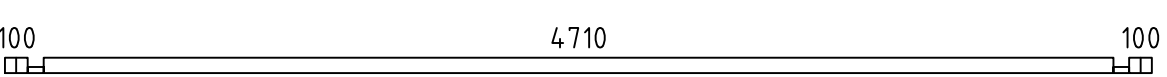
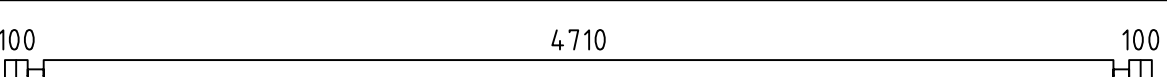
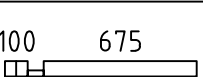
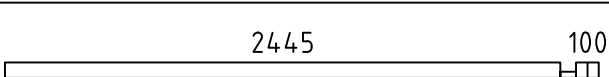
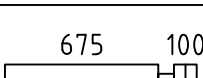
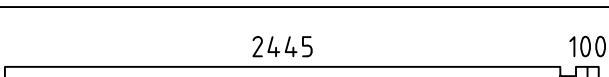
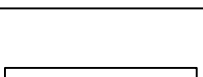
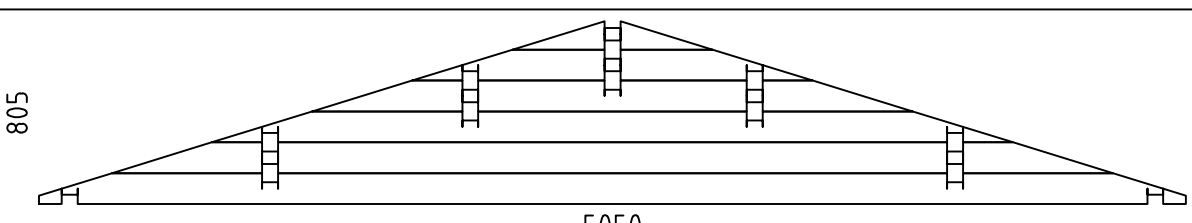
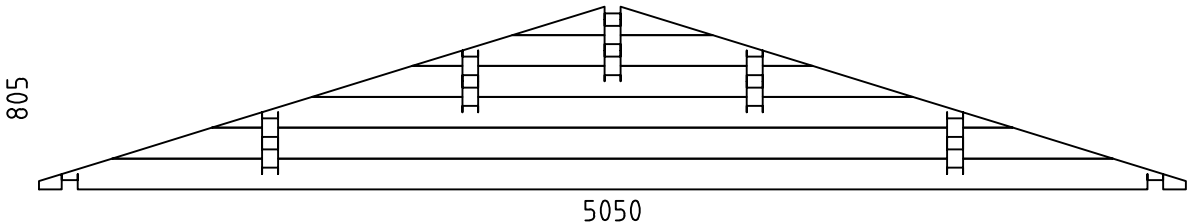



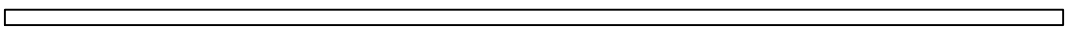
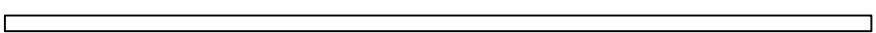

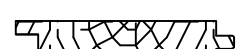

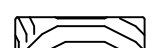

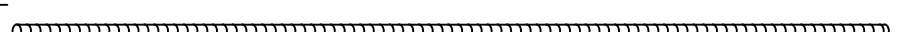
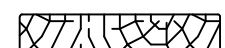

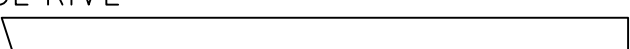



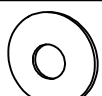

ART.NR. 700702



Pos	ART.NR. 700702 Piec list - Stückliste - Liste des pièces - Elementi	St.	Profile (mm)	Lenght (mm)
001		19	70x136	4100
002		1	70x136	4450
003		1	70x136	4800
004		2	70x136	5150
005		1	70x136	5600
006		12	70x136	1358
007		1	70x136	1708
008		1	70x136	2058
009		1	70x136	5600
010		5	70x136	4800
011		2	70x136	5600
012		2	70x136	5600
013		1	70x136	5600
014		1	70x63	5600
015		1	70x68	5050
016		16	70x136	5050
023		1	70x68	845
024		1	70x68	2615
025		21	70x136	845
026		7	70x136	2615
027		7	70x136	845
WA-1		1		
WB-1		1		



Pos	ART.NR. 700702 Piece list - Stückliste - Liste des pièces - Elementi	St.	Profile (mm)	Lenght (mm)
IAR1	FOUNDATION - FUNDAMENT - FONDAZIONE - FONDAMENTA 	11	45x70	4750
IAR2	FOUNDATION - FUNDAMENT - FONDAZIONE - FONDAMENTA 	2	45x70	3890
	FLOOR BOARDS - FUSSBODENBRETTER - LAME DE PLANCHER - PAVIMENTO 	53	90x18	3756
	ROOF BOARDS - DACHBRETTER - VOLIGES - PERLINA PER TETTO 	126	90x18	2800
	FLOOR FILLET - FUSSBODENLEISTE - CORNIERE DE FINITION DU PLANCHER - FINITURA PER PAVIMENTO (BATTISCO PA) 		18x18	16.92
	ROOFING FELT FILLET - DACHPAPPENLEISTE - BAGUETTE DE FIXATION DU FEUTRE BITUMEUX - FINITURA PER TETTO PER CARTA BITUMINOSA 	4	18x58	2850
	TREADED ROD M12 - GEWINDESTANGE M12 - TIGE FILETÉE M12 - BARRA FILETTATA PASSO M12 	4		186
	TREADED ROD M12 - GEWINDESTANGE M12 - TIGE FILETÉE M12 - BARRA FILETTATA PASSO M12 	4		2000
	FASCIA BOARD - TRAUFBRETT - BANDEAU DE TOIT - FINITURA LATI TETTO 	2	18x90	5600
	ROOF EDGE REINFORCEMENT - DACHRANDVERSTÄRKUNG - CORNIERE DE RENFORT DE BORD DE TOIT - RINFORZO x TETTO 	4	28x34	2800
	GABLE MOULDING - GIEBELLEISTE - PLANCHE DE RIVE - FINITURA PER FRONTALE E RETRO DEL TETTO 	4	18x120	2850
	GABLE SEGMENT - DECKBLATT - LOSANGE DE FINITION - DECORAZIONE IN LEGNO x FRONTALE TETTO 	2		
	LENGTHENING BOLT FOR TREADED ROD - VERLÄNGERUNGSMUTTER FÜR GEWINDESTANGE - MANCHON DE RACCORDEMENT DE TIGE FILETÉE - BULLONE PER BARRA FILETTATA PASSO 	4		
	DRIVE NUT TREADED ROD - EINSHLAGMUTTER FÜR GEWINDESTANGE - ÉCROU A FRAPPER POUR TIGE FILETÉE - DADO GUIDA PER BARRA FILETTATA 	4		
	NUT FOR TREADED ROD - MUTTER FÜR GEWINDESTANGE - ÉCROU POUR TIGE FILETÉE - DADO PER BARRA FILETTATA 	4		
	PLAIN WASHER TREADED ROD - UNTERLEGSCHLEIBE FÜR GEWINDESTANGE - RONDELLE PLATE POUR TIGE FILETÉE - RONDELLA PER BARRA FILETTATA 	4		
	SCREW FOR GABLE SEGMENT - SCHRAUBEN FÜR DECKBLATT - VIS POUR FIXATION LOSANGE DE FINITION - VITI x FRONTALI TETTO 	4	3.5x35	
	SCREW FOR ROOF BOARDS - SCHRAUBEN FÜR DACHBRETTER - VIS D'ASSEMBLAGE DES VOLIGES DE TOIT - VITI PER LE PERLINE DEL TETTO 	524	3.5x50	
	SCREW FOR FLOOR BOARDS - SCHRAUBEN FÜR FUSSBODENBRETTER - VIS D'ASSEMBLAGE DES LAMES DE PLANCHER - VITI PER LE PERLINE DEL PAVIMENTO 	486	3.5x50	
	SCREW FOR GABLE MOULDING - SCHRAUBEN FÜR GIEBELLEISTE - VIS POUR FIXATION PLANCHE DE RIVE - VITE PER FISSARE FINITURE DAVANTI E DIETRO DEL TETTO 	32	3.5x50	
	SCREW FOR FASCIA BOARDS - SCHRAUBEN FÜR TRAUFBRETT - VIS POUR FIXATION BANDEAU DE TOIT - VITI x STRISCIA DEL TETTO 	26	4x40	
	SCREW FOR ROOF EDGE REINFORCEMENT - SCHRAUBEN FÜR DACHRANDVERSTÄRKUNG - VIS POUR FIXATION CORNIERE RENFORT DE BORD DE TOIT - VITI x RINFORZO BORDO TETTO 	26	4x40	
	SCREW FOR ROOF BEAMS - SCHRAUBEN FÜR DACHBALKEN - VIS POUR FIXATION PANNES DE TOIT - VITI PER PERLINE DEL TETTO 	14	5x120	
	SCREW FOR GABLE - SCHRAUBEN FÜR GIEBEL - VIS POUR FIXATION DES PIGNONS - VITI PER TIMPANO 	24	5x120	
	SCREW FOR 1. WALL BEAM - SCHRAUBE FÜR 1. BOHLENREIHE - VIS DE FIXATIONS 1ere RANGÉE DE MADRIERS AVEC POUTRELLES DE FONDATIONS - VITE FISSAGGIO ALLE FONDAMENTA 	8	5x120	



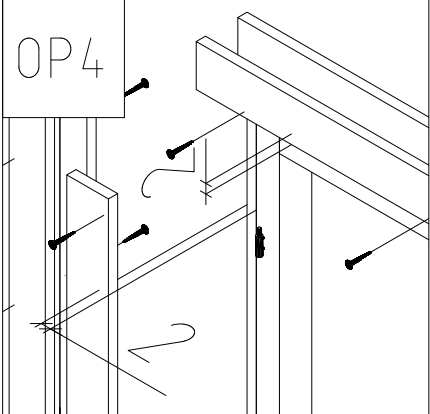
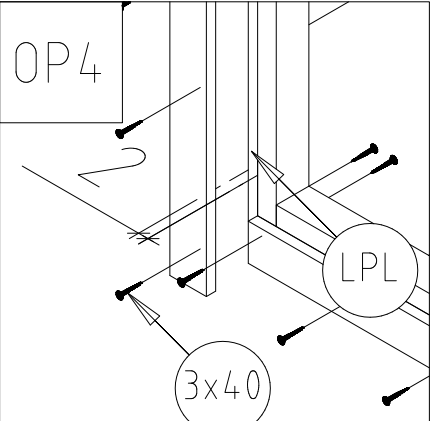
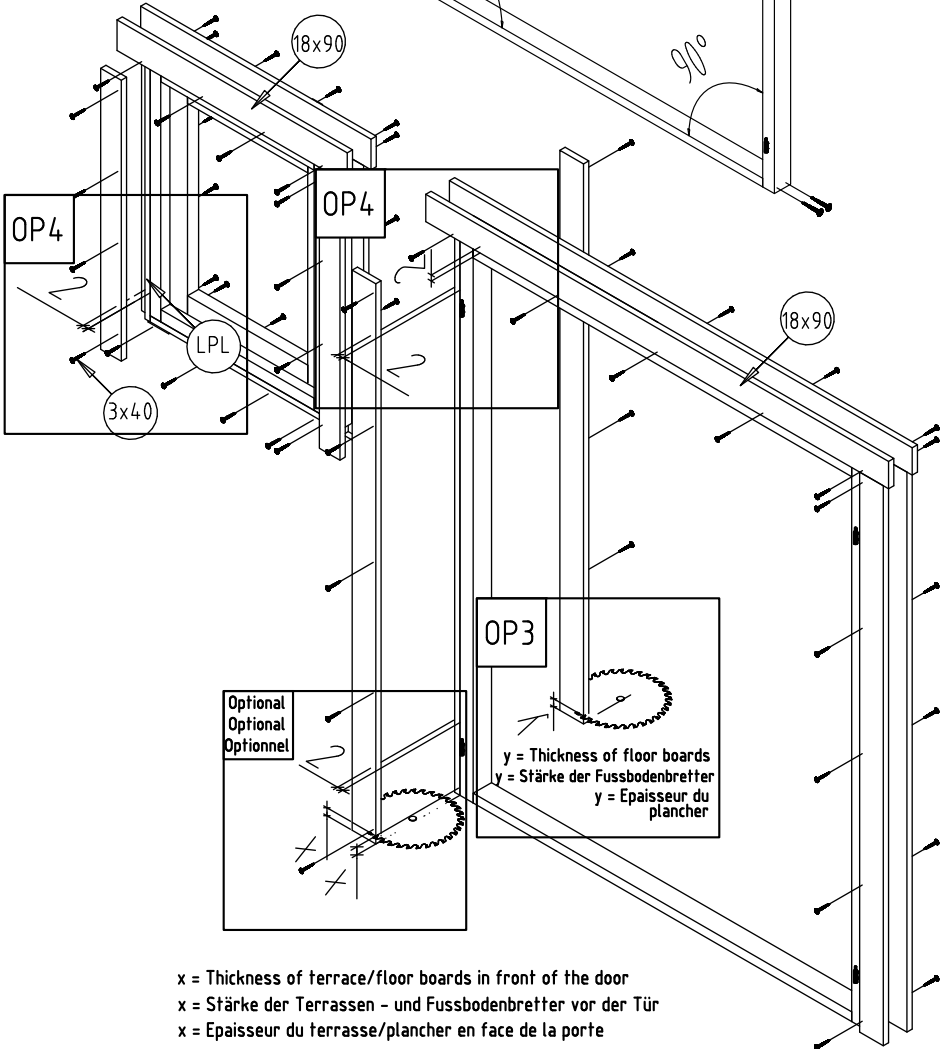
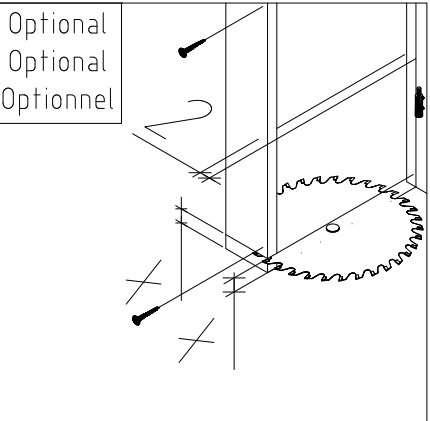
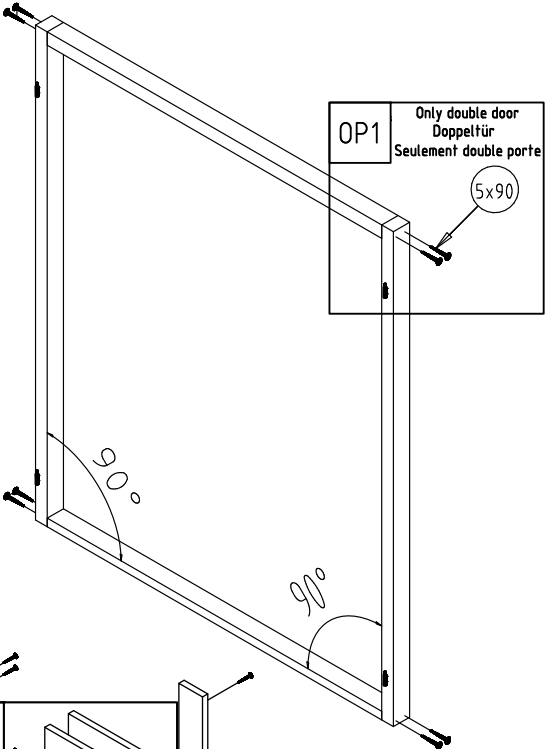
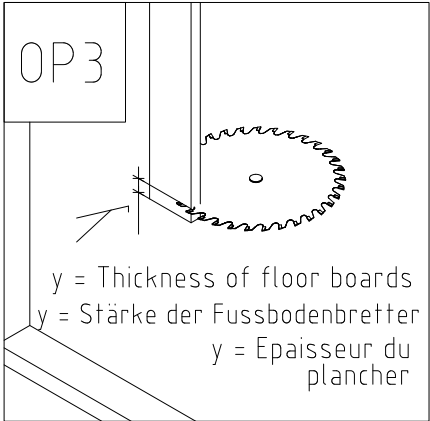
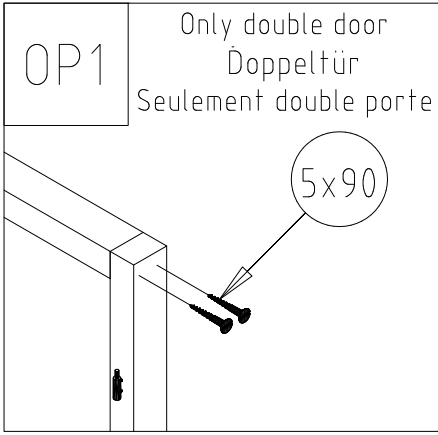

x = Thickness of terrace/floor boards in front of the door  
x = Stärke der Terrassen - und Fussbodenbretter vor der Tür  
x = Epaisseur du terrasse/plancher en face de la porte

