

*Tampa 2.0*  
*Art. Nr. 2825099*  
1/6

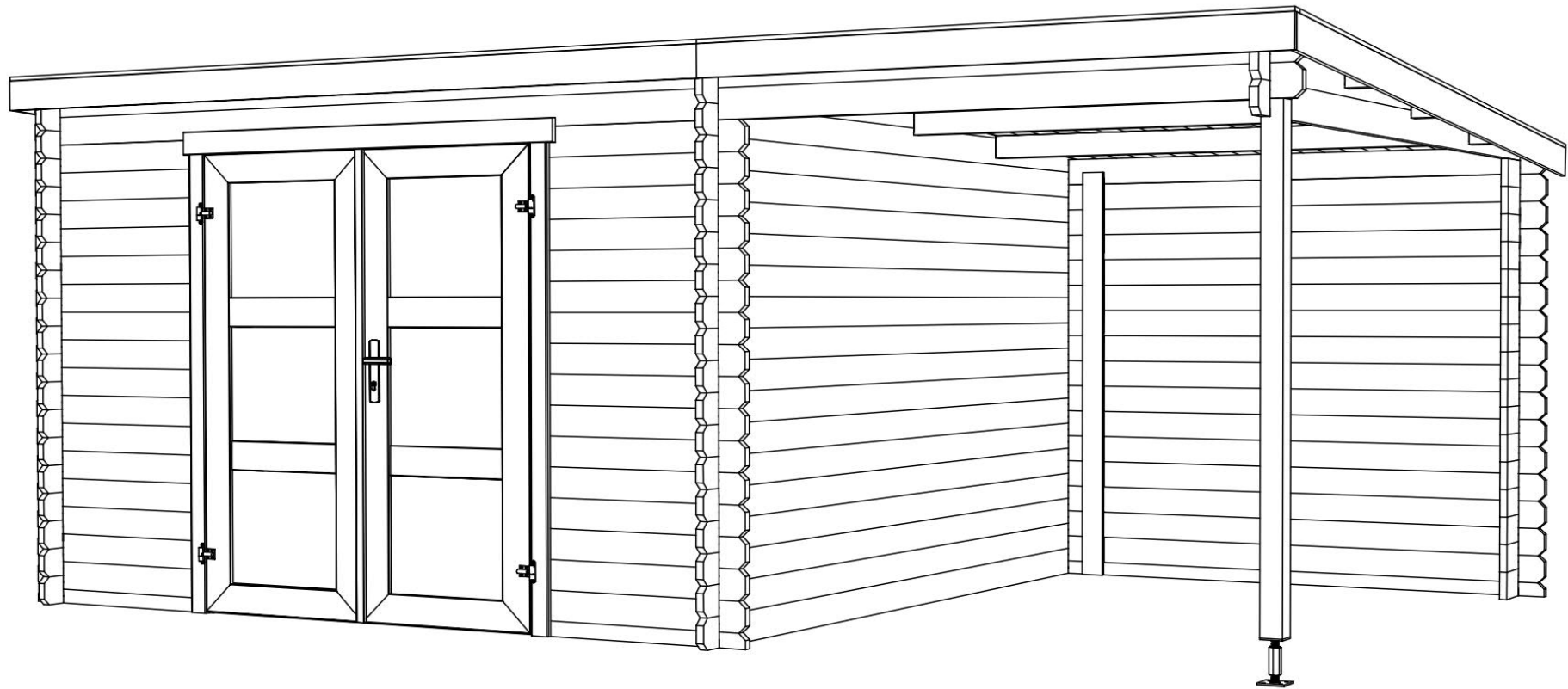

Art. Nr. 2825099

Groundplan - Grundplan - Plan de masse -  
Planimetria - Plattegrond - Põhiplaan

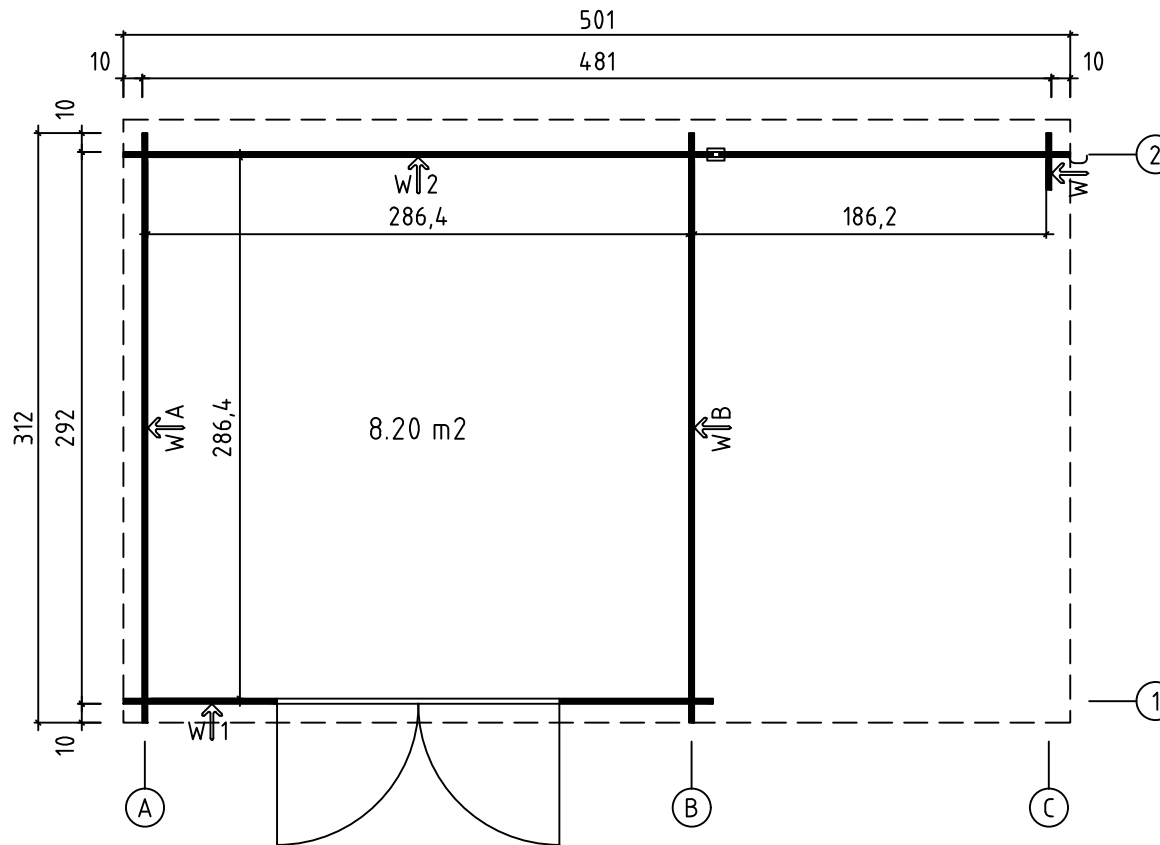



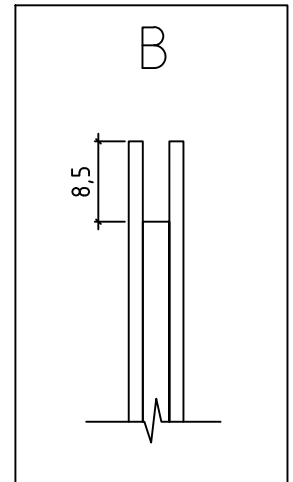
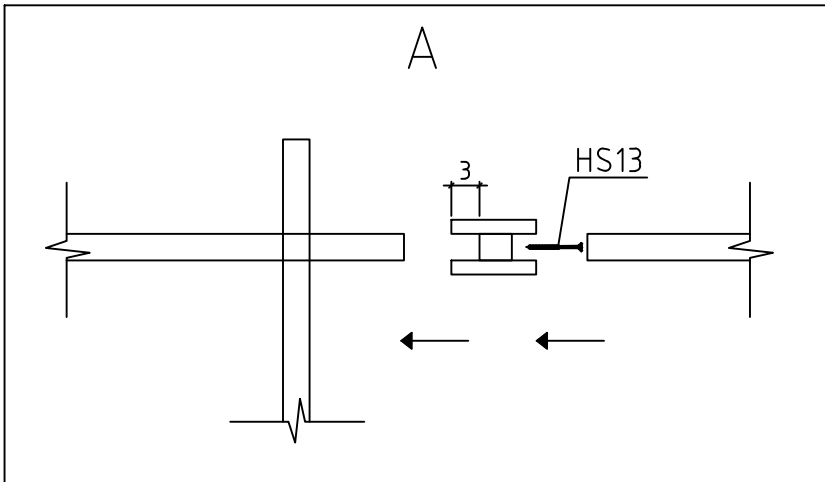
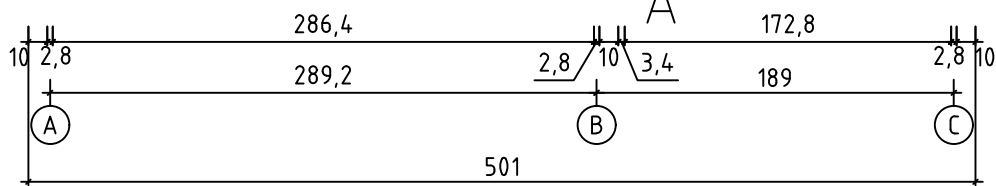
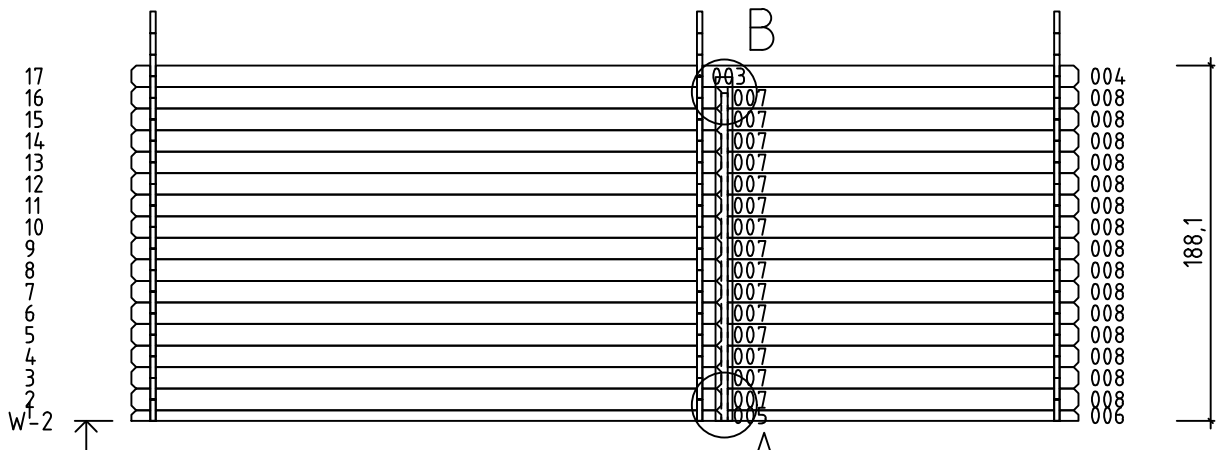
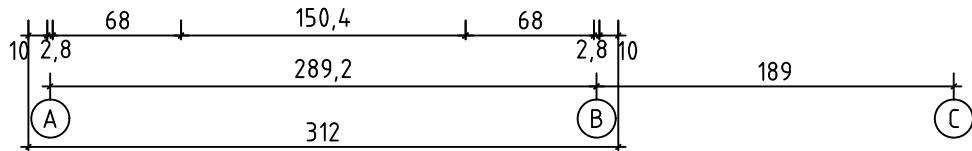
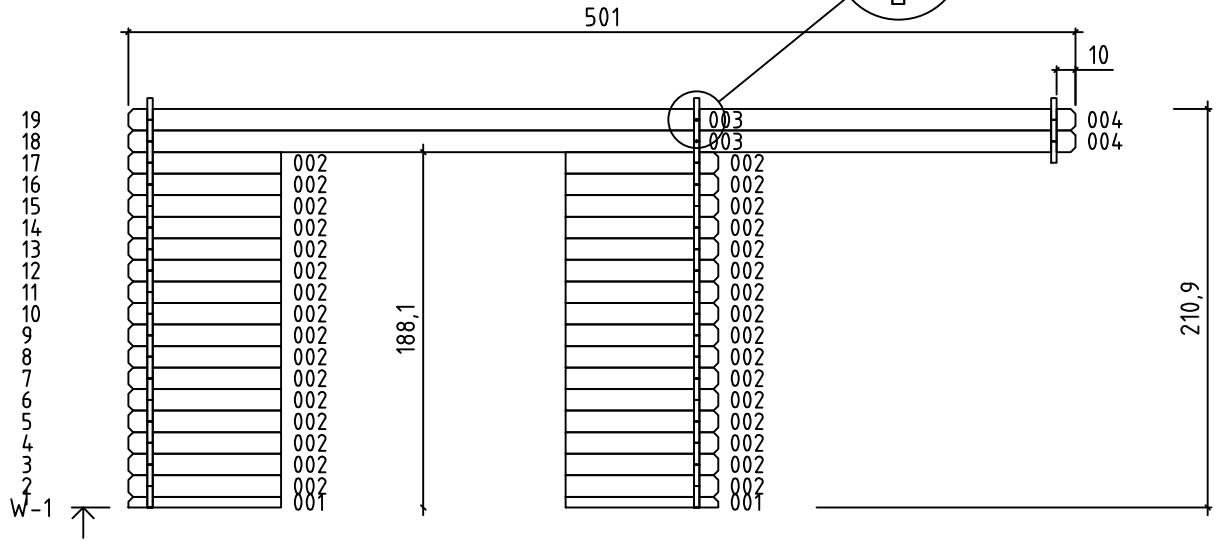
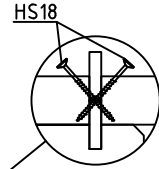

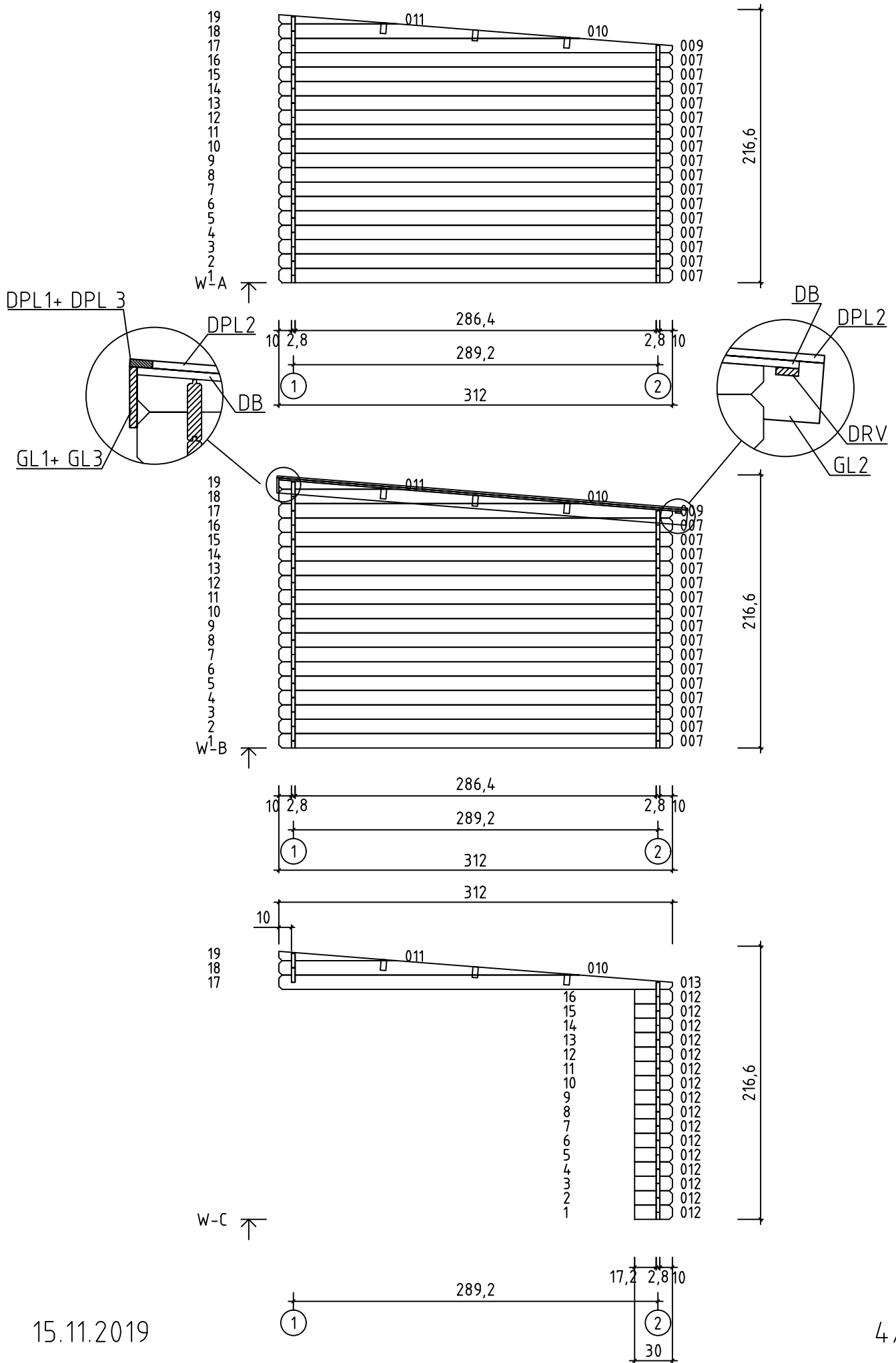

Art. Nr. 2825099



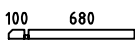
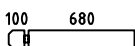
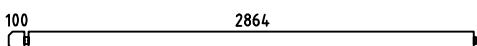
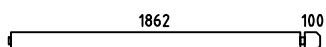
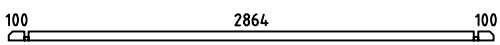
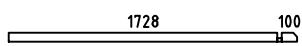
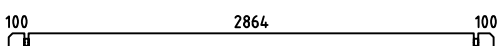
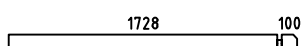

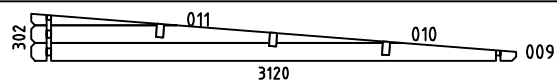
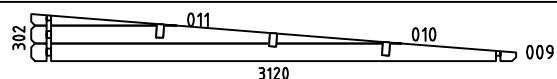
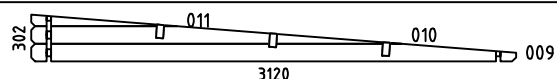
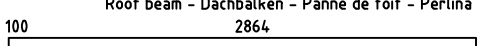
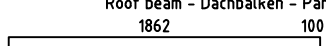



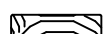
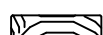
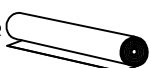
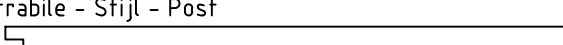
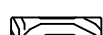
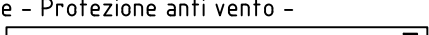



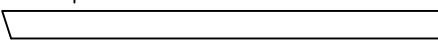
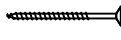









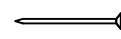
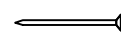

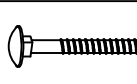
Art. Nr. 2825099

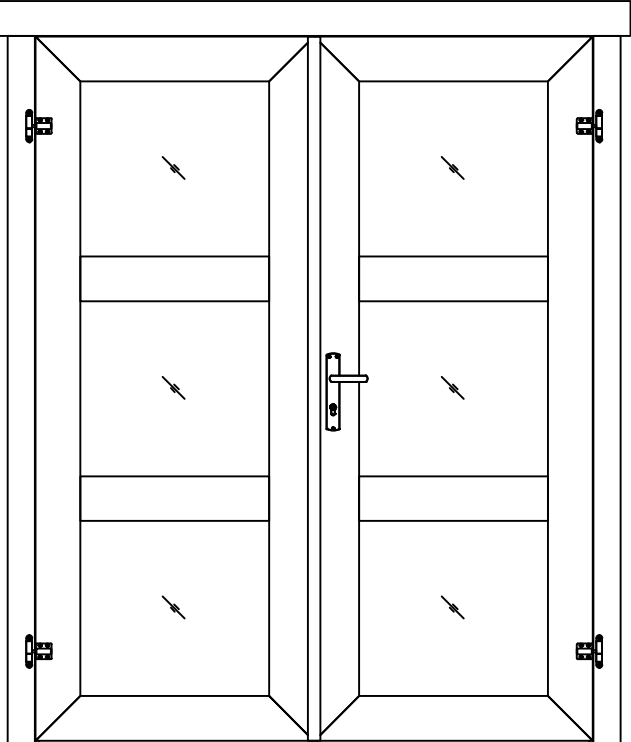
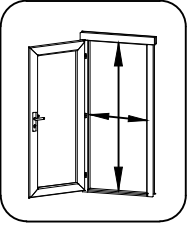

15.11.2019

Pos	15.11.2019 Piece list - Stückliste - Liste des pièces - Elementi - Stuklijst - Tükitalabel Art. Nr. 2825099	5/6	Q	P (mm)	L (mm)
001			2	28x57	808
002			32	28x114	808
003			3	28x114	3006
004			3	28x114	2004
005			1	28x57	3120
006			1	28x57	1856
007			47	28x114	3120
008			15	28x114	1856
012			16	28x114	300
WA-1			1		
WB-1			1		
WC-1			1		
A-PR1	Roof beam - Dachbalken - Panne de toit - Perlina del tetto - Gordingen / dakbalk - Pärilin 		3	44x95	3006
A-PR2	Roof beam - Dachbalken - Panne de toit - Perlina del tetto - Gordingen / dakbalk - Pärilin 		3	44x95	2004
DB	Roof boards - Dachbretter - Voliges - Perlina per tetto - Dakhout - Katuselaud 		56	90x15	3200
HP	H-profile - H-profils - Profile H - Profilo ad H - H-profiel - H-profiil 		1	58x90	1820
DPL3	Roofing felt fillet - Dachpappenleiste - Baguette de fixation du feutre bitumeux - Asse per fissaggio guaina bituminosa - Afdekljst asfaltpapier - Katusepapiilist 		1	15x45	2019
DPL1	Roofing felt fillet - Dachpappenleiste - Baguette de fixation du feutre bitumeux - Asse per fissaggio guaina bituminosa - Afdekljst asfaltpapier - Katusepapiilist 		1	15x45	3021
DPL2	Roofing felt fillet - Dachpappenleiste - Baguette de fixation du feutre bitumeux - Asse per fissaggio guaina bituminosa - Afdekljst asfaltpapier - Katusepapiilist 		2	15x45	3220
DPP-1	Roofing felt (strip) - Dachpappe (bahnen) - Feutre bitumeux (bande) - Cartone catramato - Asfaltpapier (baan) - Katusepapp 		4		5110
p	Post - Pfosten - Poteau - Piede registrabile - Stijl - Post 		1	70x70	1730
DRV	Roof edge reinforcement - Dachrandverstärkung - Corniere de renfort de bord de toit - Rinforzo x tetto - Dakrand versterking - Räästatugevdus 		2	15x45	2505
KFS-1	Storm protection - Sturmleiste - Latte anti-tempete - Protezione anti vento - Stormverankering / beveiliging - Tormikinnitusliist 		5	22x45	2050

Pos	15.11.2019 Piece list - Stückliste - Liste des pièces - Elementi - Stuklijst - Tükítabel Art. Nr. 2825099 6/6	Q	P (mm)	L (mm)
GL3	Gable moulding - Giebelleiste - Planche de rive - Finitura per frontale e retro del tetto - Gevellijst - Viilulaud 	1	15x120	2019
GL1	Gable moulding - Giebelleiste - Planche de rive - Finitura per frontale e retro del tetto - Gevellijst - Viilulaud 	1	15x120	3021
GL2	Gable moulding - Giebelleiste - Planche de rive - Finitura per frontale e retro del tetto - Gevellijst - Viilulaud 	2	15x120	3250
HS9	Screw for gable moulding - Schrauben für giebelleiste - Vis pour fixation planche de rive - Vite per fissare finiture davanti e dietro del tetto - Schroef voor gevellijst - Kruvi viilulauale 	32	3.5x50	
HS4	Screw for roof edge reinforcement - Schrauben für dachrandverstärkung - Vis pour fixation corniere renfort de bord de toit - Viti x rinforzo bordo tetto - Schroef voor dakrand versterking - Kruvi räästatugevdusele 	12	3x30	
HS13	Screw for post - Schrauben für pfosten - Vis de fixation des poteaux - Viti per inviare - Schroef voor stijlen - Kruvi postile 	2	4x60	
HS13	Screw for wall mounting - Schrauben für wandmontage - Vis de fixation au mur - Viti per montaggio a parete - Schroef voor wandmontage - Kruvi seinte montaažiks 	1	4x60	
HS18	Screw for roof beams - Schrauben für dachbalken - Vis pour fixation pannes de toit - Viti per perline del tetto - Schroef voor gordingen / dakbalken - Kruvi pärlinitele 	12	5x120	
HS18	Screw for wall details - Schraube für wand details - Vis pour mur details - Viti per elementi della porta - Schroef voor wand details - Kruvi seinadetailile 	6	5x120	
HS18	Screw for gable - Schrauben für giebel - Vis pour fixation des pignons - Viti per timpano - Schroef voor gevelpunt - Kruvi viilude kinnitamiseks 	6	5x120	
HS20	Screw for post height adjustment - Schrauben für regulierungsschraube für pfosten - Vis de fixation de support réglable de poteau - Viti per fissare ed aggiustare l'altezza del palo verticale - Schroef voor hoogte instelling stijlen - Kruvi vajumispoldile 	8	6x50	
SH28	Hammer block - Schlagholz - Calle de frappe - Blocco di legno da usare come cuscinetto quando si usa il martello - Slagklos - Löögiklots 	1		
SFS	Nut for storm protection - Schraubenmutter für sturmleiste - Ecrou pour latte anti-tempete - Dado x asta protezione vento - Moer voor stromverankering - Mutter tormikinnusliistule 	10	D6	
NF4	Zn nail for roof - Zn nagel für dachbretter - Pointe pour fixation voliges de toit - Chiodi x perline tetto - Spijker(nagel) voor dakhout - Nael katuselauale 	293	2x50	
NF5	Zn nail for roofing felt fillet - Zn nagel für dachpappenleiste - Pointe pour baguette de fixation feutre bitumeux - Chiodi x carta bituminosa x tetto - Spijker(nagel) voor asfaltpapier afdekljst - Papilistunael 	26	2x40	
NF6	Roofing nails for roofing felt - Nägel für dachpappe - Pointe pour fixation feutre bitumeux - Chiodi per cartone catramato - Asfaltnagel - Papinael 	175	2.8x15	
BFS	Bolt for storm protection - Bolzen für sturmleiste - Boulon pour latte anti-tempete - Bullone x asta protezione vento - Bout voor stormankerlat - Puidupolt tormikinnusliistule 	10	6x60	
DFS	Washer for storm protection - Dichtscheibe für sturmleiste - Rondelle pour latte anti-tempete - Rondella x asta protezione vento - Afdichtring voor storm strip - Seib tormikinnusliistule 	10	D6	
	Post height adjustment - Regulierungsschraube für pfosten - Support réglable de poteau - Piede registrabile in altezza - Stelschroef voor stijlpost - Vajumispolt 	1	D20	
	Door - Tür - Porte - Porte - Deur - Uks 14.94x1850 TUK.3.030.MXVP.MX28 MXGA+28	1		

Pos	Piece list - Stückliste - Liste des pièces - Elementi - Stuklijst - Tükítabel 14.94x1850 TUK.3.030.MXVP.MX28 MXGA+28	1/2	Q	P (mm)	L (mm)
	<p>Glass size - Glasgröße - Taille de la vitre - Misura del vetro - Glas afmeting - Klaasi mõõt: 502x467 mm</p>   <p>1418x1792 mm</p>				
1	Upper door jamb - Türrahmen oben - Cadre de porte supérieur - Telaio superiore della porta - Bovendorpel - Ukse ülemine leng		1	66x100	1438
2	Left door jamb - Türrahmen links - Cadre de porte gauche - Telaio montante sinistro della porta - Linkerstijl deurframe - Ukse vasak leng		1	66x80	1850
3	Right door jamb - Türrahmen rechts - Cadre de porte droit - Telaio montante destro della porta - Rechterstijl deurframe - Ukse parem leng		1	66x80	1850
4	Doorstep - Swelle - Barre de seuil - Soglia della porta - Deurdorpel - Lävepak		1	18x18	1418
5	Connection strip - Deckleiste - Baguette de battement - Profilo verticale della porta - Stulplijst - kokkuvaltšiliist		1	13x32	1812





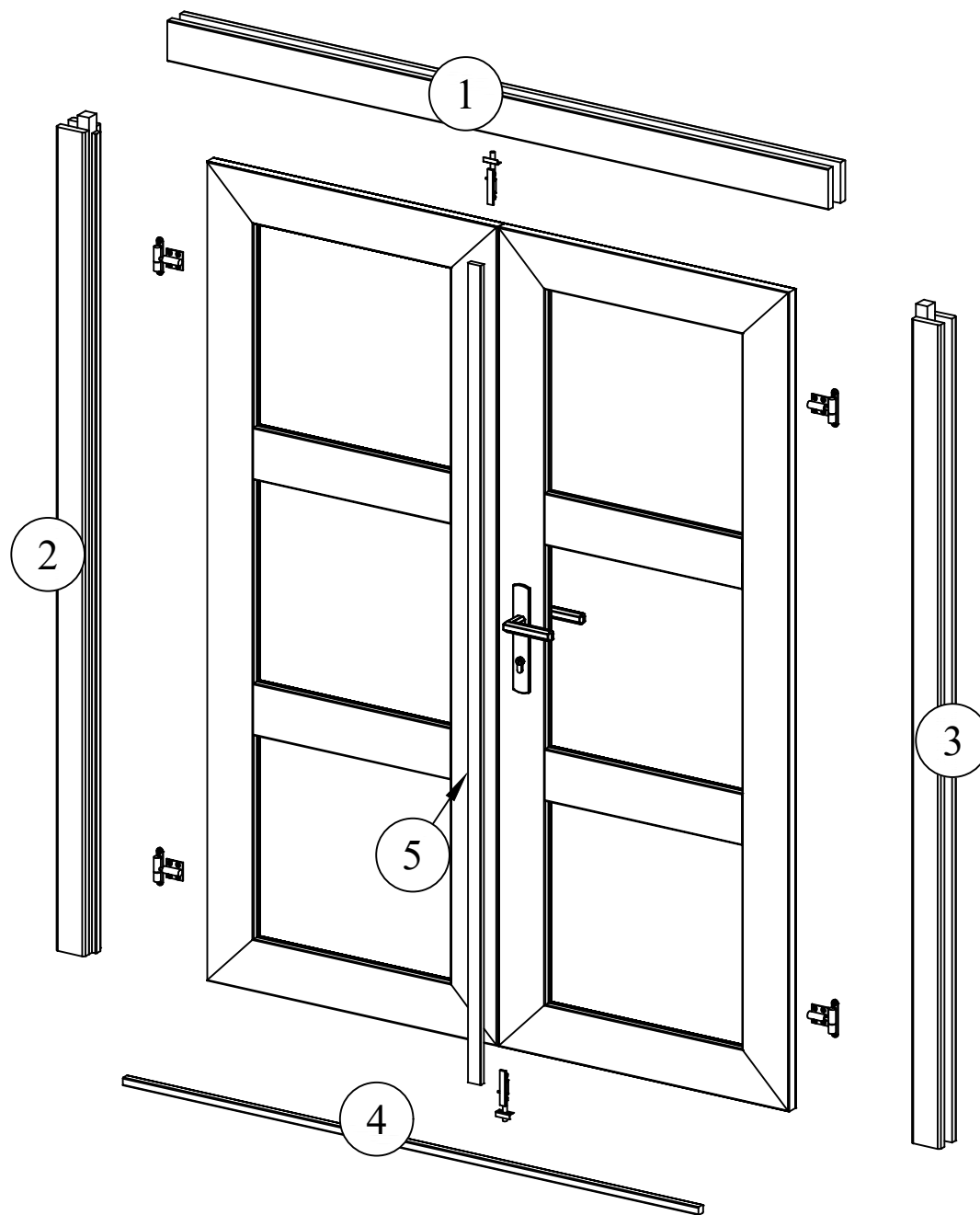

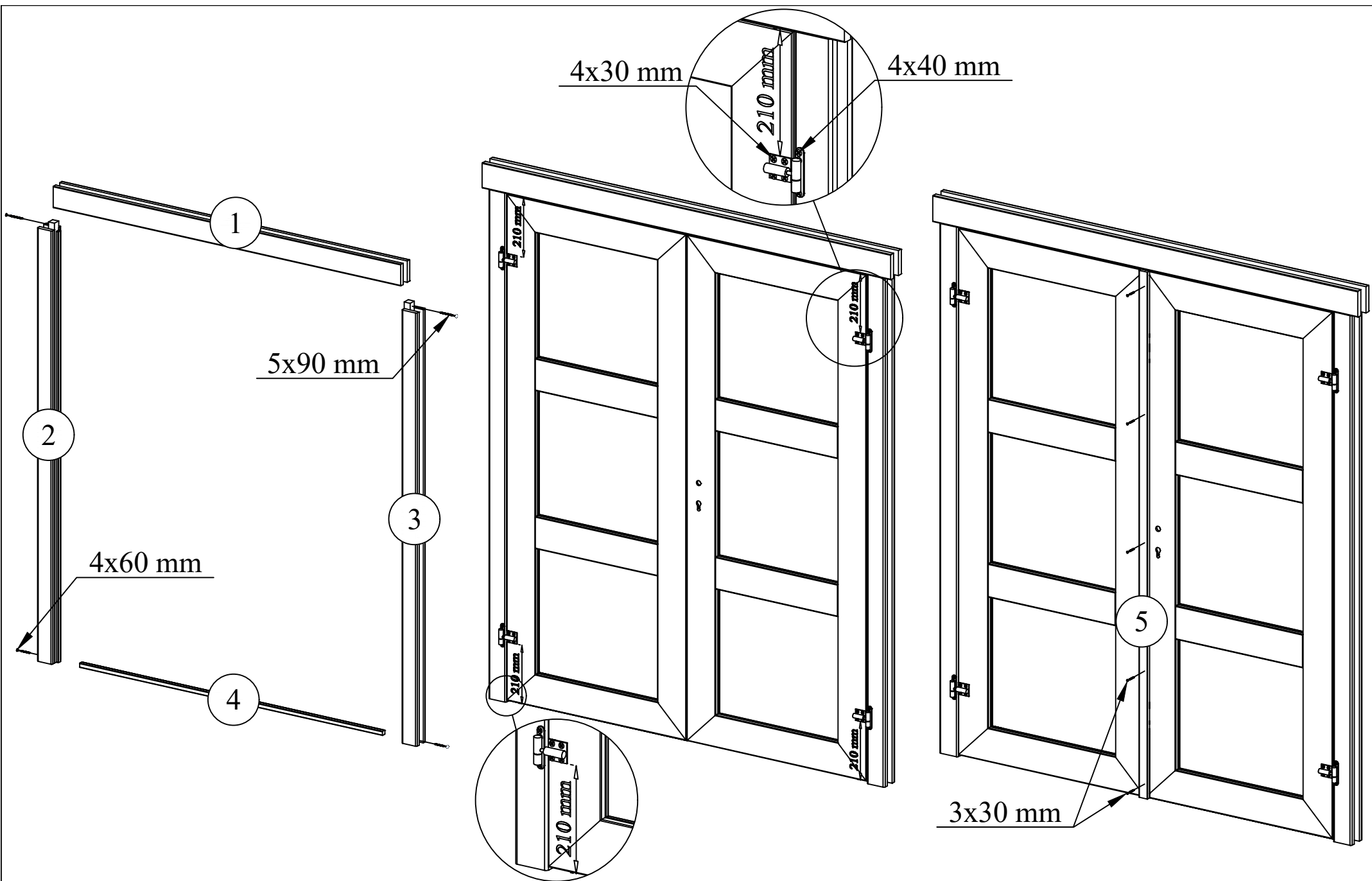

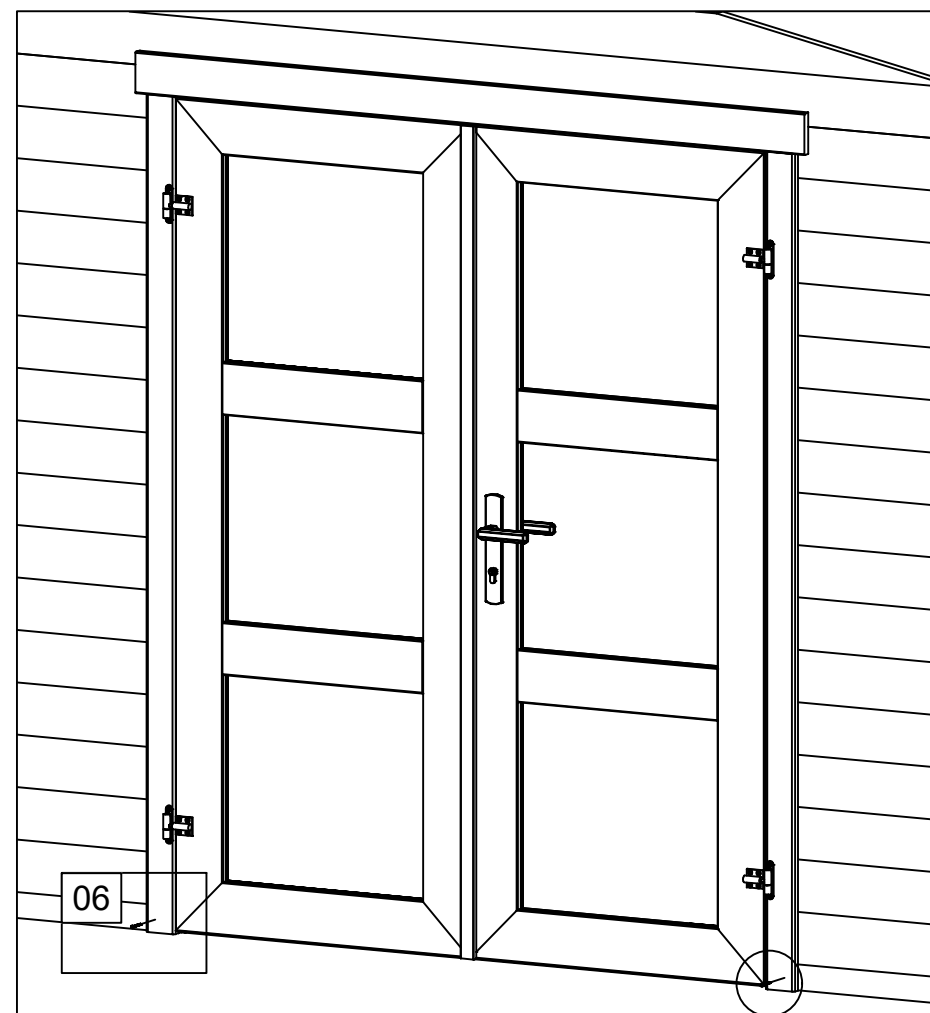
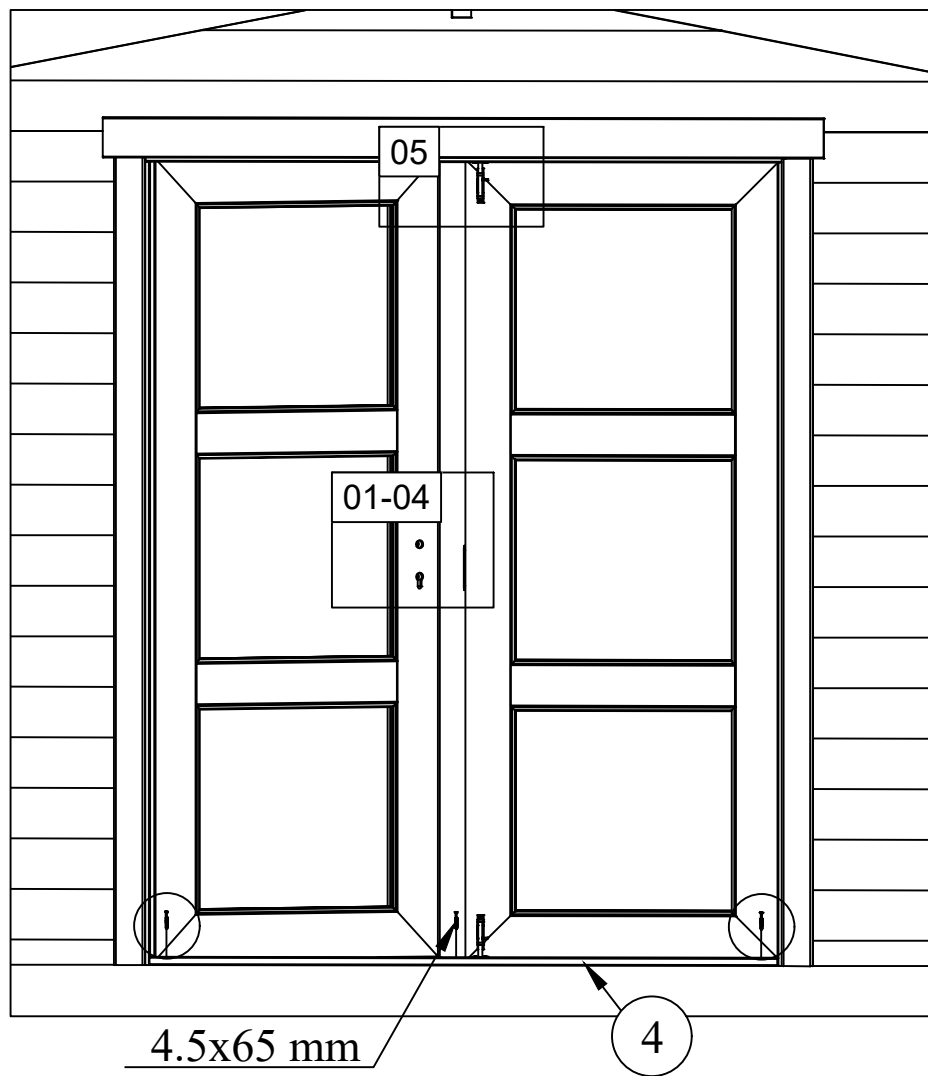

01

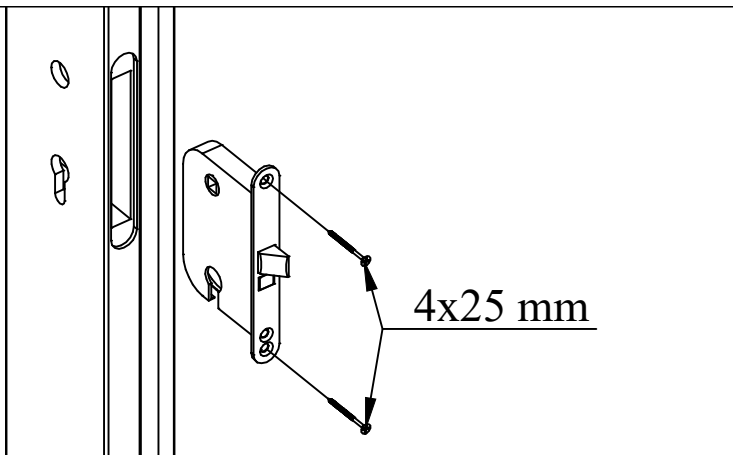

04

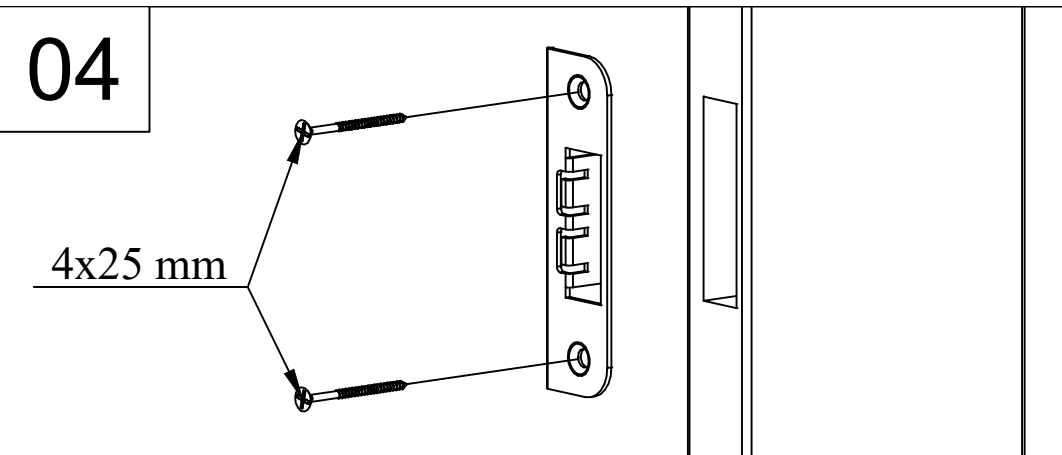

02

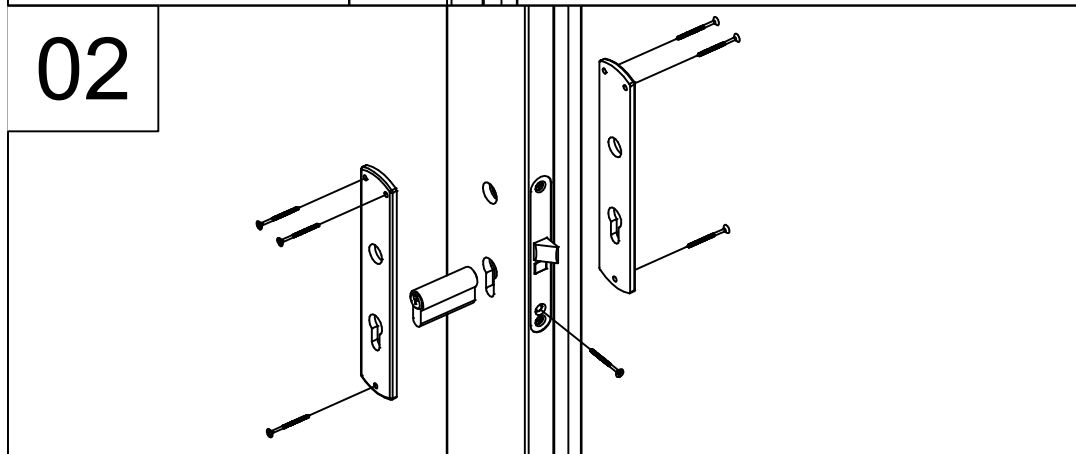

05



03

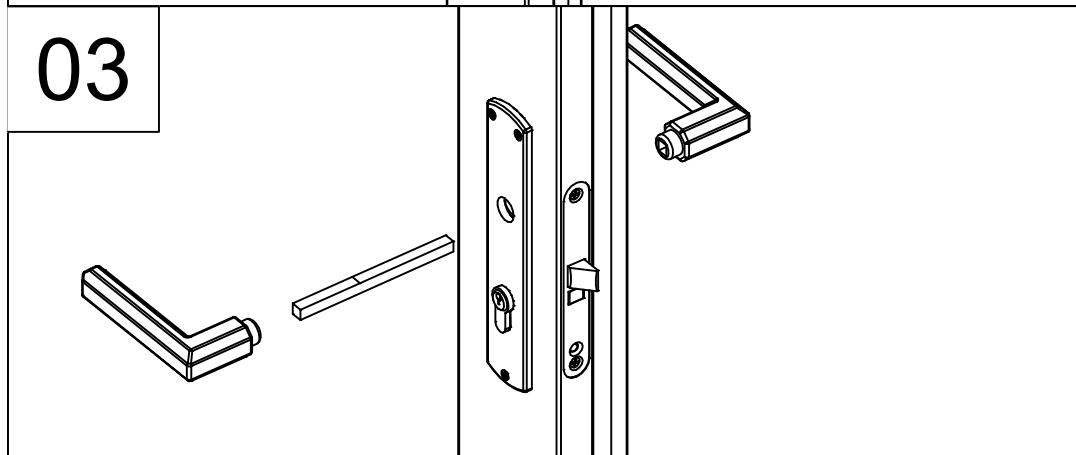

06

