

*St Louis 2.0*  
*Art. Nr. 2824699*  
1/6

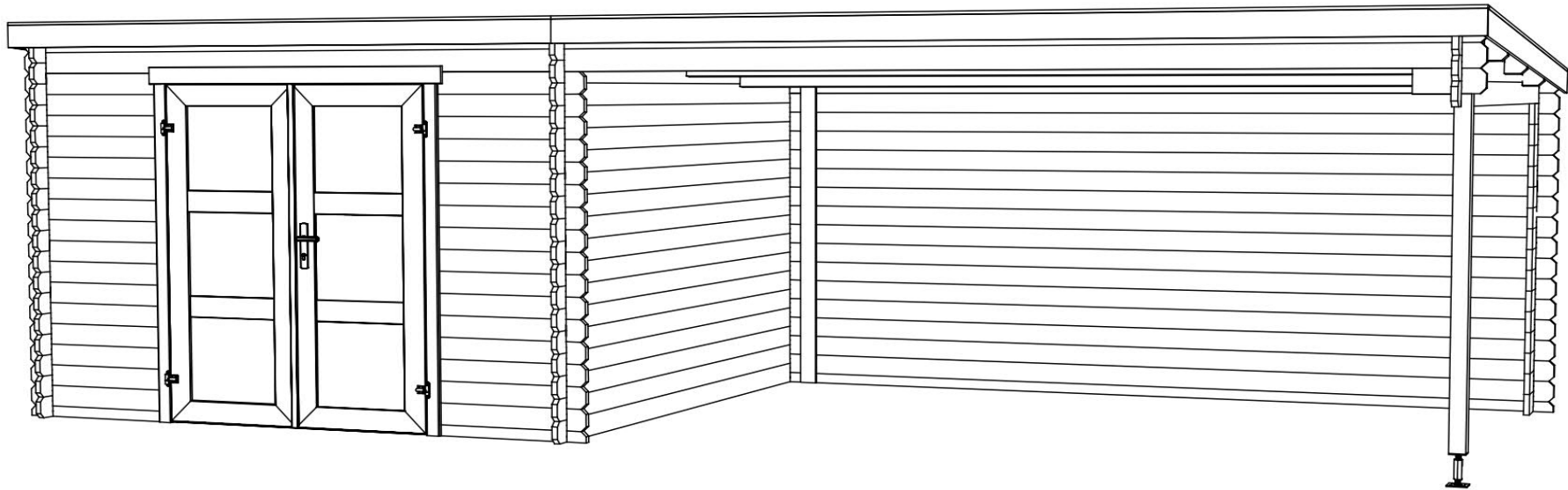

Art. Nr. 2824699

Groundplan - Grundplan - Plan de masse - Planimetria -  
Plattegrond - Põhiplaan

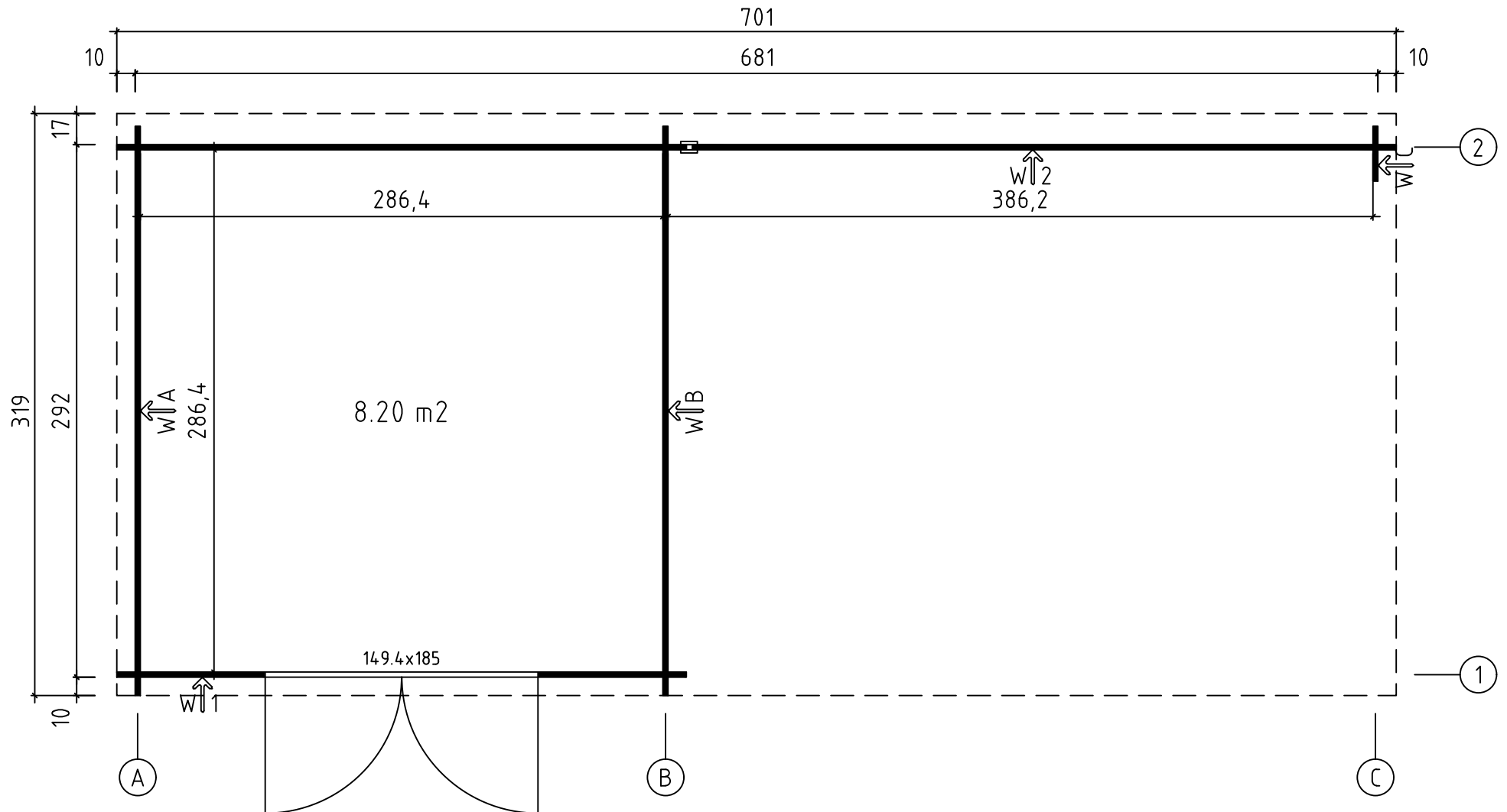







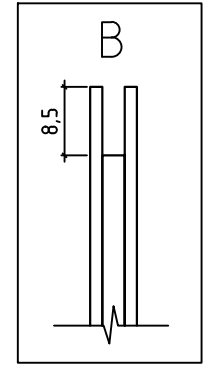
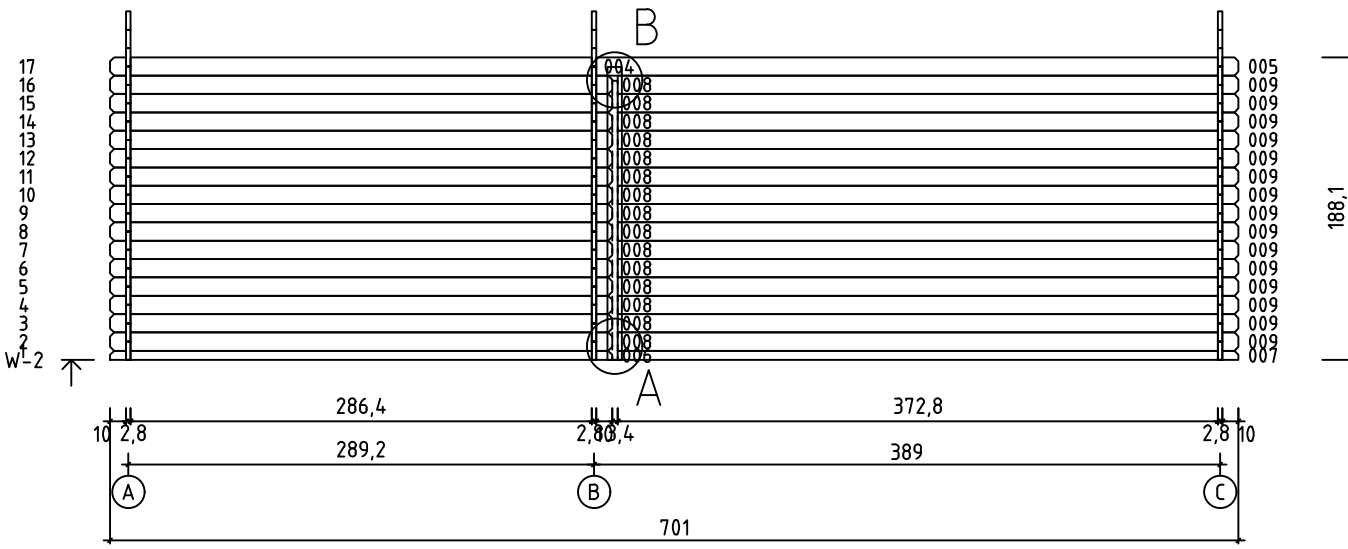
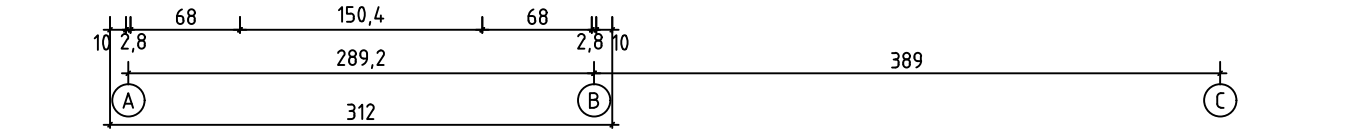
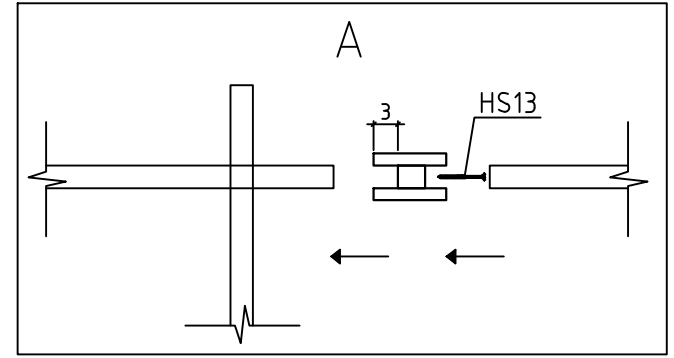
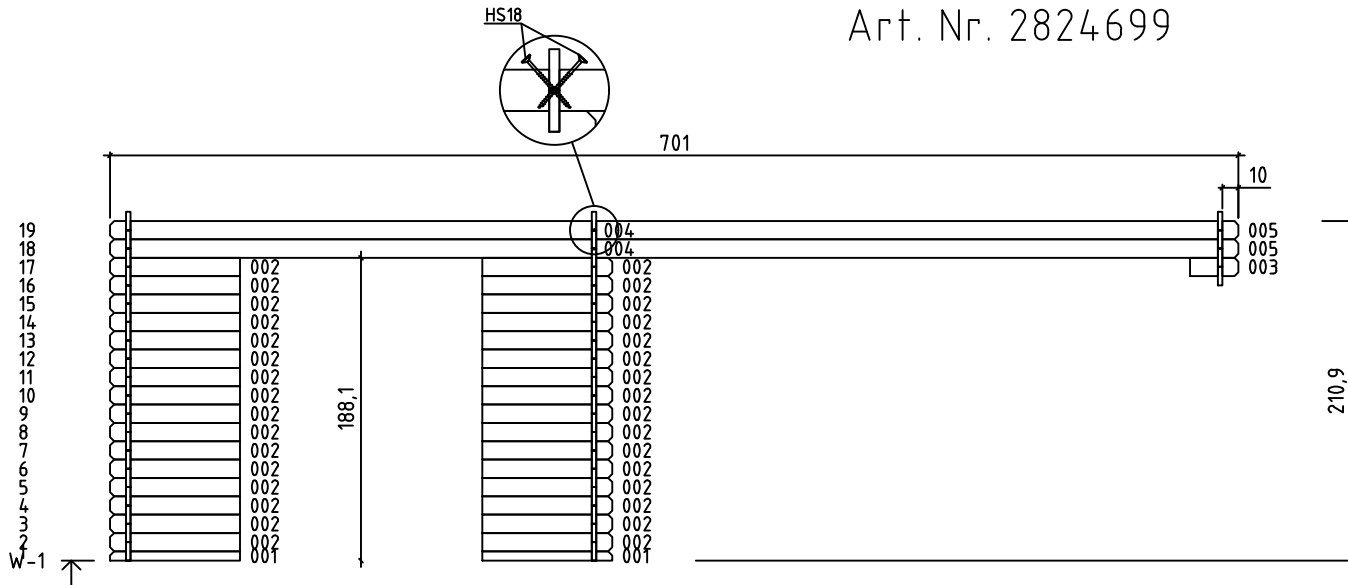

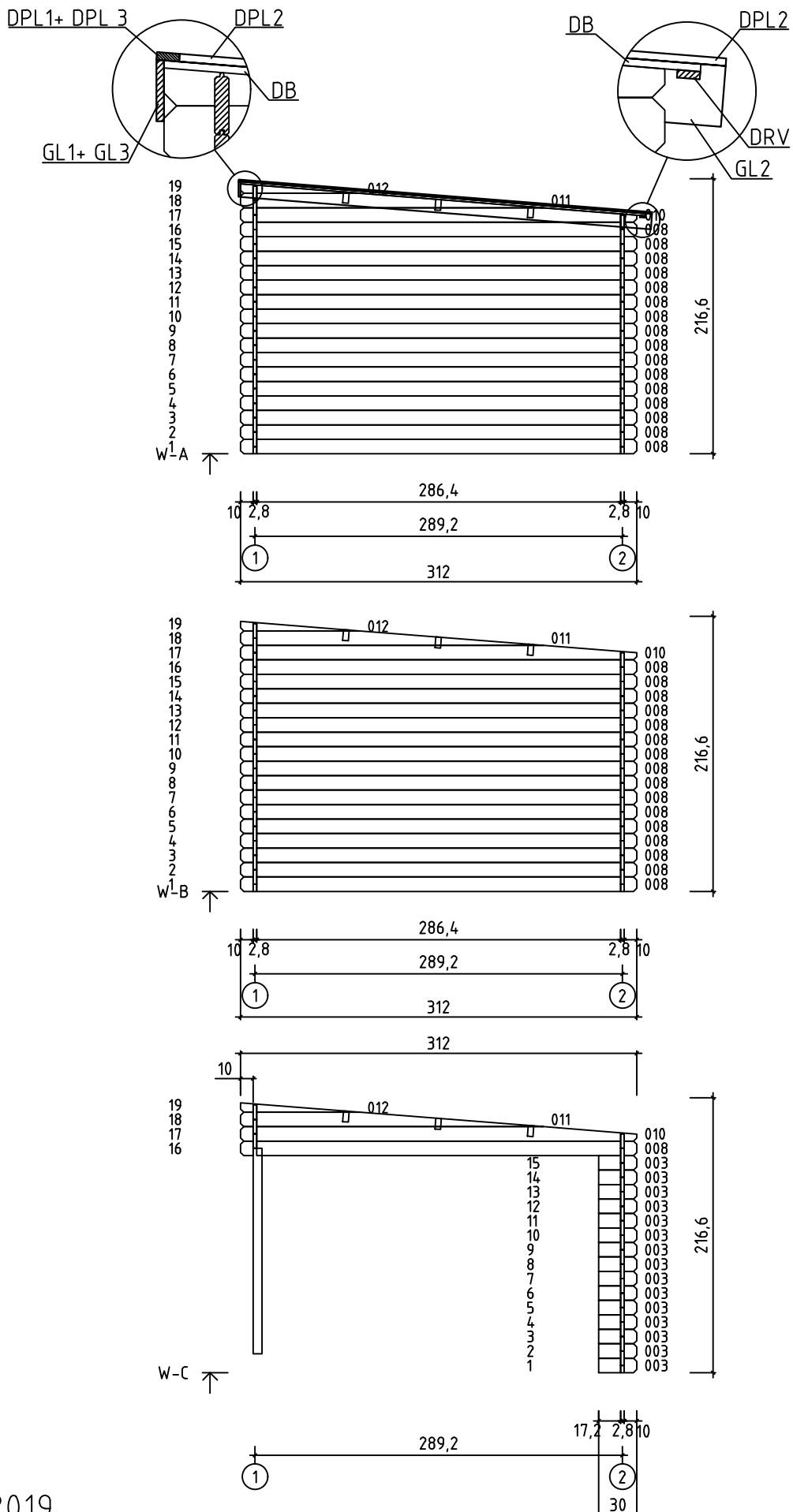

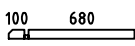
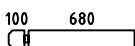
15.11.2019

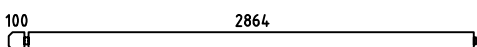
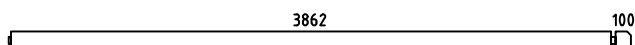
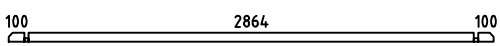
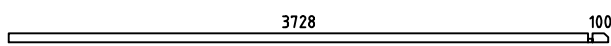
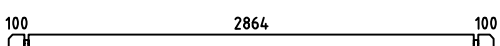
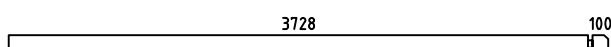
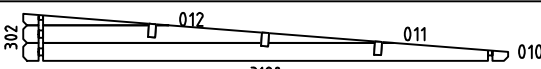
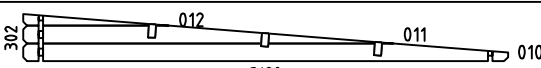
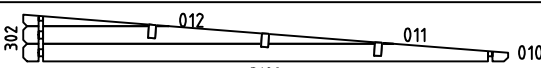
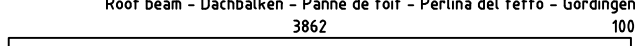
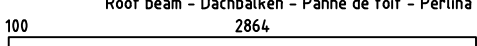
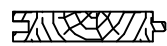



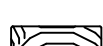

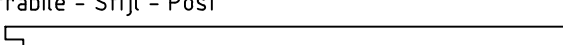

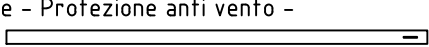

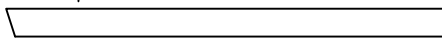

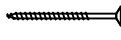



2/6





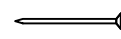
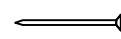

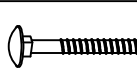
Art. Nr. 2824699



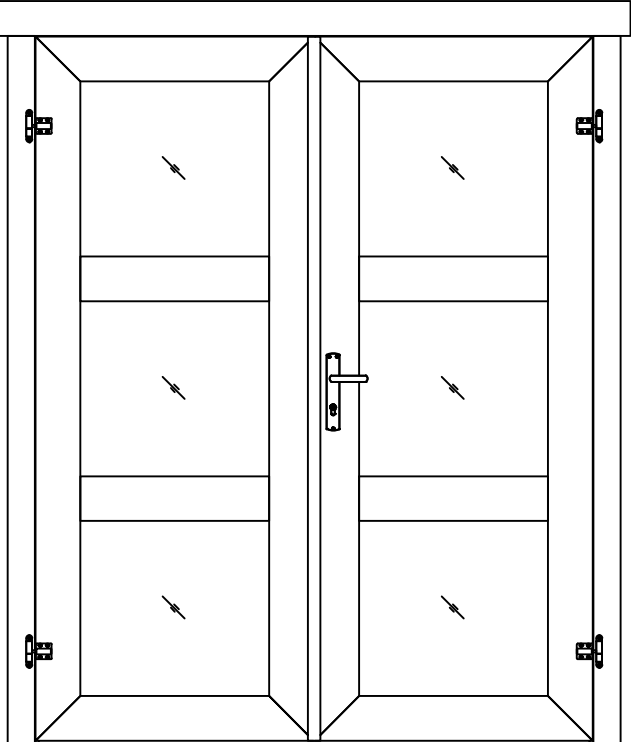
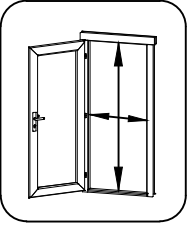

| Pos   | 15.11.2019 Piece list - Stückliste - Liste des pièces - Elementi - Stuklijst - Tükítabel<br>Art. Nr. 2824699 5/6  | Q  | P<br>(mm) | L<br>(mm) |
|-------|---|----|-----------|-----------|
| 001   |    | 2  | 28x57     | 808       |
| 002   |    | 32 | 28x114    | 808       |
| 003   |    | 16 | 28x114    | 300       |
| 004   |    | 3  | 28x114    | 3006      |
| 005   |    | 3  | 28x114    | 4004      |
| 006   |    | 1  | 28x57     | 3120      |
| 007   |    | 1  | 28x57     | 3856      |
| 008   |    | 48 | 28x114    | 3120      |
| 009   |    | 15 | 28x114    | 3856      |
| WA-1  |    | 1  |           |           |
| WB-1  |   | 1  |           |           |
| WC-1  |   | 1  |           |           |
| A-PR2 | Roof beam - Dachbalken - Panne de toit - Perlina del tetto - Gordingen / dakbalk - Pärlin<br>  | 3  | 44x140    | 4004      |
| A-PR1 | Roof beam - Dachbalken - Panne de toit - Perlina del tetto - Gordingen / dakbalk - Pärlin<br>  | 3  | 44x140    | 3006      |
| DB    | Roof boards - Dachbretter - Voliges - Perlina per tetto - Dakhout - Katuselaud<br>   | 78 | 90x15     | 3200      |
|       | H-profile - H-profilis - Profile H - Profilo ad H - H-profiel - H-profiil<br>  | 1  | 58x90     | 1820      |
| DPL1  | Roofing felt fillet - Dachpappenleiste - Baguette de fixation du feutre bitumeux - Asse per fissaggio guaina bituminosa - Afdekljst asfaltpapier - Katusepapiilist<br> | 1  | 15x45     | 3021      |
| DPL2  | Roofing felt fillet - Dachpappenleiste - Baguette de fixation du feutre bitumeux - Asse per fissaggio guaina bituminosa - Afdekljst asfaltpapier - Katusepapiilist<br> | 2  | 15x45     | 3220      |
| DPL3  | Roofing felt fillet - Dachpappenleiste - Baguette de fixation du feutre bitumeux - Asse per fissaggio guaina bituminosa - Afdekljst asfaltpapier - Katusepapiilist<br> | 1  | 15x45     | 4019      |
| DPP-1 | Roofing felt (strip) - Dachpappe (bahnen) - Feutre bitumeux (bande) - Cartone catramato - Asfaltpapier (baan) - Katusepapp<br>   | 4  |           | 7110      |
|       | Post - Pfosten - Poteau - Piede registrabile - Stijl - Post<br>   | 1  | 70x70     | 1617      |
| DRV   | Roof edge reinforcement - Dachrandverstärkung - Corniere de renfort de bord de toit - Rinforzo x tetto - Dakrand versterking - Räästatugevdus<br>                      | 2  | 15x45     | 3505      |
| KFS-1 | Storm protection - Sturmleiste - Latte anti-tempete - Protezione anti vento - Stormverankering / beveiliging - Tormikinnitusliist<br>                                   | 5  | 22x45     | 2050      |

| Pos  | 15.11.2019 Piece list - Stückliste - Liste des pièces - Elementi - Stuklijst - Tükítabel<br>Art. Nr. 2824699 6/6  | Q   | P<br>(mm) | L<br>(mm) |
|------|---|-----|-----------|-----------|
| GL1  | Gable moulding - Giebelleiste - Planche de rive - Finitura per frontale e retro del tetto - Gevellijst - Viilulaud   | 1   | 15x120    | 3021      |
| GL2  | Gable moulding - Giebelleiste - Planche de rive - Finitura per frontale e retro del tetto - Gevellijst - Viilulaud    | 2   | 15x120    | 3250      |
| GL3  | Gable moulding - Giebelleiste - Planche de rive - Finitura per frontale e retro del tetto - Gevellijst - Viilulaud   | 1   | 15x120    | 4019      |
| HS9  | Screw for gable moulding - Schrauben für giebelleiste - Vis pour fixation planche de rive - Vite per fissare finiture davanti e dietro del tetto - Schroef voor gevellijst - Kruvi viilulauale   | 38  | 3.5x50    |           |
| HS4  | Screw for roof edge reinforcement - Schrauben für dachrandverstärkung - Vis pour fixation corniere renfort de bord de toit - Viti x rinforzo bordo tetto - Schroef voor dakrand versterking - Kruvi räästatugevdusele    | 16  | 3x30      |           |
| HS13 | Screw for post - Schrauben für pfosten - Vis de fixation des poteaux - Viti per inviare - Schroef voor stijlen - Kruvi postile   | 2   | 4x60      |           |
| HS13 | Screw for wall mounting - Schrauben für wandmontage - Vis de fixation au mur - Viti per montaggio a parete - Schroef voor wandmontage - Kruvi seinte montaažiks    | 1   | 4x60      |           |
| HS18 | Screw for roof beams - Schrauben für dachbalken - Vis pour fixation pannes de toit - Viti per perline del tetto - Schroef voor gordingen / dakbalken - Kruvi pärlinitele   | 12  | 5x120     |           |
| HS18 | Screw for wall details - Schraube für wand details - Vis pour mur details - Viti per elementi della porta - Schroef voor wand details - Kruvi seinadetailile   | 6   | 5x120     |           |
| HS18 | Screw for gable - Schrauben für giebel - Vis pour fixation des pignons - Viti per timpano - Schroef voor gevelpunt - Kruvi viilude kinnitamiseks    | 6   | 5x120     |           |
| HS20 | Screw for post height adjustment - Schrauben für regulierungsschraube für pfosten - Vis de fixation de support réglable de poteau - Viti per fissare ed aggiustare l'altezza del palo verticale - Schroef voor hoogte instelling stijlen - Kruvi vajumispoldile  | 8   | 6x50      |           |
| SH28 | Hammer block - Schlagholz - Calle de frappe - Blocco di legno da usare come cuscinetto quando si usa il martello - Slagklos - Löögiklots   | 1   |           |           |
| SFS  | Nut for storm protection - Schraubenmutter für sturmleiste - Ecrou pour latte anti-tempete - Dado x asta protezione vento - Moer voor stromverankering - Mutter tormikinnusliistule    | 10  | D6        |           |
| NF4  | Zn nail for roof - Zn nagel für dachbretter - Pointe pour fixation voliges de toit - Chiodi x perline tetto - Spijker(nagel) voor dakhout - Nael katuselauale    | 418 | 2x50      |           |
| NF5  | Zn nail for roofing felt fillet - Zn nagel für dachpappenleiste - Pointe pour baguette de fixation feutre bitumeux - Chiodi x carta bituminosa x tetto - Spijker(nagel) voor asfaltpapier afdekljst - Papiliistunael   | 32  | 2x40      |           |
| NF6  | Roofing nails for roofing felt - Nägel für dachpappe - Pointe pour fixation feutre bitumeux - Chiodi per cartone catramato - Asfaltnagel - Papinael    | 250 | 2.8x15    |           |
| BFS  | Bolt for storm protection - Bolzen für sturmleiste - Boulon pour latte anti-tempete - Bullone x asta protezione vento - Bout voor stormankerlat - Puidupolt tormikinnusliistule    | 10  | 6x60      |           |
| DFS  | Washer for storm protection - Dichtscheibe für sturmleiste - Rondelle pour latte anti-tempete - Rondella x asta protezione vento - Afdichtring voor storm strip - Seib tormikinnusliistule   | 10  | D6        |           |
|      | Post height adjustment - Regulierungsschraube für pfosten - Support réglable de poteau - Piede registrabile in altezza - Stelschroef voor stijlpost - Vajumispolt    | 1   | D20       |           |
|      | Door - Tür - Porte - Porte - Deur - Uks 14.94x1850 TUK.3.030.MXVP.MX28 MXGA+28  | 1   |           |           |
|      |   |     |           |           |
|      |   |     |           |           |
|      |   |     |           |           |

| Pos | Piece list - Stückliste - Liste des pièces - Elementi - Stuklijst - Tükítabel<br>14.94x1850 TUK.3.030.MXVP.MX28 MXGA+28   | 1/2   | Q | P<br>(mm) | L<br>(mm) |
|-----|---|---|---|-----------|-----------|
|     | <p>Glass size - Glasgröße - Taille de la vitre - Misura del vetro - Glas afmeting - Klaasi mõõt: 502x467 mm</p>   <p>1418x1792 mm</p> |   |   |           |           |
| 1   | Upper door jamb - Türrahmen oben - Cadre de porte supérieur -<br>Telaio superiore della porta - Bovendorpel - Ukse ülemine leng   |  | 1 | 66x100    | 1438      |
| 2   | Left door jamb - Türrahmen links - Cadre de porte gauche -<br>Telaio montante sinistro della porta - Linkerstijl deurframe - Ukse vasak leng  |  | 1 | 66x80     | 1850      |
| 3   | Right door jamb - Türrahmen rechts - Cadre de porte droit -<br>Telaio montante destro della porta - Rechterstijl deurframe - Ukse parem leng  |  | 1 | 66x80     | 1850      |
| 4   | Doorstep - Swelle - Barre de seuil -<br>Soglia della porta - Deurdorpel - Lävepakk  |  | 1 | 18x18     | 1418      |
| 5   | Connection strip - Deckleiste - Baguette de battement - Profilo verticale della<br>porta - Stulplijst - kokkuvaltsiliist  |  | 1 | 13x32     | 1812      |





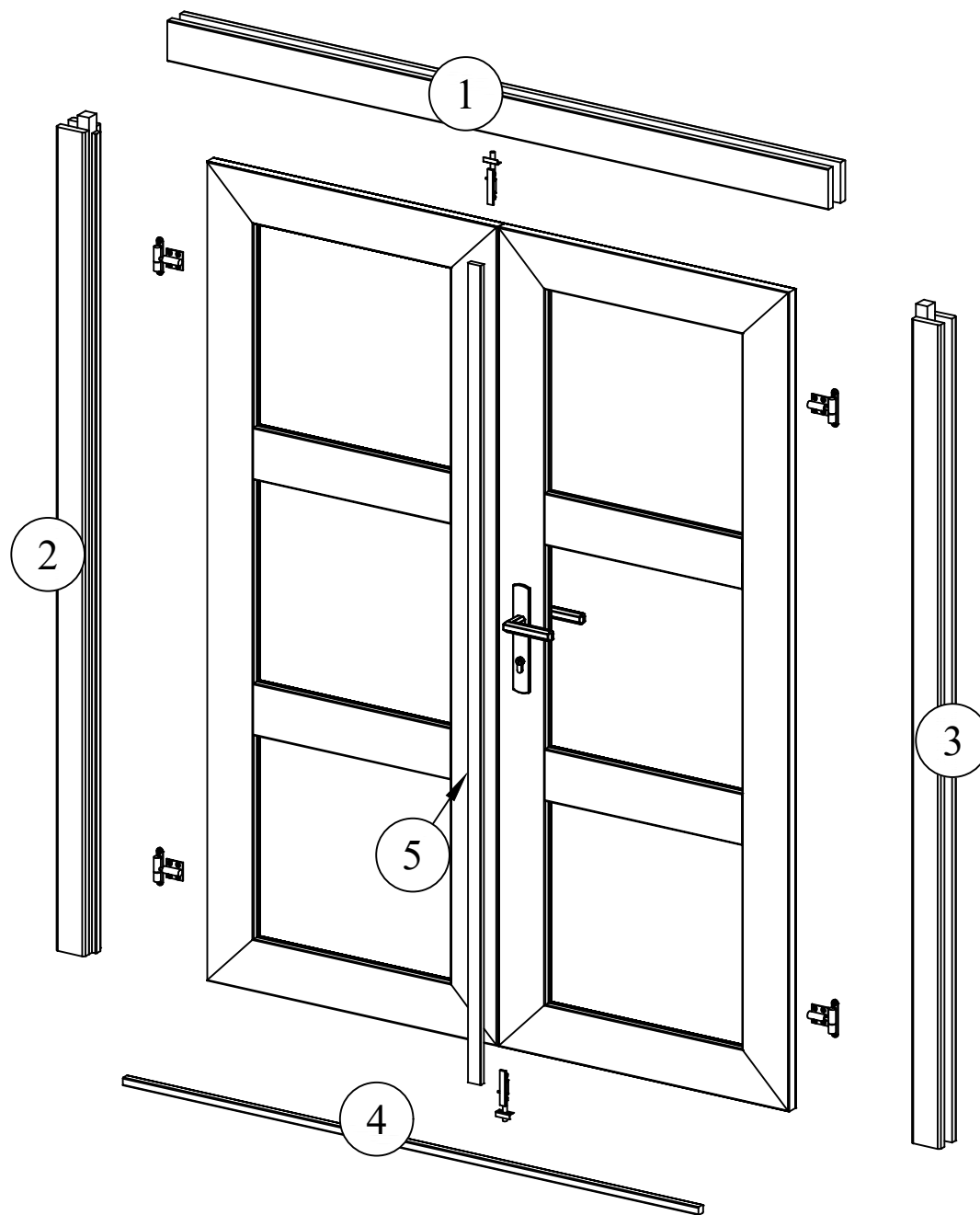

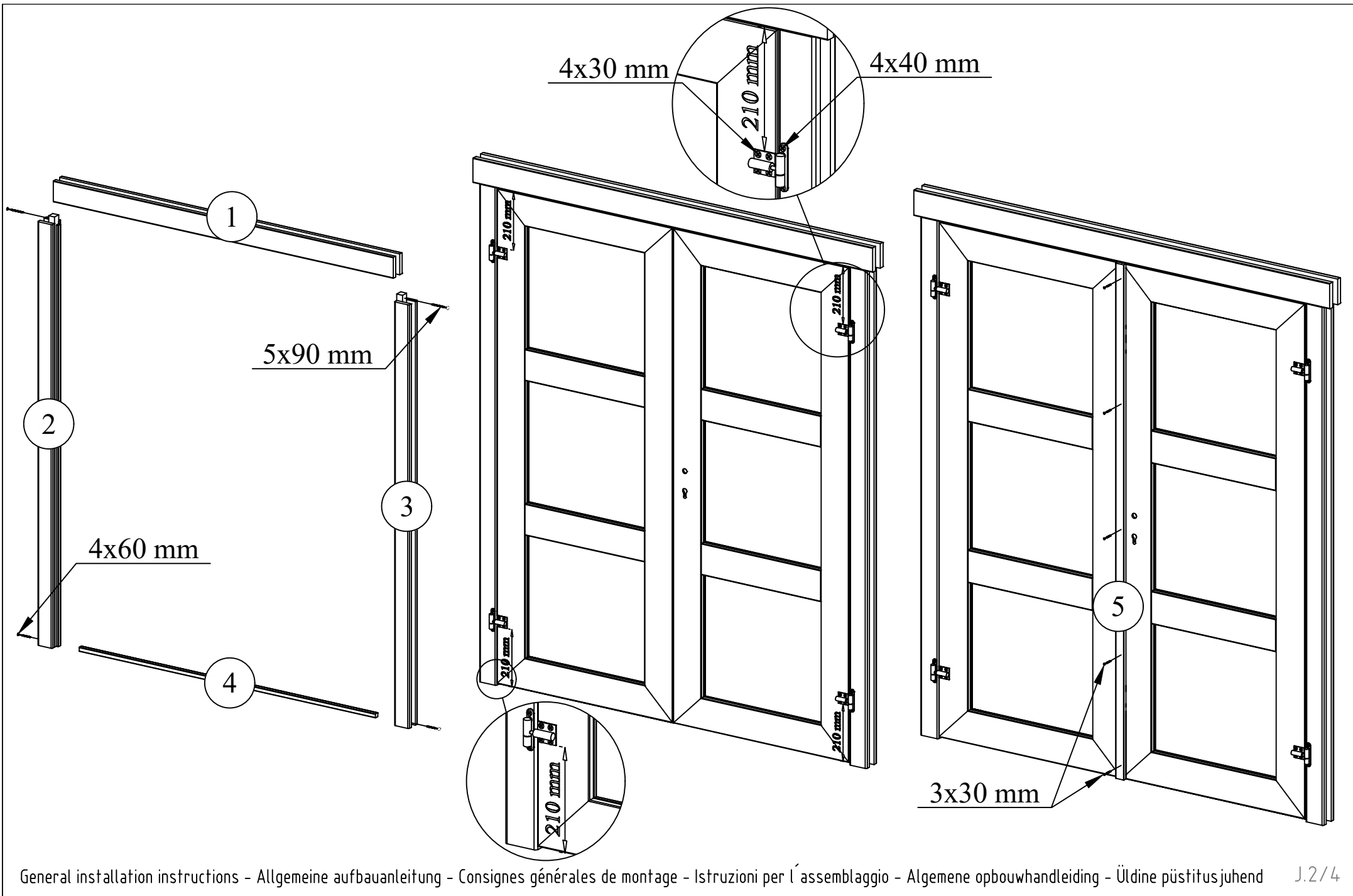

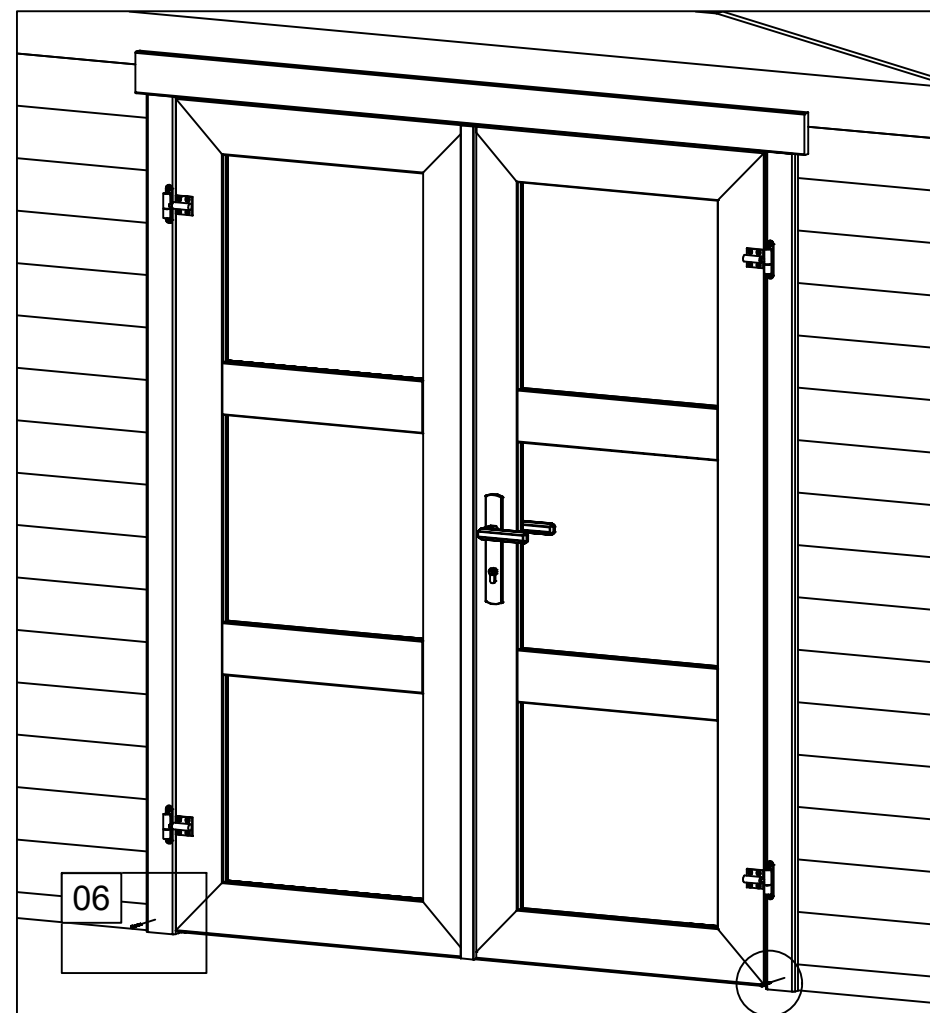
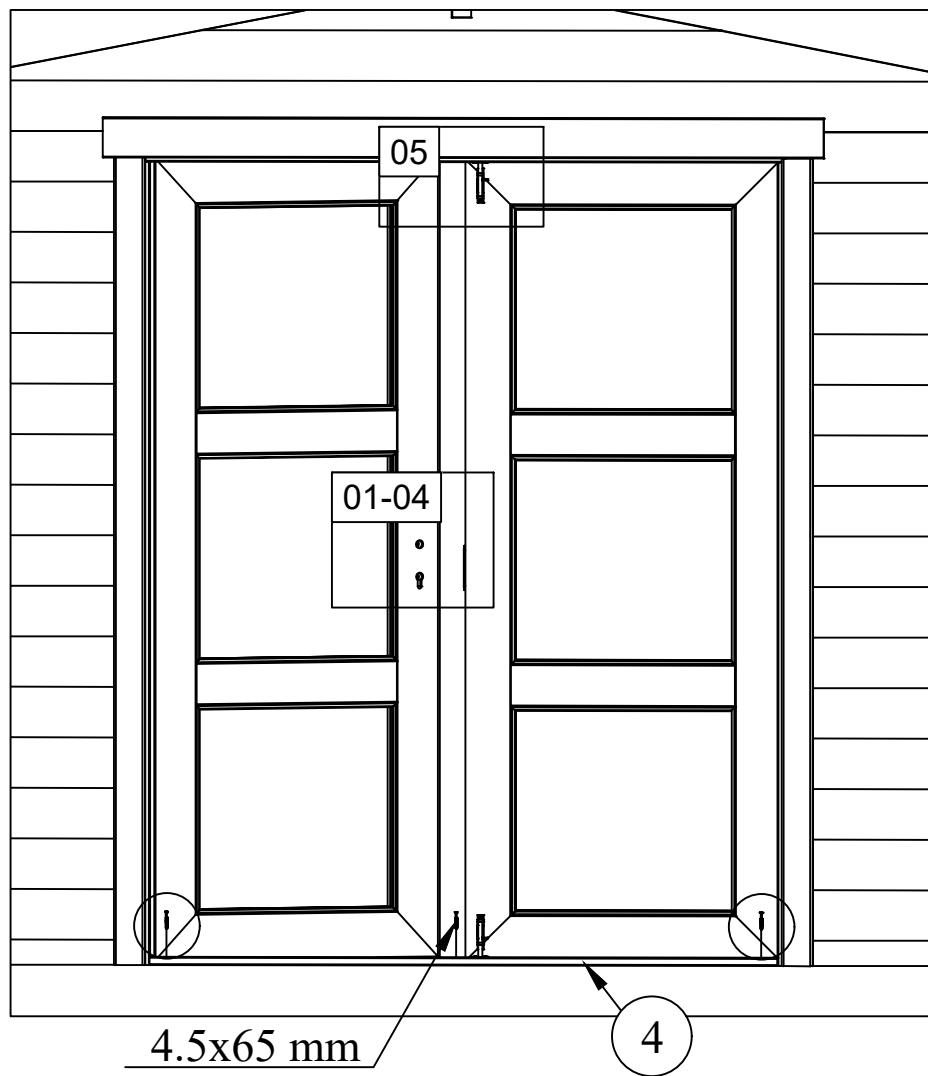

01

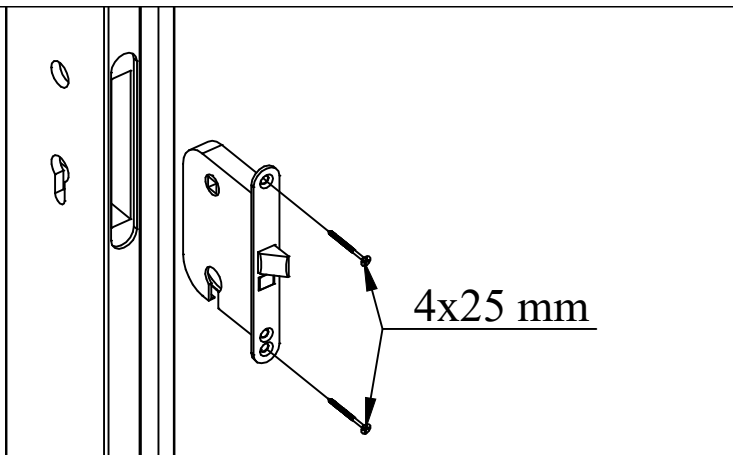

04

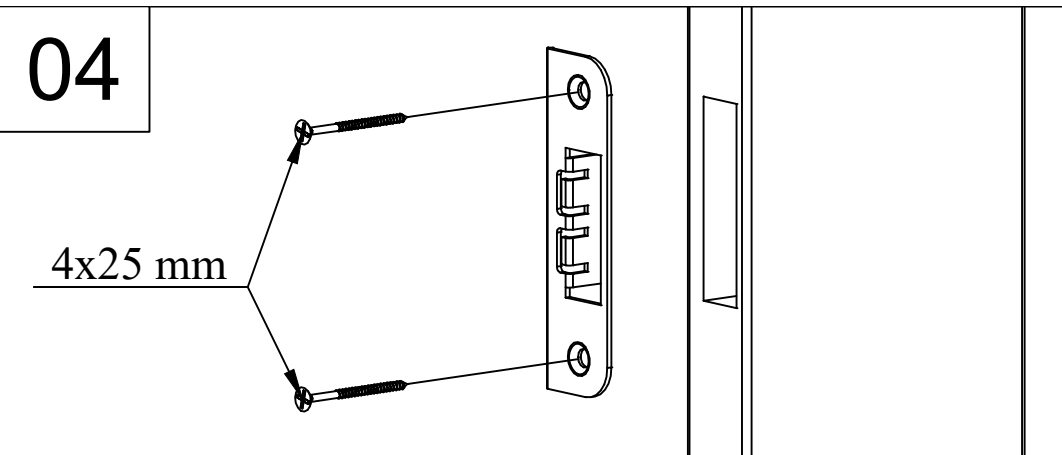

02

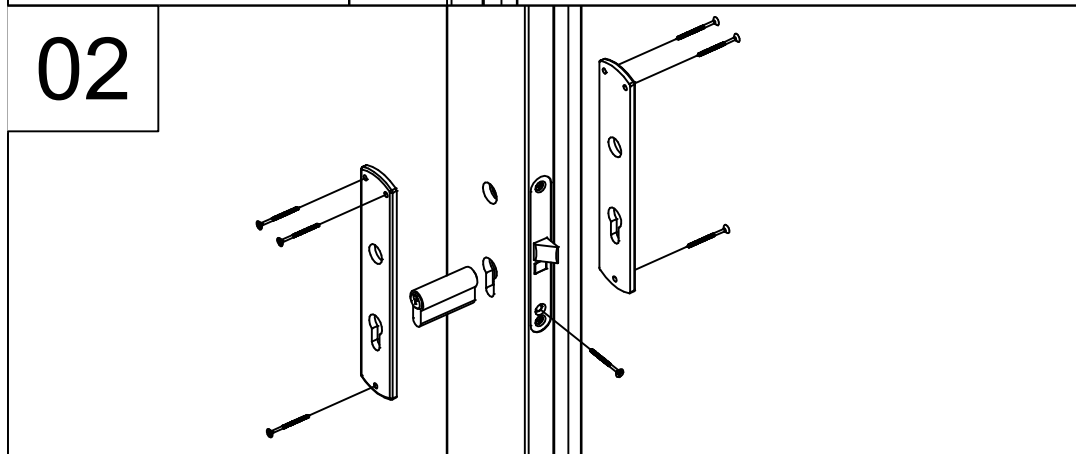

05



03

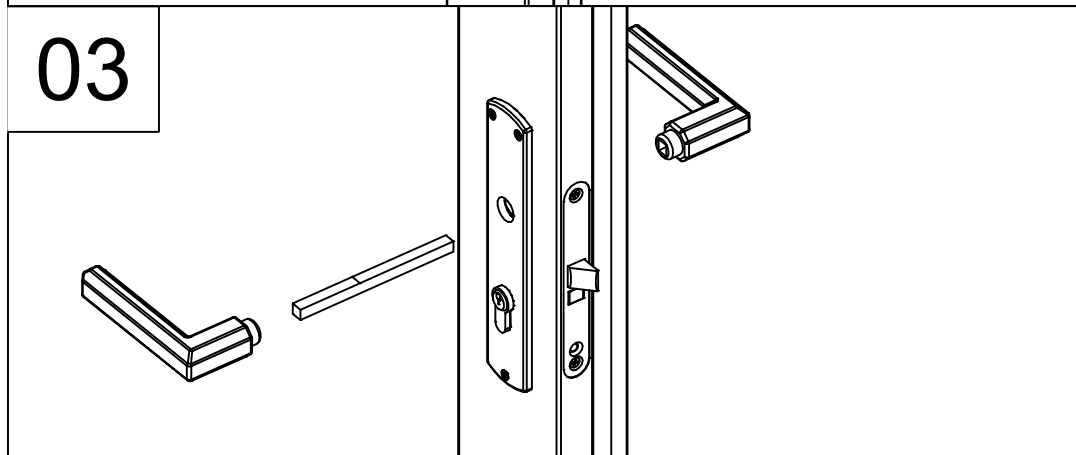

06

