

Mehr Produkte finden Sie  
in unserem Katalog!

Art. 714 200



# Geräteschrank 20-A

20 mm / 84x84 cm / 0,71 m<sup>2</sup>

## DIMENSIONEN

	Bohlenstärke	20 mm
	Innenmaß	80x80 cm
	Sockelmaß	84x84 cm
	Gesamtmaß	90x102 cm
	Grundfläche	0,71 m <sup>2</sup>
	Rauminhalt	1,3 m <sup>3</sup>
	Wandhöhe vorne (A) / hinten (B) vorne hinten	174 cm 200 cm
	Dachüberstand vorne seitlich hinten	9 cm 3 cm 9 cm

## DACH

	Dachneigung	12°
	Dachfläche	1,1 m <sup>2</sup>
	Dachbretter inkl. Dachpappe	20 mm



## TÜR/ FENSTER

	Einzeltür (Vollholz)	74x165 cm
--	----------------------	-----------

## FUSSBODEN

	Fußbodenbretter	20 mm
--	-----------------	-------

## VERPACKUNG

	Paketabmessung	198x104x45 cm
	Paketgewicht	70 kg

## ZUBEHÖR (zzgl.)

	Dachschildel-Set Nr. 1 1 Rolle Dichtungsbahn Einlegeboden
--	---

5 JAHRE  
GARANTIE



## Grundriss

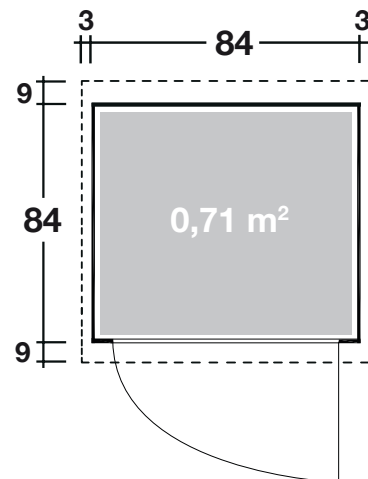

Weitere Informationen finden Sie unter: [www.finnhaus.de](http://www.finnhaus.de) oder im aktuellen Katalog.  
Technische Änderungen, Druckfehler und Irrtümer vorbehalten.