

*Internal room kit M*  
*Art. Nr. 9901400*  
*1/17*

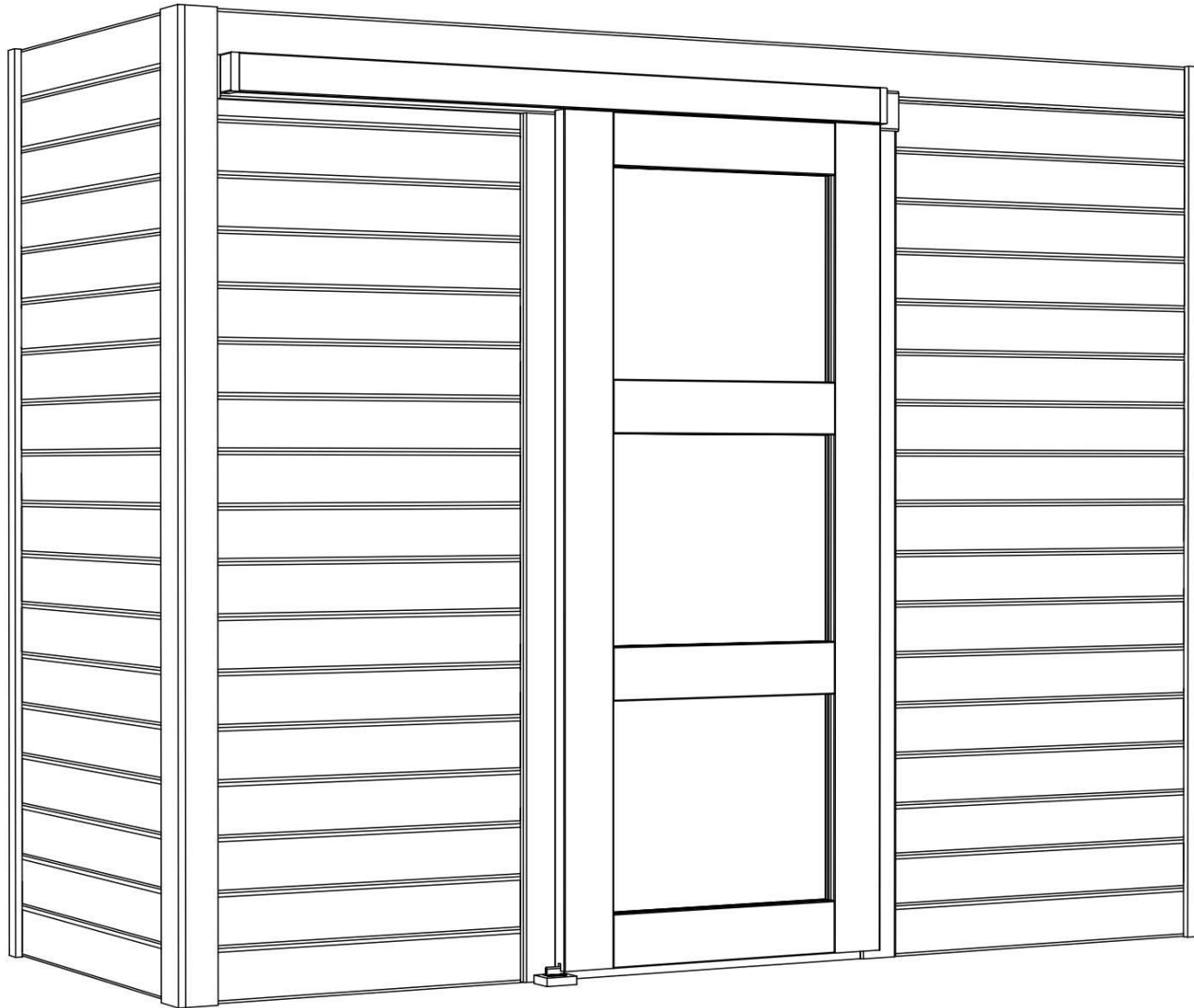

21.01.2020

Art. Nr. 9901400

Groundplan - Grundplan - Plan de masse - Planimetria - Plattegrond - Põhiplaan

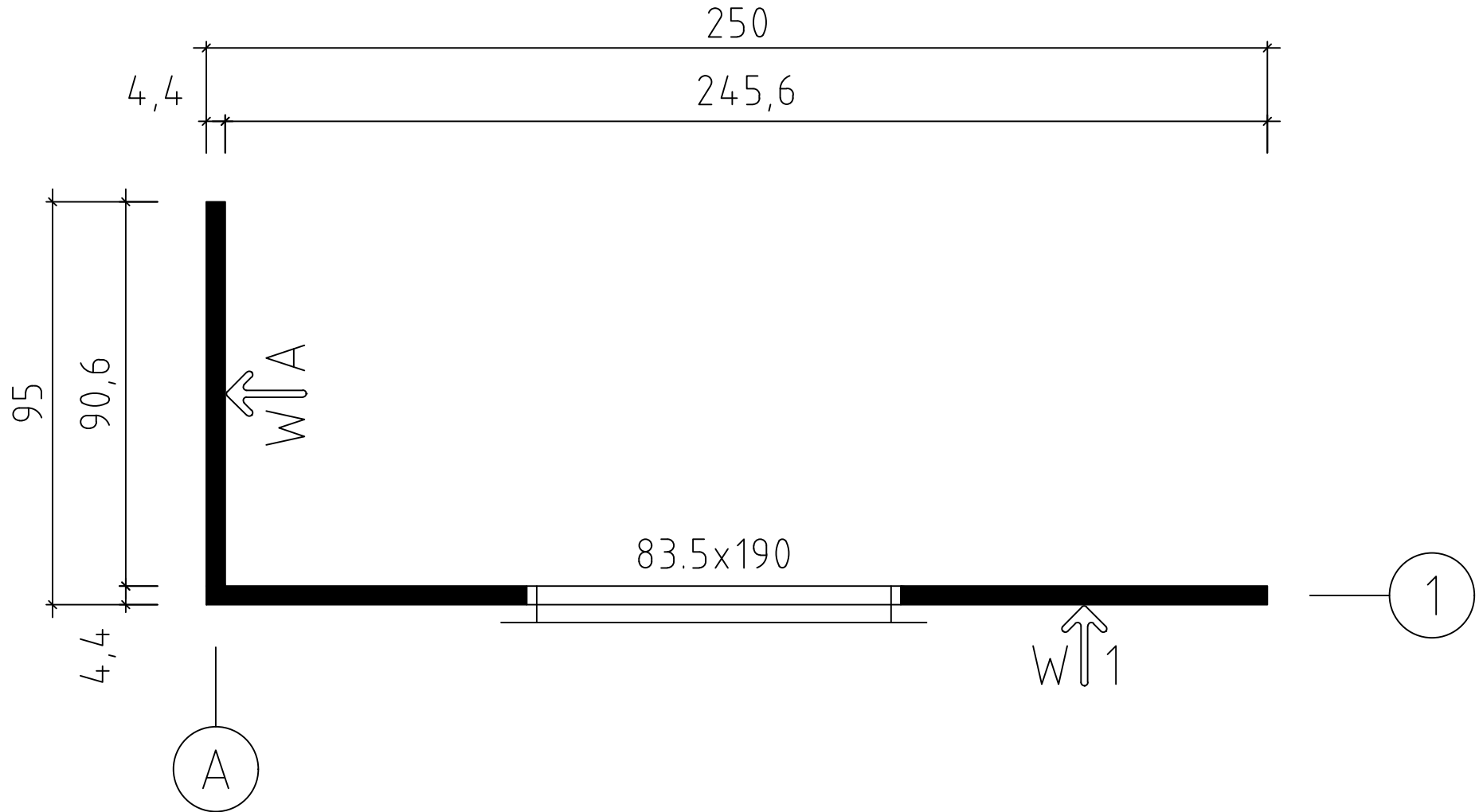





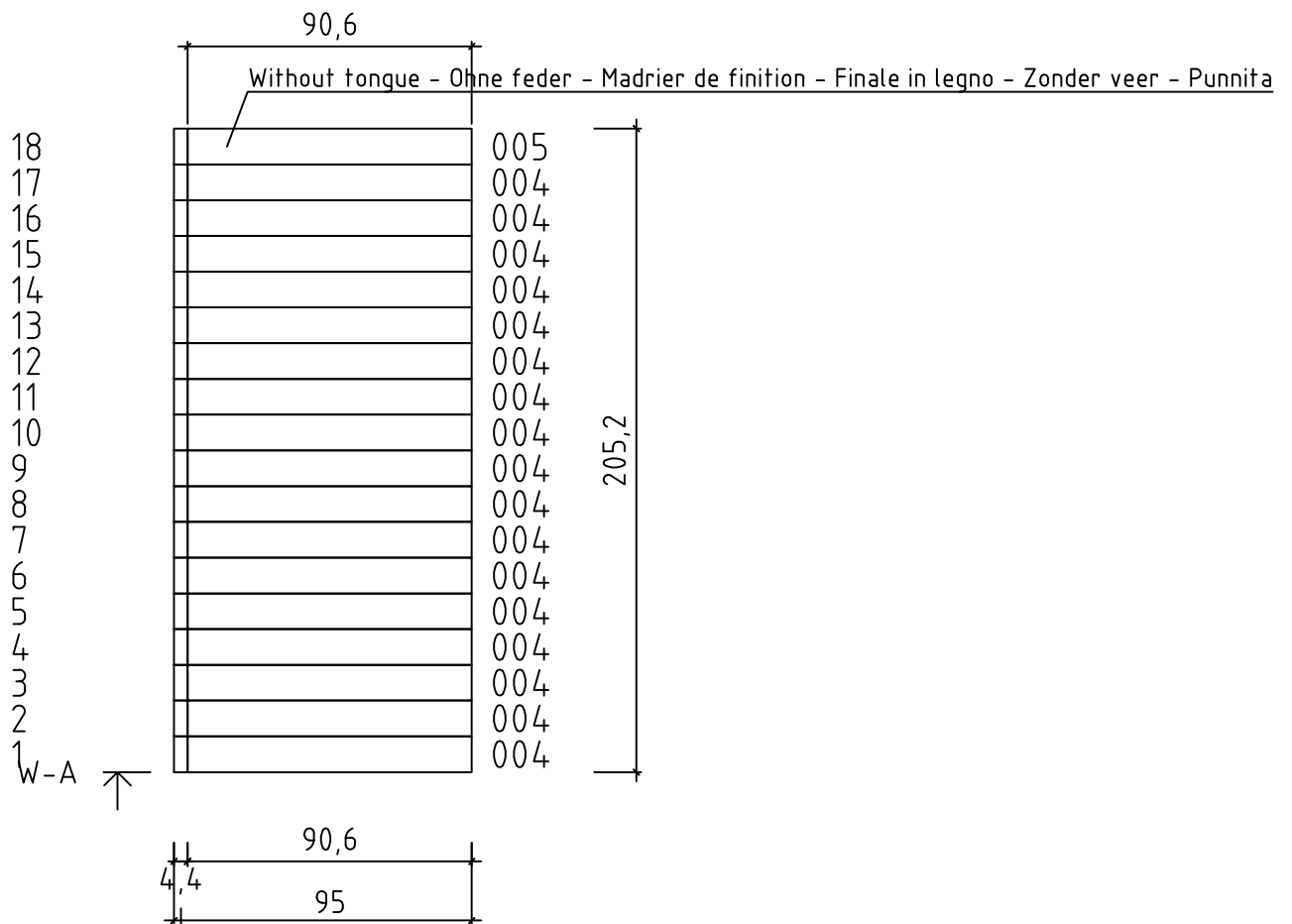
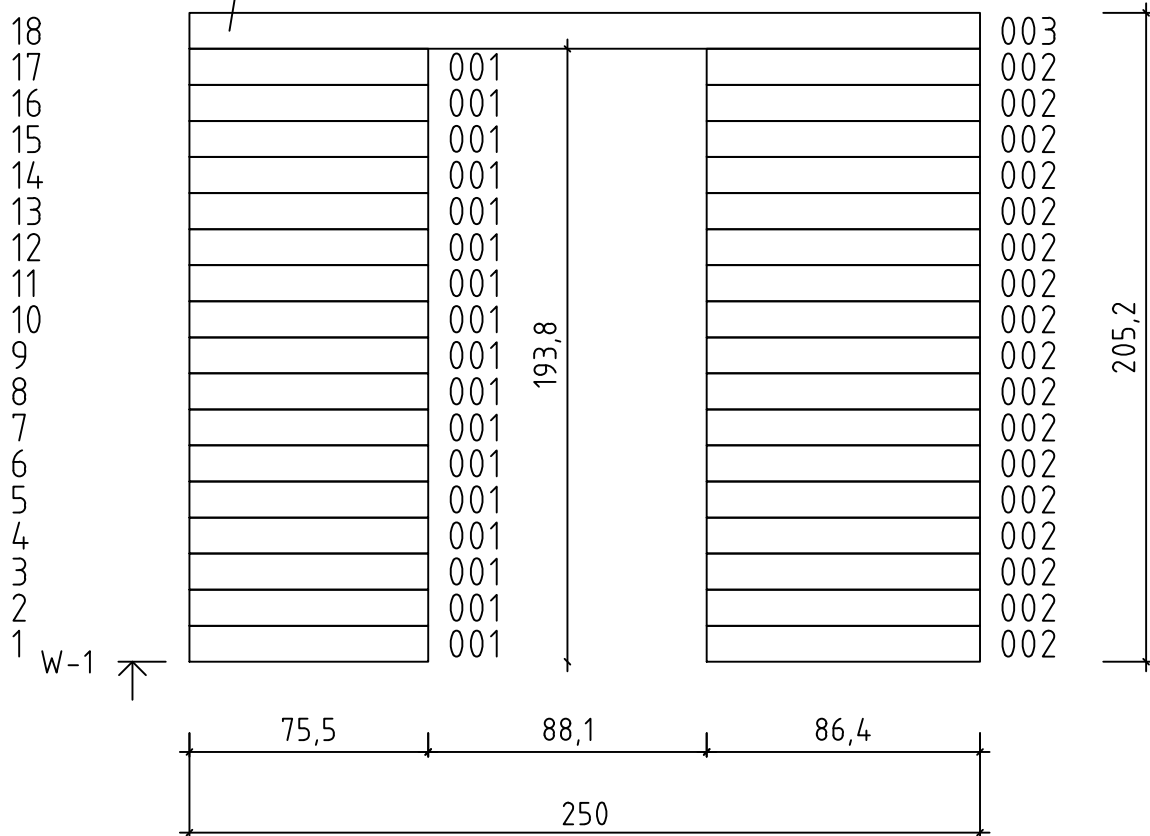



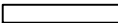

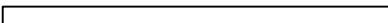

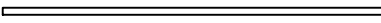
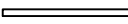
Art. Nr. 9901400

Without tongue - Ohne feder - Madrier de finition - Finale in legno - Zonder veer - Punnita

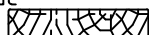
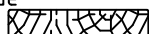
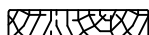
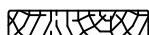

1

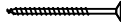
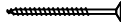
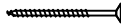
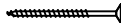
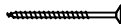
| Pos  | 21.01.2020 Piece list - Stückliste - Liste des pièces - Elementi - Stuklijst - Tükítabel<br>Art. Nr. 99014.00 4/17   | Q   | P<br>(mm) | L<br>(mm) |
|------|--|-----|-----------|-----------|
| 001  |   | 17  | 44x114    | 755       |
| 002  |   | 17  | 44x114    | 864       |
| 003  |   | 1   | 44x114    | 2500      |
| 004  |   | 17  | 44x114    | 906       |
| 005  |   | 1   | 44x114    | 906       |
| RV2  | Lath - Pfetten - Liteau - Piccola asse - Gordingen - Roov<br>   | 2   | 44x44     | 2456      |
| RV1  | Lath - Pfetten - Liteau - Piccola asse - Gordingen - Roov<br>   | 2   | 44x44     | 818       |
| DB   | Ceiling boards - Deckenbrett - Voliges sous plafond - Tavole per piano<br>soffitto - Dakhout - Laelaud    | 28  | 90x15     | 906       |
|      | Ceiling fillet - Deckeleiste - Profil de finition sous plafond - Massello per<br>soffitto - Dak afdeklijst - Laeliist   |     | 18x18     | 14        |
| DL   | Batten - Deckleiste - Profils de finition angles a l'exterieur - Asse - Afdek<br>lijst - Katteliist   | 2   | 15x40     | 2052      |
| TS1  | Rail holder for sliding door - Schiene für schiebetür, oben - Rail support pour<br>porte coulissante - Supporto per porta scorrevole - Rails houder voor<br>schuifdeur - Lükandukse kinniti   | 1   | 28x34     | 1500      |
| TS2  | Rail holder cover for sliding door - Schiene für schiebetür, oben - Le couvrir de<br>rail support pour porte coulissante - Supporto di copertura per porta<br>scorrevole - Rails houder afdekkap voor schuifdeur - Lükandukse kinniti kate  | 2   | 18x80     | 52        |
| TS3  | Rail holder cover for sliding door - Schiene für schiebetür, oben - Le couvrir de<br>rail support pour porte coulissante - Supporto di copertura per porta<br>scorrevole - Rails houder afdekkap voor schuifdeur - Lükandukse kinniti kate  | 1   | 18x80     | 1500      |
| CF1  | Corner fillet - Deckleiste - Profils de finition angles a l'exterieur - Massello<br>d'angolo - (hoek)lijst - Nurgaliist   | 1   | 15x70     | 2052      |
| CF2  | Corner fillet - Deckleiste - Profils de finition angles a l'exterieur - Massello<br>d'angolo - (hoek)lijst - Nurgaliist   | 1   | 15x90     | 2052      |
| CS   | Corner stud - Eckpfosten - Poteaux d'angle pour fixation des madriers -<br>Perno angolare - Hoek staander (kolom) - Nurgapost   | 4   | 44x44     | 2000      |
| FF   | Fixing fillet - Fixirungsleiste - Profil de fixation - Massello di fissaggio -<br>Bevestiging lijstwerk - Tenderliist   | 14  | 18x44     | 2714      |
| HS7  | Screw for sliding wall tie - Schieberegler für wand - Sabot métallique pour<br>fixation mur - Vite per fissare scorrimento a c su slitta fissata alla parete -<br>Schuifdeur instellingen wand - Kruvi seinaliugurile                       | 40  | 3.5x20    |           |
| HS4  | Screw for corner fillet - Schraube zur befestigung deckleiste - Vis pour<br>profils de finition angles a l'exterieur - Viti per massellino d'angolo - Schroef<br>voor afdeklijst (hoek) - Kruvi nurgaliistule                               | 28  | 3x30      |           |
| HS14 | Screw for post - Schrauben für pfosten - Vis de fixation des poteaux - Viti<br>per inviare - Schroef voor stijlen - Kruvi postile   | 10  | 4.5x80    |           |
| HS14 | Screw for wall details - Schraube für wand details - Vis pour mur details - Viti<br>per elementi della porta - Schroef voor wand details - Kruvi seinte montaažiks    | 122 | 4.5x80    |           |
| HS14 | Screw for roof lath - Schraube für dachlatte - Vis pour latte - Vite per<br>listello del tetto - Schroef voor daklat - Kruvi roovile    | 18  | 4.5x80    |           |
| HS12 | Screw for ceiling boards - Schrauben für deckenbrett - Vis de fixation des<br>Voliges sous plafond - Viti per tavole per piano soffitto - Schroef voor<br>dakhout - Kruvi laelauale   | 60  | 4x40      |           |



Art. Nr. 9901400

01

01

01

90,6

245,6

HS14

CS

HS14

21.01.2020

Modern corner connection - moderne Eckverbindung - Raccord d'angle moderne - Connessione ad angolo moderna - Moderne Hoekverbinding - Kruvitav tappideta nurgähendus

6/17

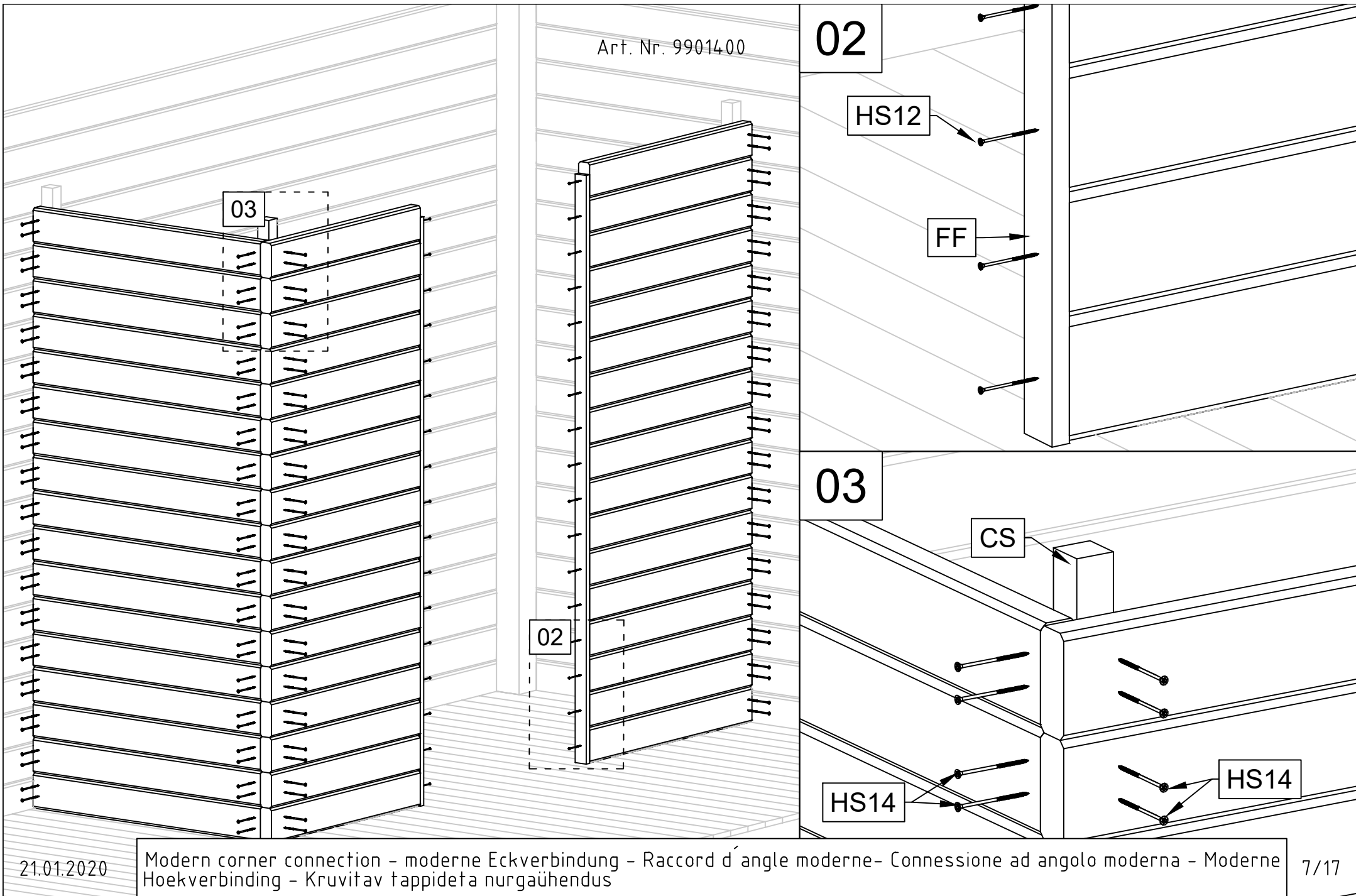

21.01.2020

Modern corner connection - moderne Eckverbindung - Raccord d'angle moderne - Connessione ad angolo moderna - Moderne  
 Hoekverbinding - Kruvitav tappideta nurgäühendus

Art. Nr. 9901400

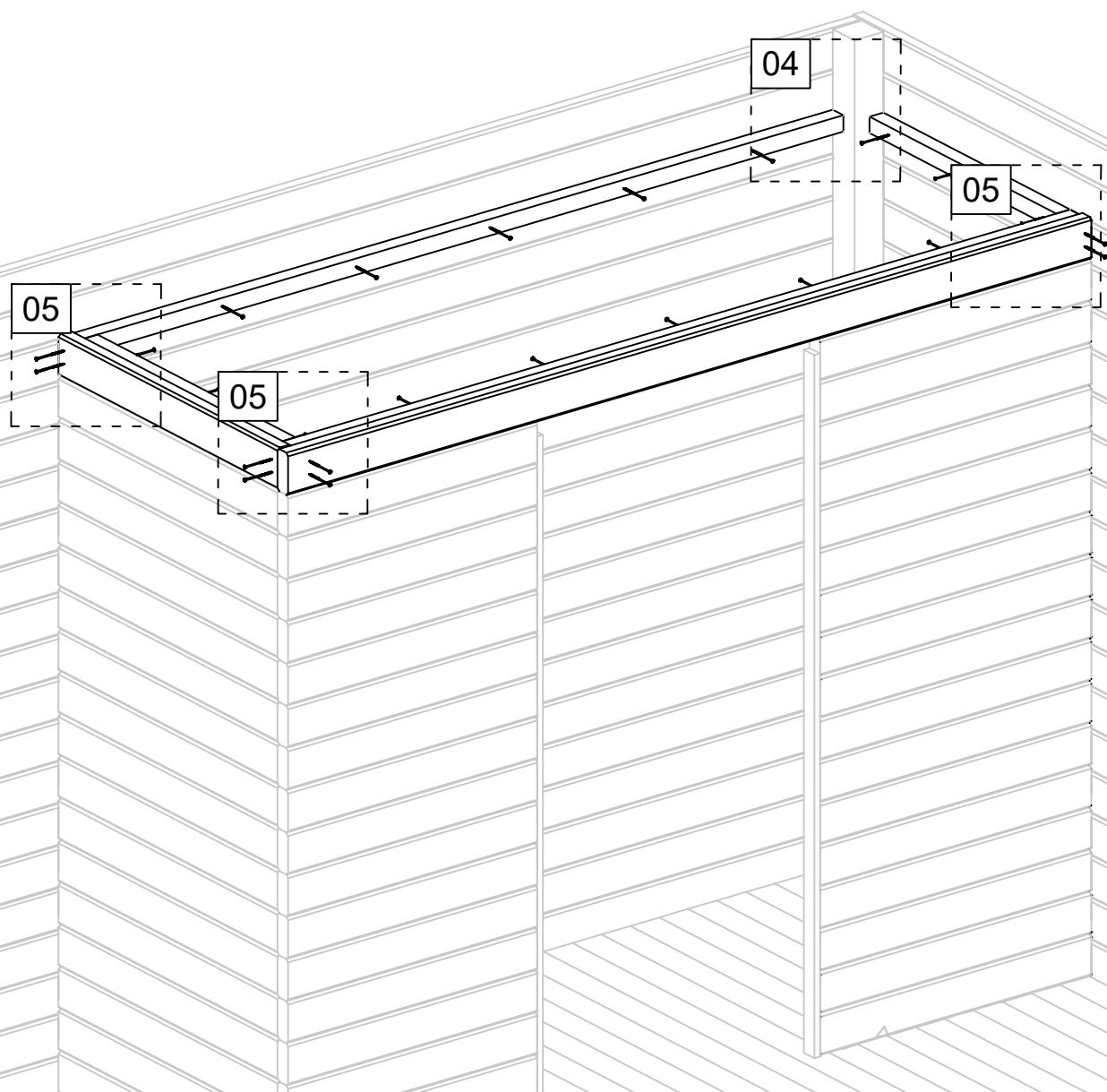

04

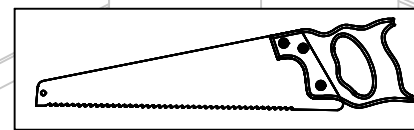

RV2

RV1

HS14

HS14

05

RV2

RV2

HS14

RV1

21.01.2020

Modern corner connection - moderne Eckverbindung - Raccord d'angle moderne - Connessione ad angolo moderna - Moderne Hoekverbinding - Kruvitav tappideta nurgäühendus

8/17



Art. Nr. 99014.00

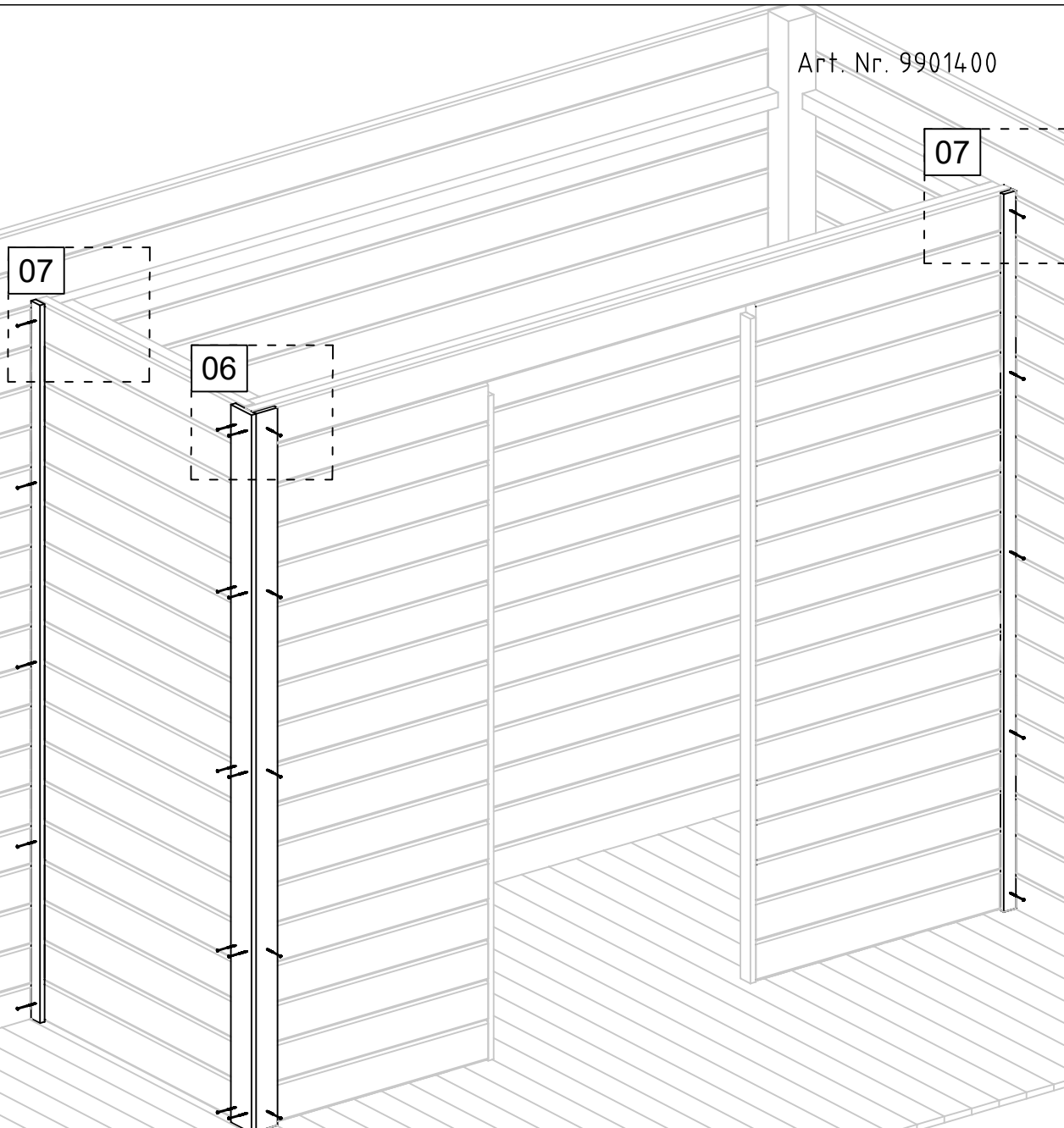

06

HS4

HS4

CF2

CF1

07

HS4

DL

21.01.2020

Modern corner connection - moderne Eckverbindung - Raccord d'angle moderne - Connessione ad angolo moderna - Moderne  
Hoekverbinding - Kruvitav tappideta nurgäühendus

9/17

Art. Nr. 9901400

08/09

08/09

08

DB

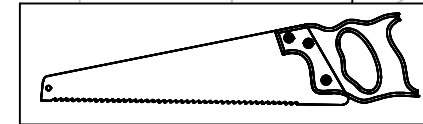

09

DB

HS12

21.01.2020

Modern corner connection - moderne Eckverbindung - Raccord d'angle moderne - Connessione ad angolo moderna - Moderne Hoekverbinding - Kruvitav tappideta nurgäühendus

10/17

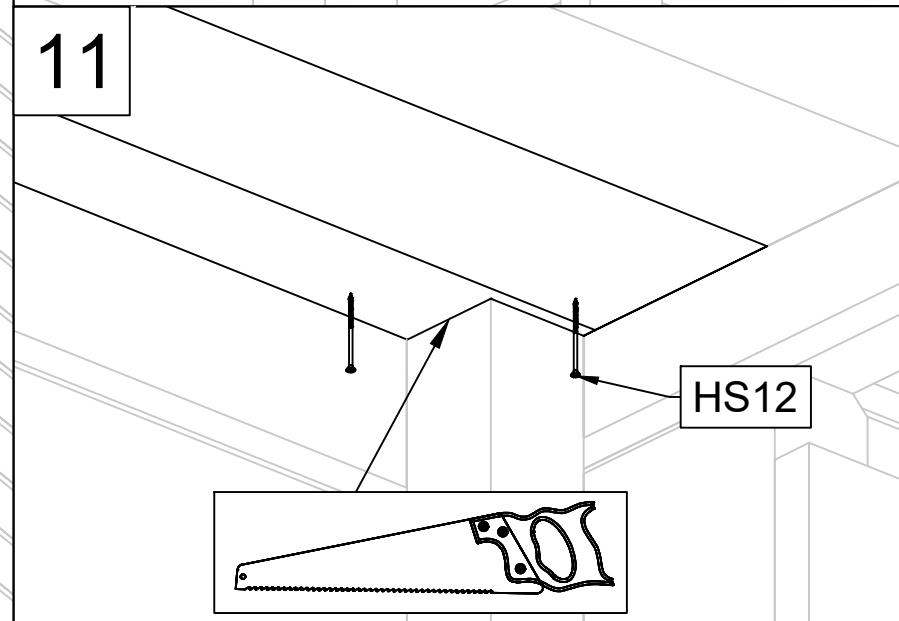
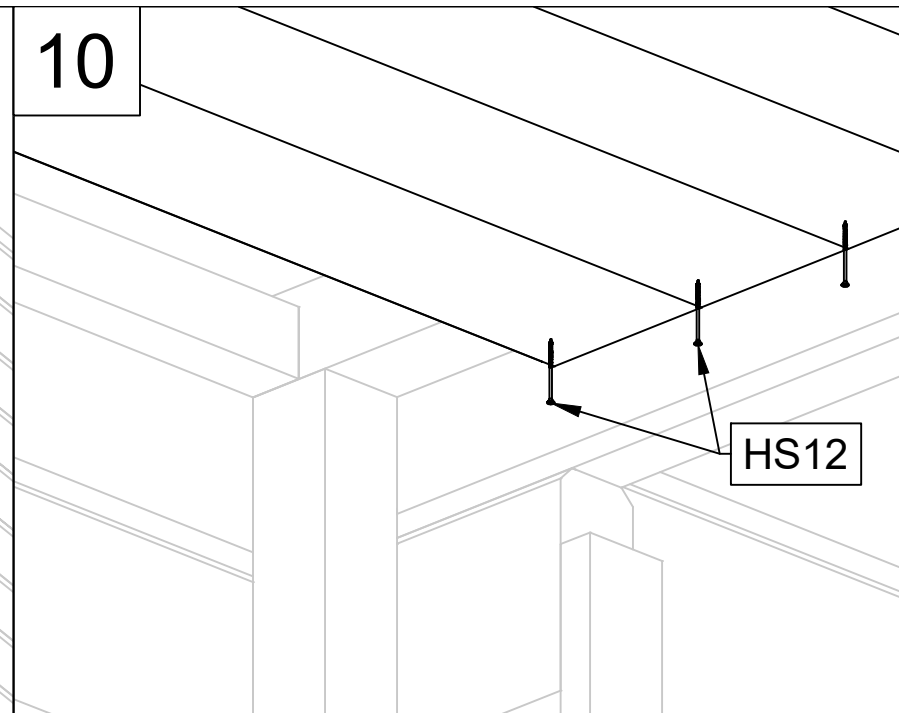
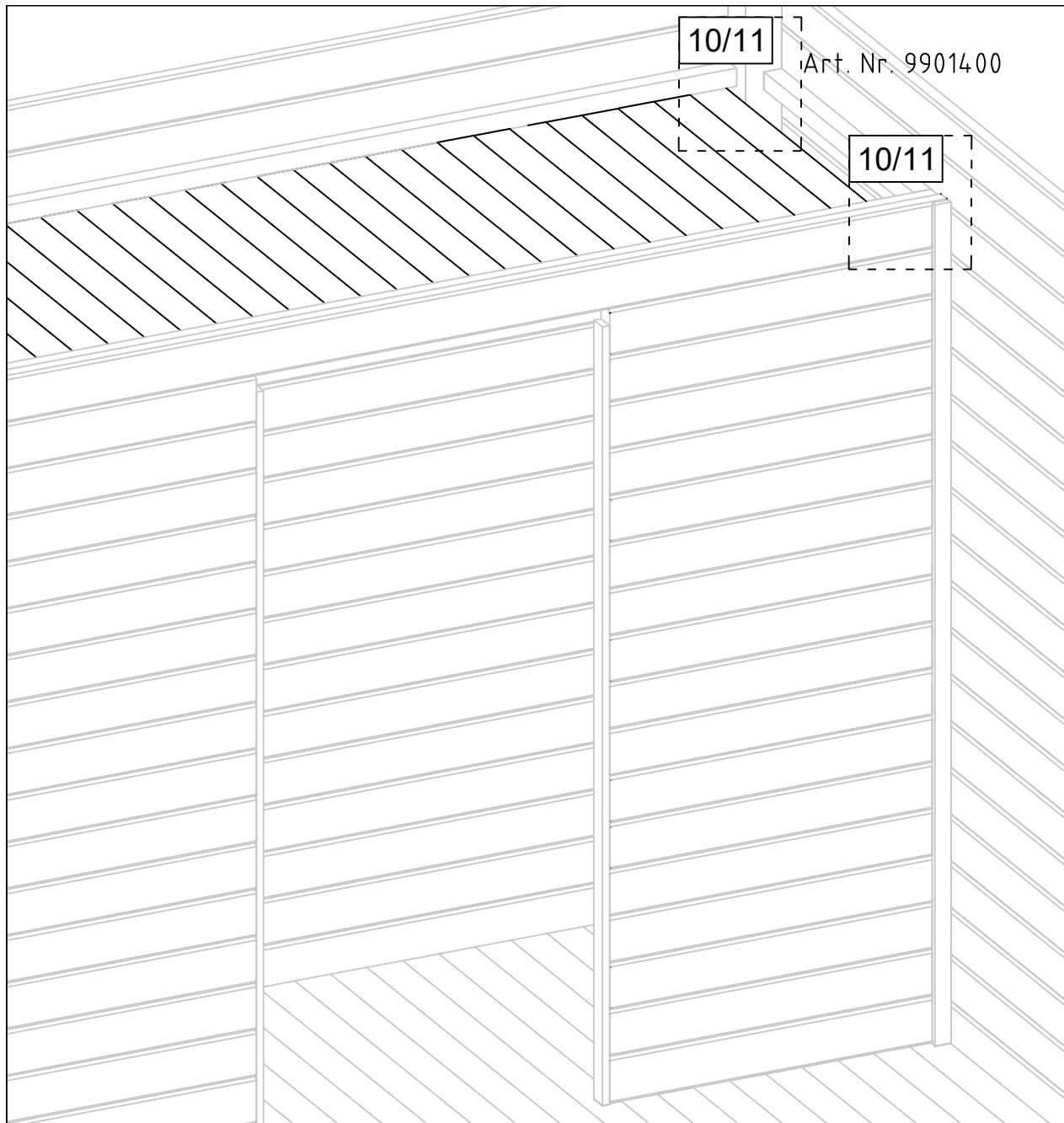

21.01.2020

Modern corner connection - moderne Eckverbindung - Raccord d'angolo moderne - Connessione ad angolo moderna - Moderne  
 Hoekverbinding - Kruvitav tappideta nurgäühendus

11/17

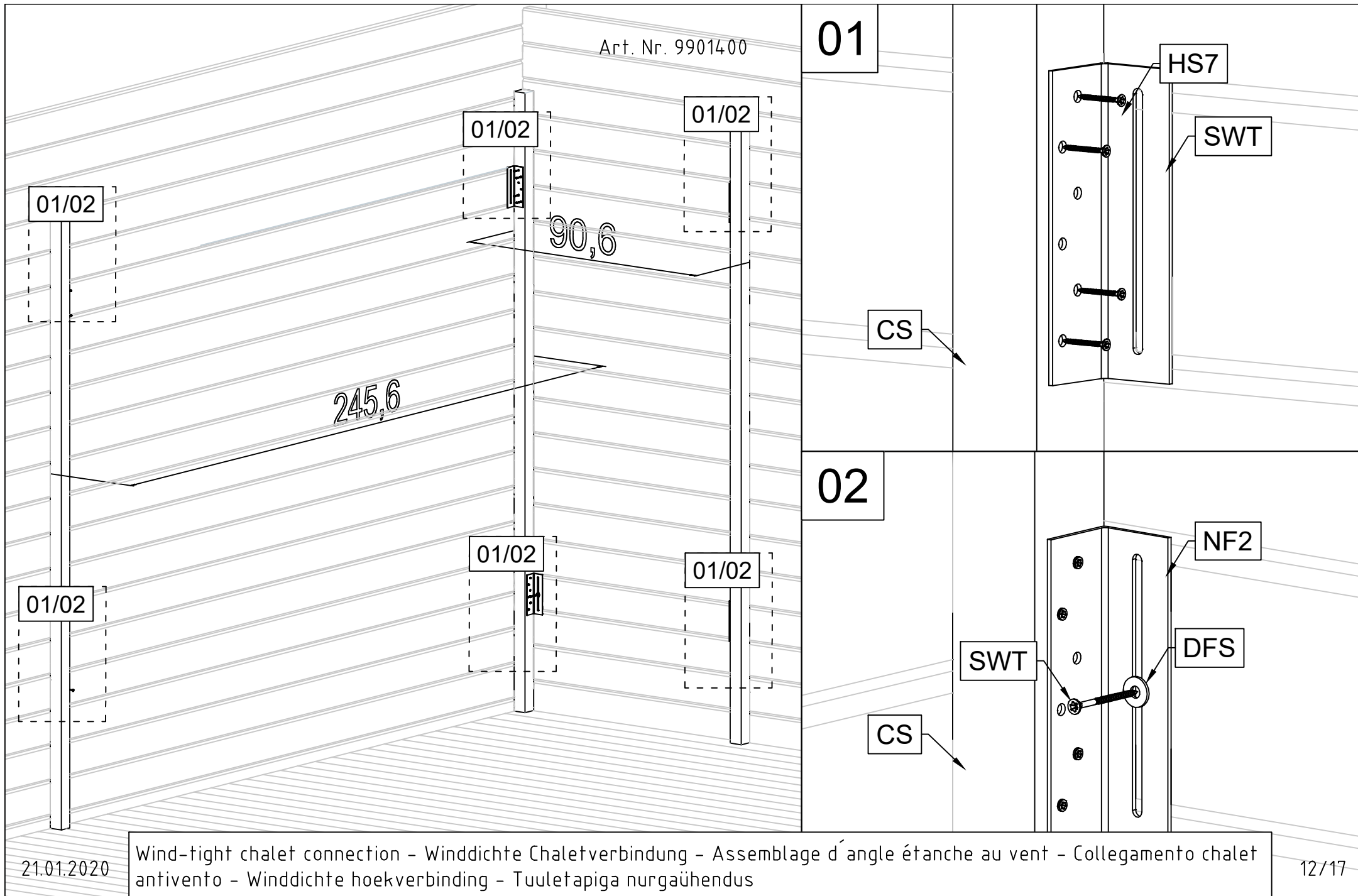

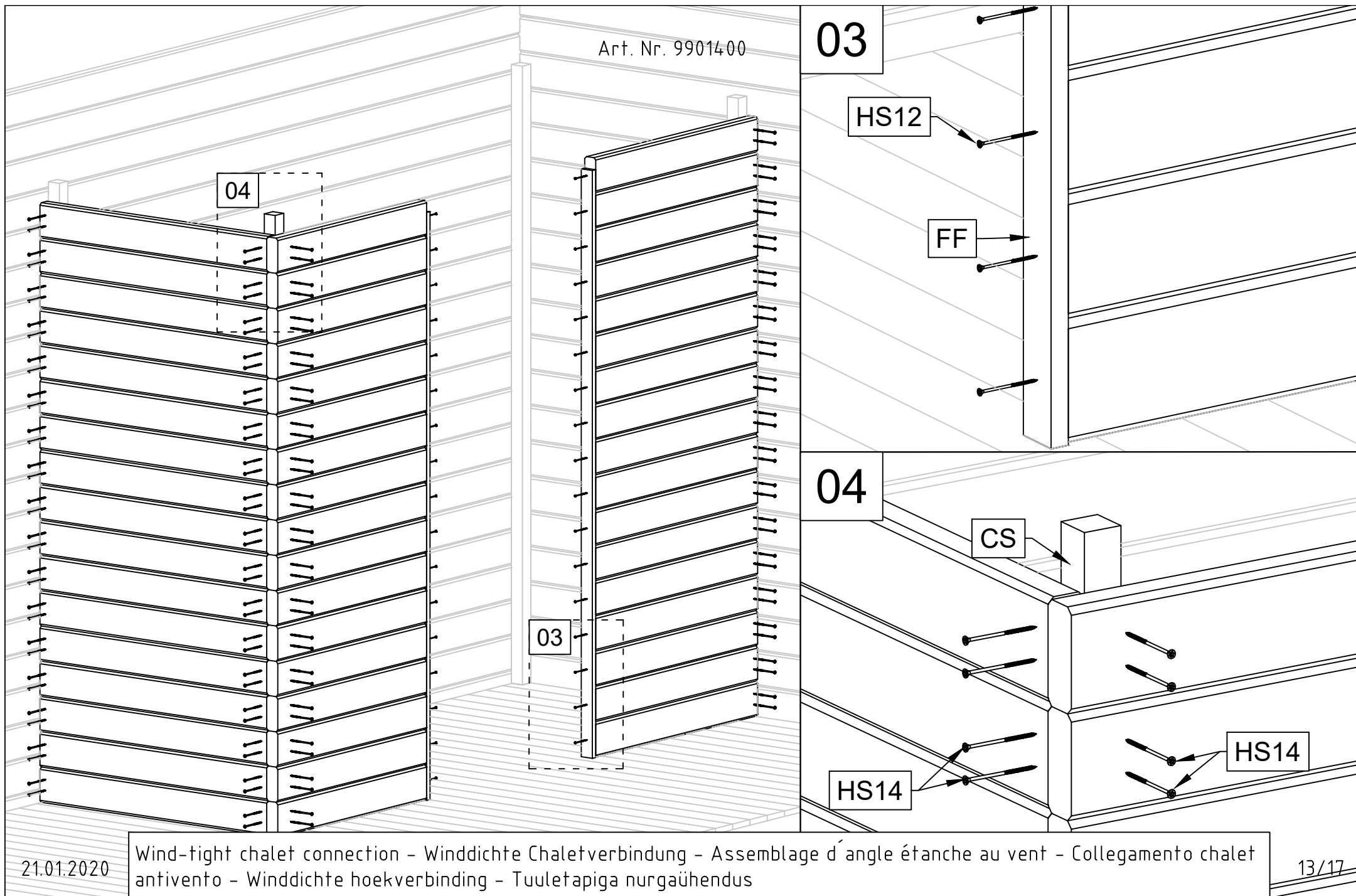

Art. Nr. 99014.00

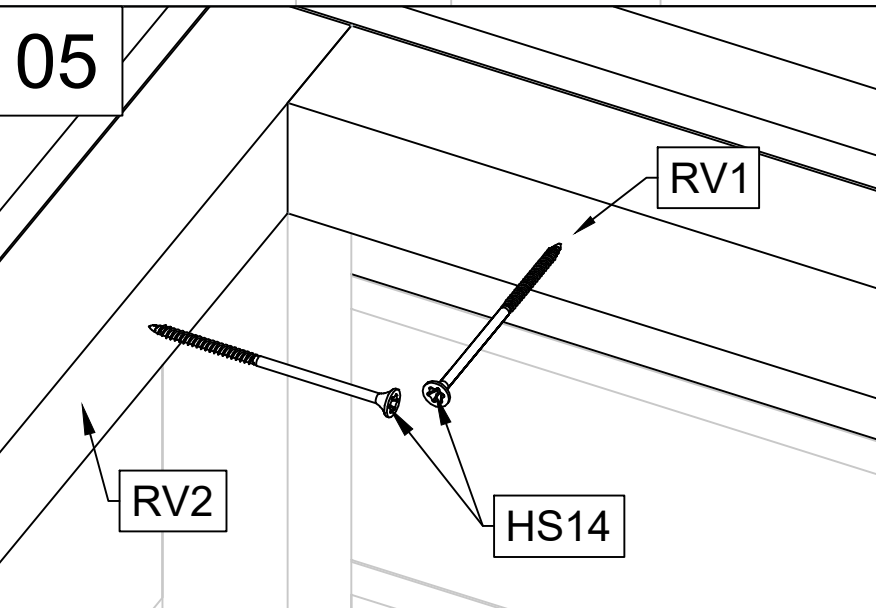
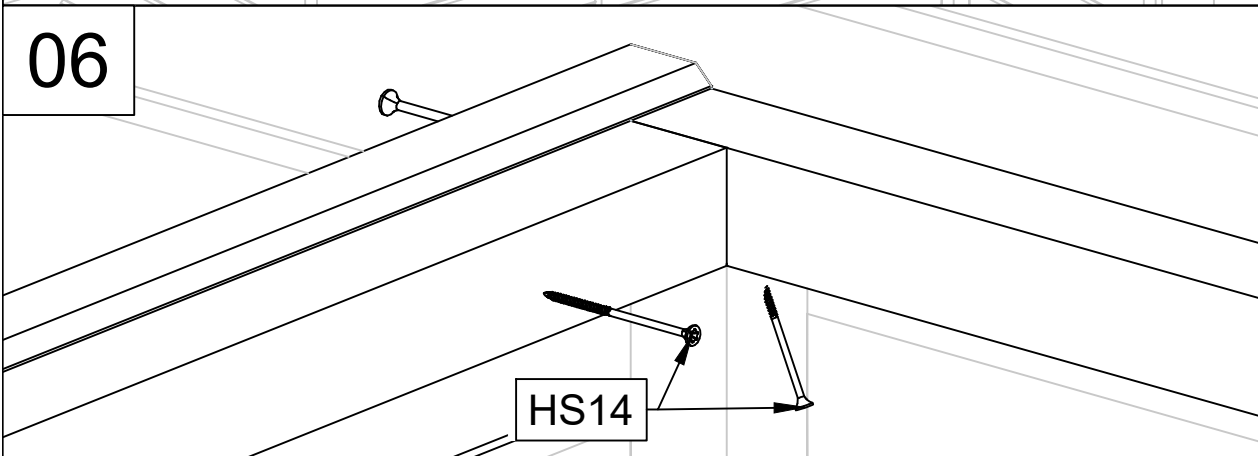
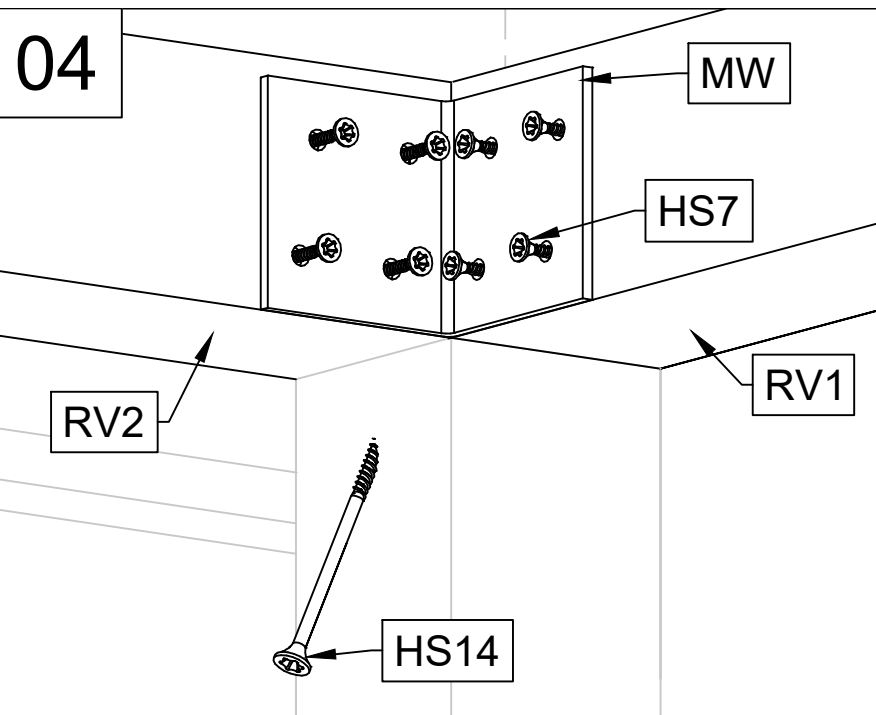
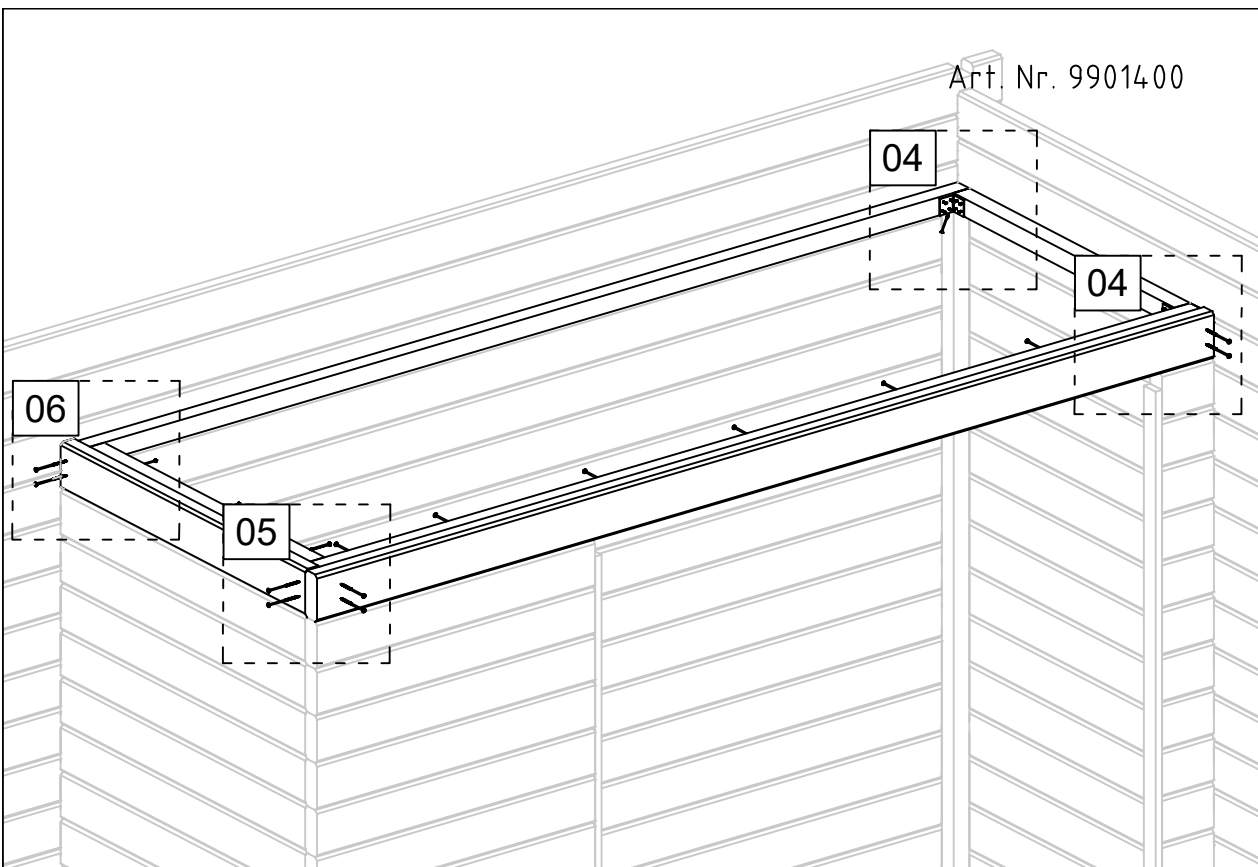

21.01.2020

Wind-tight chalet connection - Winddichte Chaletverbindung - Assemblage d'angle étanche au vent - Collegamento chalet antivento - Winddichte hoekverbinding - Tuuletapiga nurgäühendus

Art. Nr. 9901400

08

07

08

07

HS4

HS4

CF2

CF1

08

HS4

DL

21.01.2020

Wind-tight chalet connection - Winddichte Chaletverbindung - Assemblage d'angle étanche au vent - Collegamento chalet antivento - Winddichte hoekverbinding - Tuuletapiga nurgäühendus

15/17

Art. Nr. 9901400

09/10

09/10

09

DB

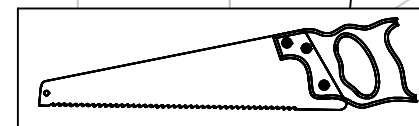

10

DB

HS12

21.01.2020

Wind-tight chalet connection - Winddichte Chaletverbindung - Assemblage d'angle étanche au vent - Collegamento chalet antivento - Winddichte hoekverbinding - Tuuletapiga nurgäühendus

16/17



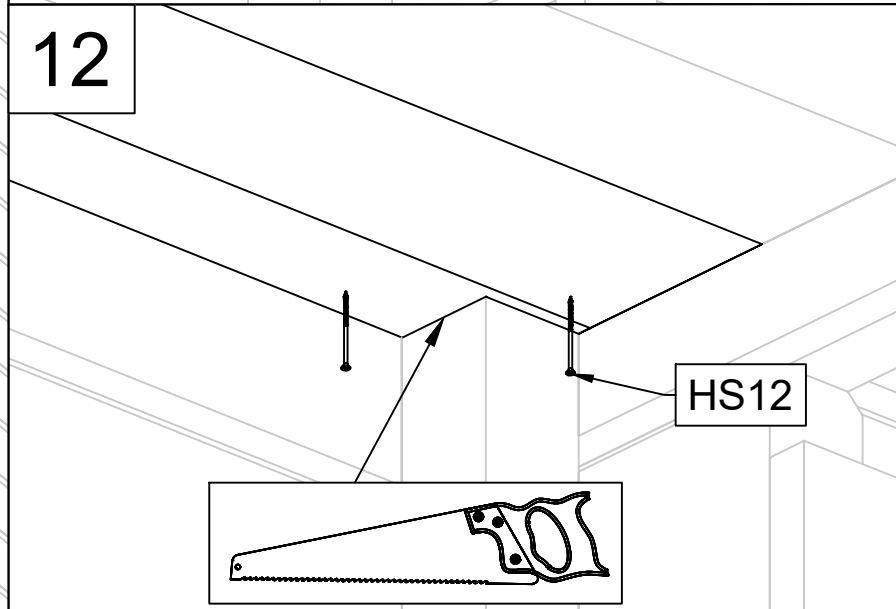
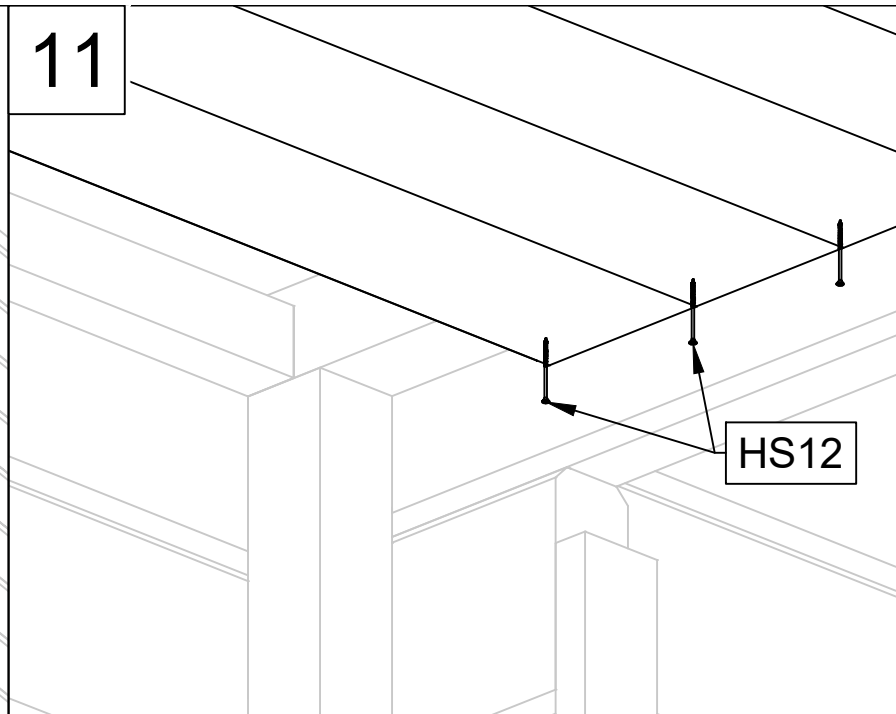
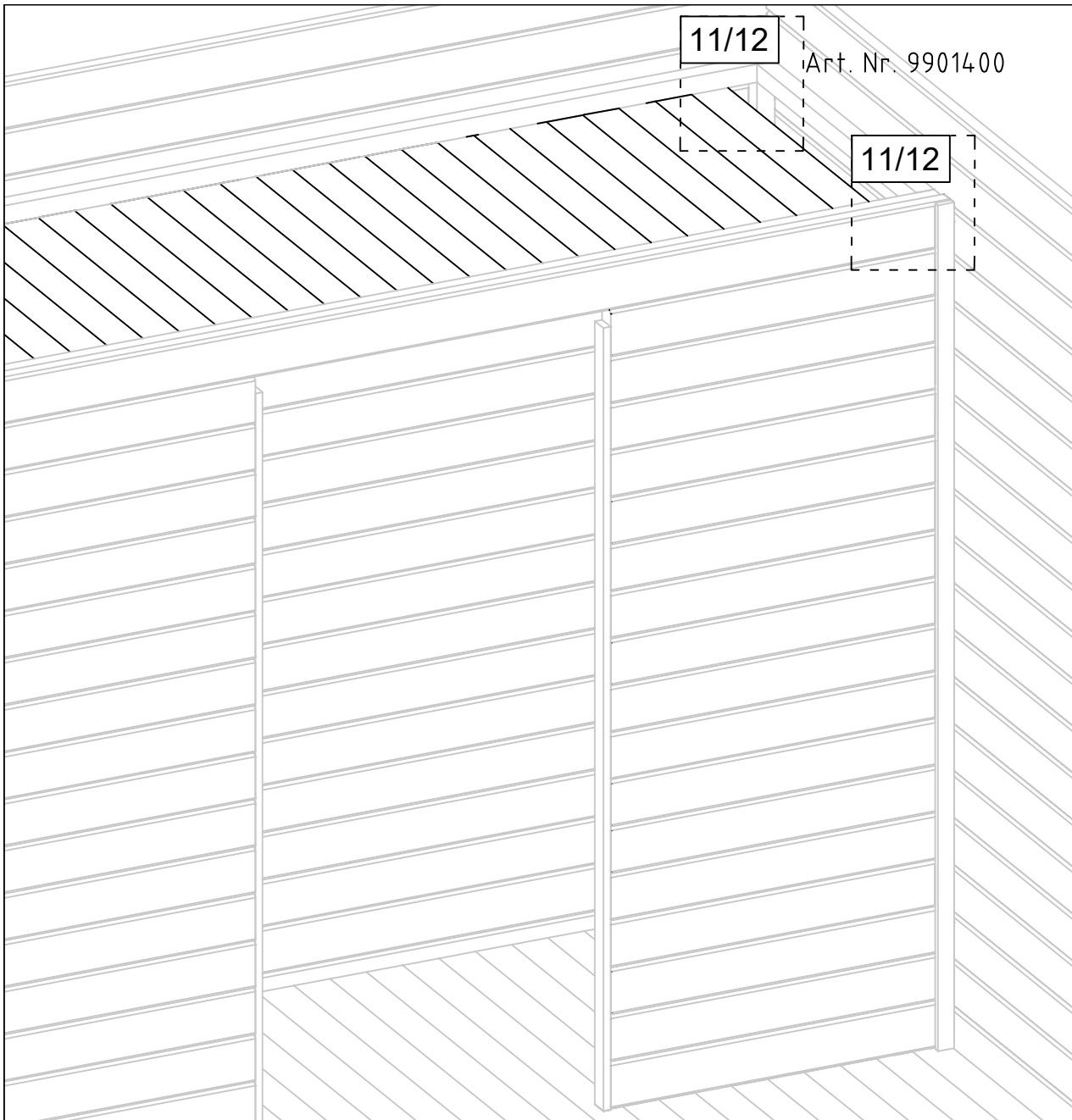







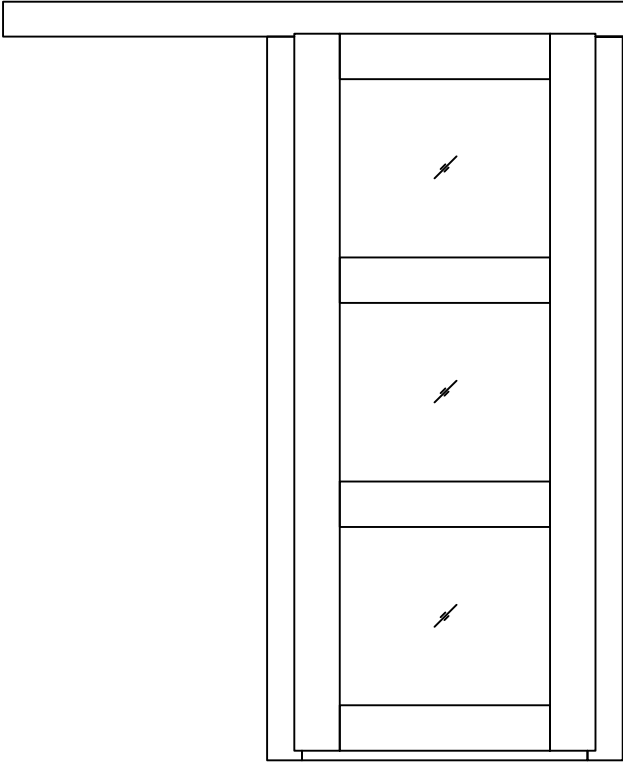
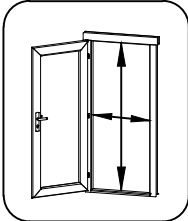
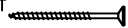

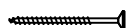
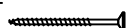

21.01.2020

Wind-tight chalet connection - Winddichte Chaletverbindung - Assemblage d'angle étanche au vent - Collegamento chalet antivento - Winddichte hoekverbinding - Tuuletapiga nurgäühendus

17/17

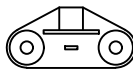
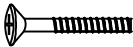
| Pos  | 14.01.2020 Piece list - Stückliste - Liste des pièces - Elementi - Stuklijst - Tükitalabel<br>835x1900 UK.3.030.TMLV.Mb MGP  | 1/1 | Q | P<br>(mm) | L<br>(mm) |
|------|--|-----|---|-----------|-----------|
|      |   <p>735x1868 mm</p>  |     |   |           |           |
| HS1  | Screw for rail - Schraube für schiene - Vis pour rail - Vite per binario - Schroef voor rails - Kruvi siinile   |     | 6 | 4x30      |           |
| HS8  | Screw for fixing sliding door - Schraube zur Befestigung der schiebetür - Vis de fixation porte coulissante - Vite per fissaggio porta scorrevole - Schroef voor bevestiging schuifdeur - Kruvi lükandukse montaažiks   |     | 9 | 3.5x35    |           |
| HS13 | Screw for fixing sliding door - Schraube zur Befestigung der schiebetür - Vis de fixation porte coulissante - Vite per fissaggio porta scorrevole - Schroef voor bevestiging schuifdeur - Kruvi lükandukse montaažiks   |     | 8 | 4x60      |           |
| HS16 | Screw for door jamb - Schraube für Türrahmen - Vis de fixation partie haute avec montants du cadre de porte - Viti x fissaggio montanti porte - Schroef voor deurkozijn - Kruvi ukse lengile    |     | 4 | 5x90      |           |
| HS16 | Screw for fixing door to the wall - Schraube zur Befestigung für - zarge mit wand - Vis de fixation partie basse dormants de porte au 1er rang de madrier - Viti per fissare la porta alla parete - Schroef voor bevestiging deur naar wand - Kruvi ukse lengi kinnitamiseks seinale  |     | 2 | 5x90      |           |
| TS4  | Rail - Schiene - Rail - Guida binaria - Rails - Lükandukse juhtsiin   |     | 1 | 28x31     | 1620      |
| HS5  | Screw for sliding door support plate - Schraube für Zubehör für Türblatt - Vis pour la plaque du support de la porte coulissante - Vite per piastra di supporto porta scorrevole - Schroef voor schuifdeur deurbeslag - Kruvi lükandukse kandeplaadile                                |     | 8 | 3.5x40    |           |
| HS7  | Screw for fixing sliding door - Schraube zur Befestigung der schiebetür - Vis de fixation porte coulissante - Vite per fissaggio porta scorrevole - Schroef voor bevestiging schuifdeur - Kruvi lükandukse montaažiks   |     | 4 | 3.5x25    |           |
| TS5  | Rail for door - Schiene für Türblatt, unten - Patin de guidage - Guida per porta - Deur rails - Lükandukse alumine juhik    |     | 1 | 4.5x65    |           |
| TS6  | Sliding door support plate - Zubehör für Türblatt - La plaque du support de porte coulissante - Piastra di supporto per porta scorrevole - Deur toebehoren - Lükandukse kandeplaat    |     | 2 | 3x30      |           |
| TS8  | Fixator for sliding door - Fixer für schiebetür - Boutee d'arrêt porte coulissante - Fissatore per porta scorrevole - Bevestiging voor schuifdeur - Lükandukse lahtihoiufiksaator   |     | 2 | 3.5x15    |           |
| TS11 | Roller for sliding door - Laufrad für schiebetür - Ferrure pour porte coulissante - Rullo per porta scorrevole - Wielkatrol voor schuifdeur - Lükandukse vanker   |     | 2 | 3.5x35    |           |
| TS12 | Bolt for sliding door roller - Bolzen für schiebetür laufrad - Boulon pour roller de porte coulissante - Bullone per rullo porta scorrevole - Schuifdeur bout - Lükandukse vankri ja kandeplaadi ühenduspolt    |     | 2 | 3.5x35    |           |

