

White Nile
Art.No. 702941

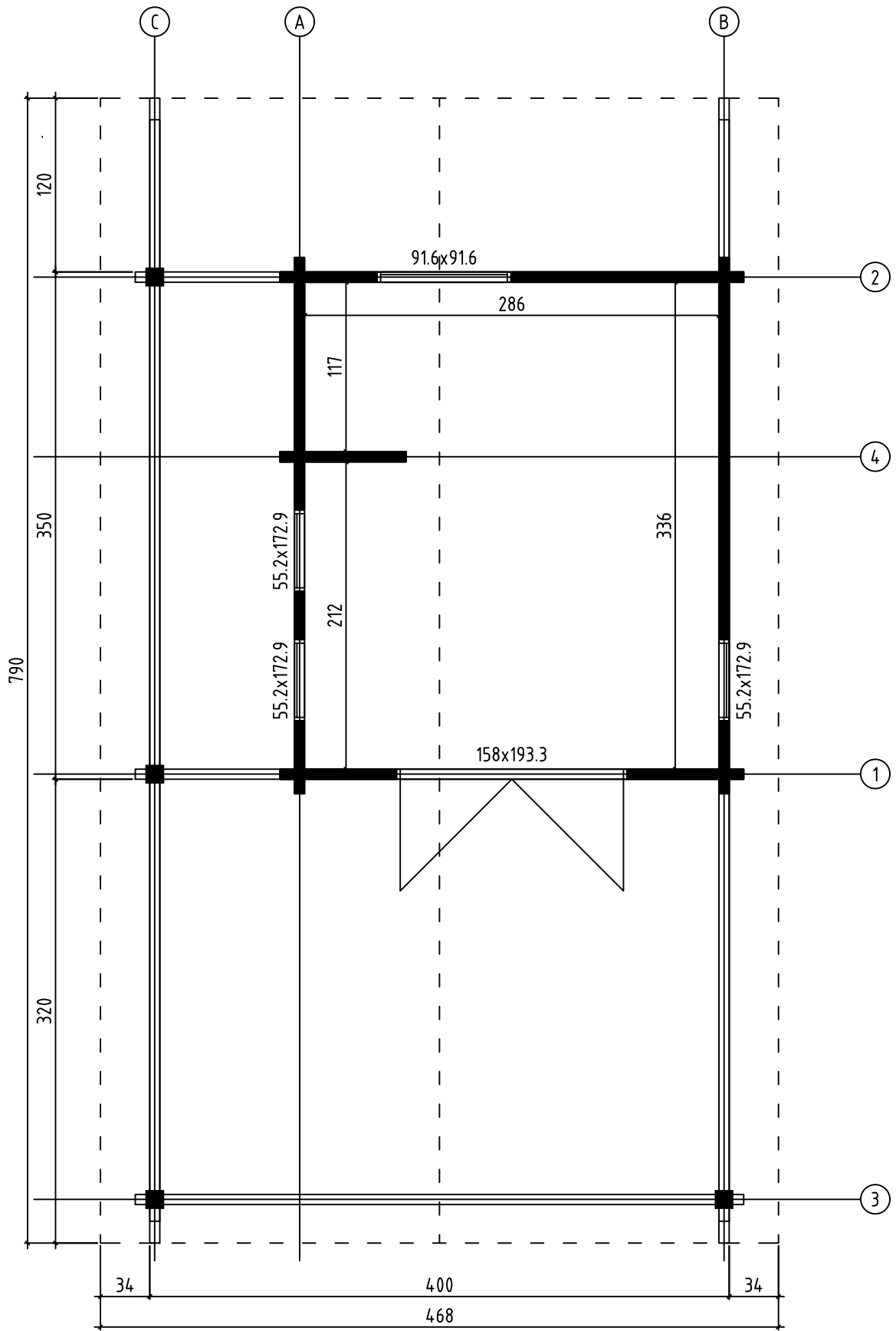

White Nile, Art.No. 702941
GROUNDPLAN - GRUNDPLAN - PLAN DE MASSE



White Nile, Art.No. 702941
 FOUNDATION - FUNDAMENT - FONDATION

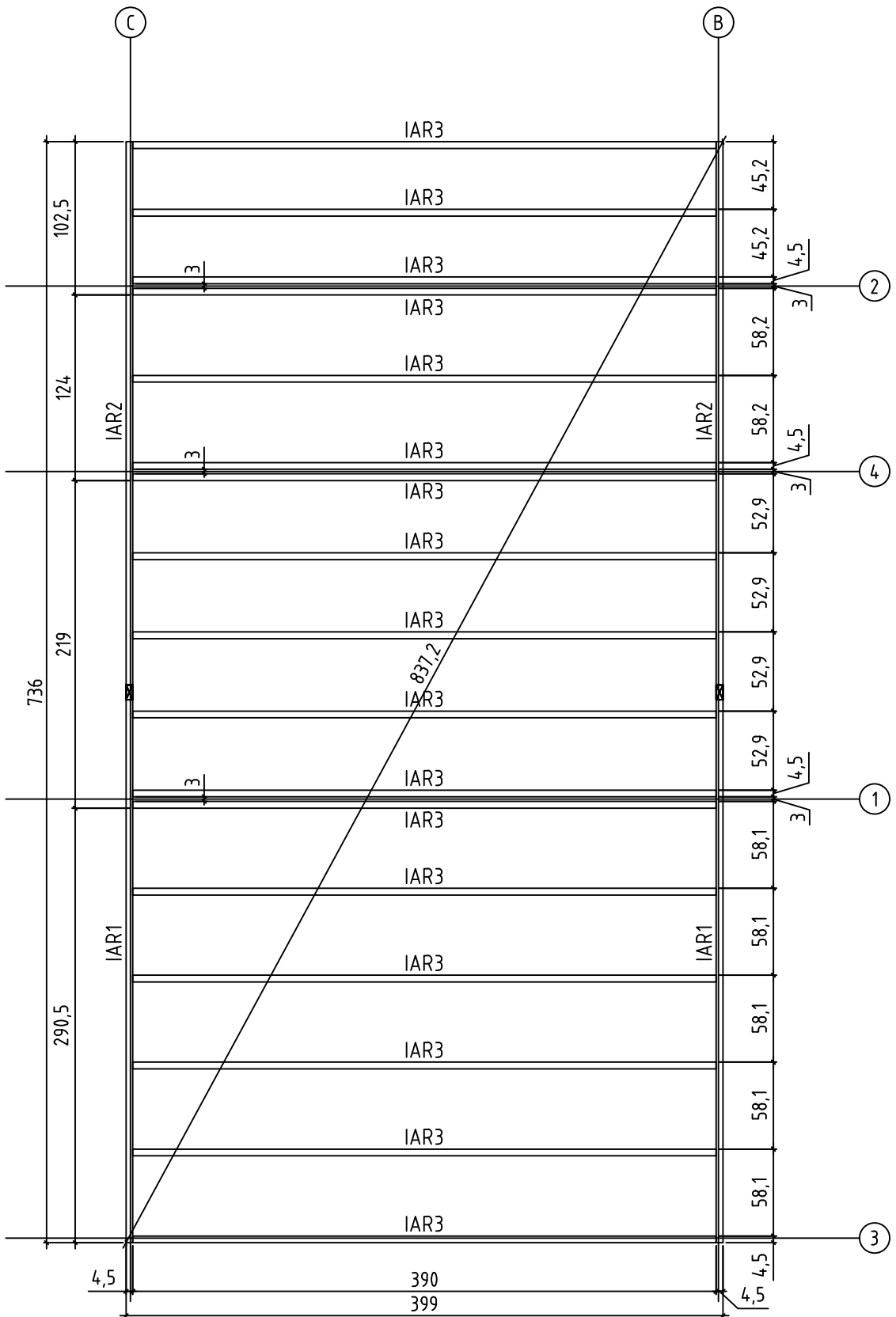

White Nile, Art.No. 702941
FLOOR BOARDS - FUSSBODENBRETTER - PLAN POSE PLANCHER

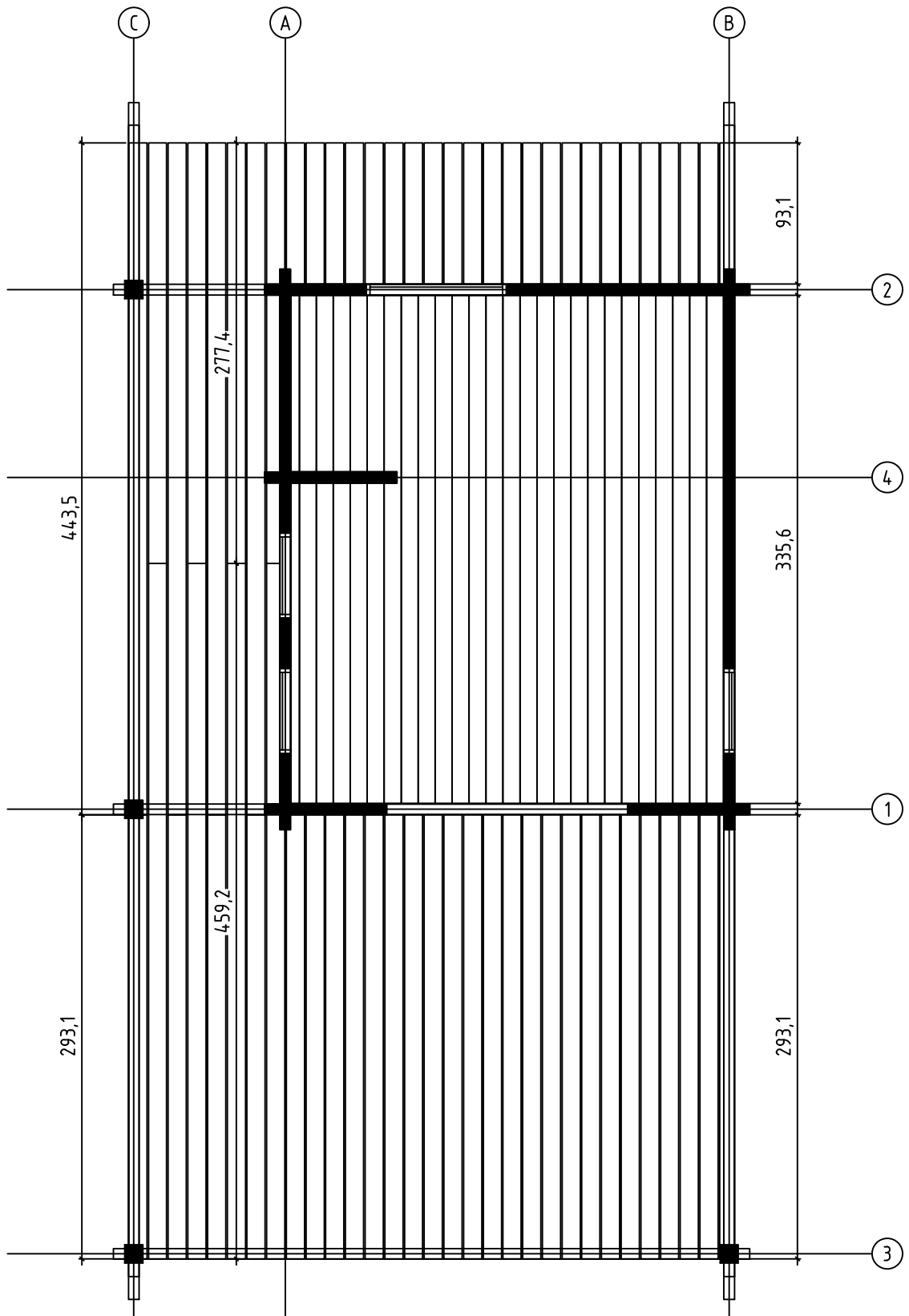

White Nile, Art.No. 702941

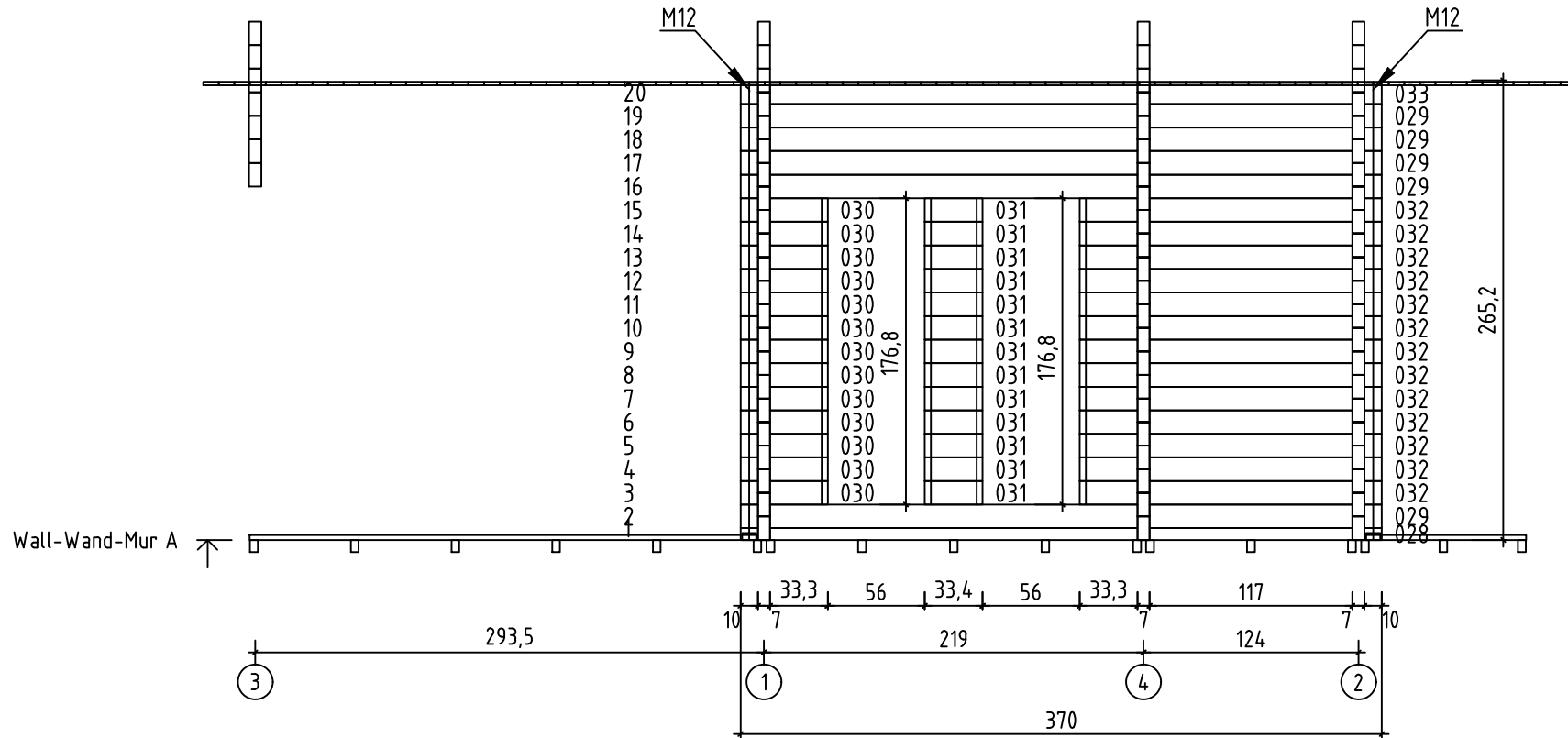

White Nile, Art.No. 702941

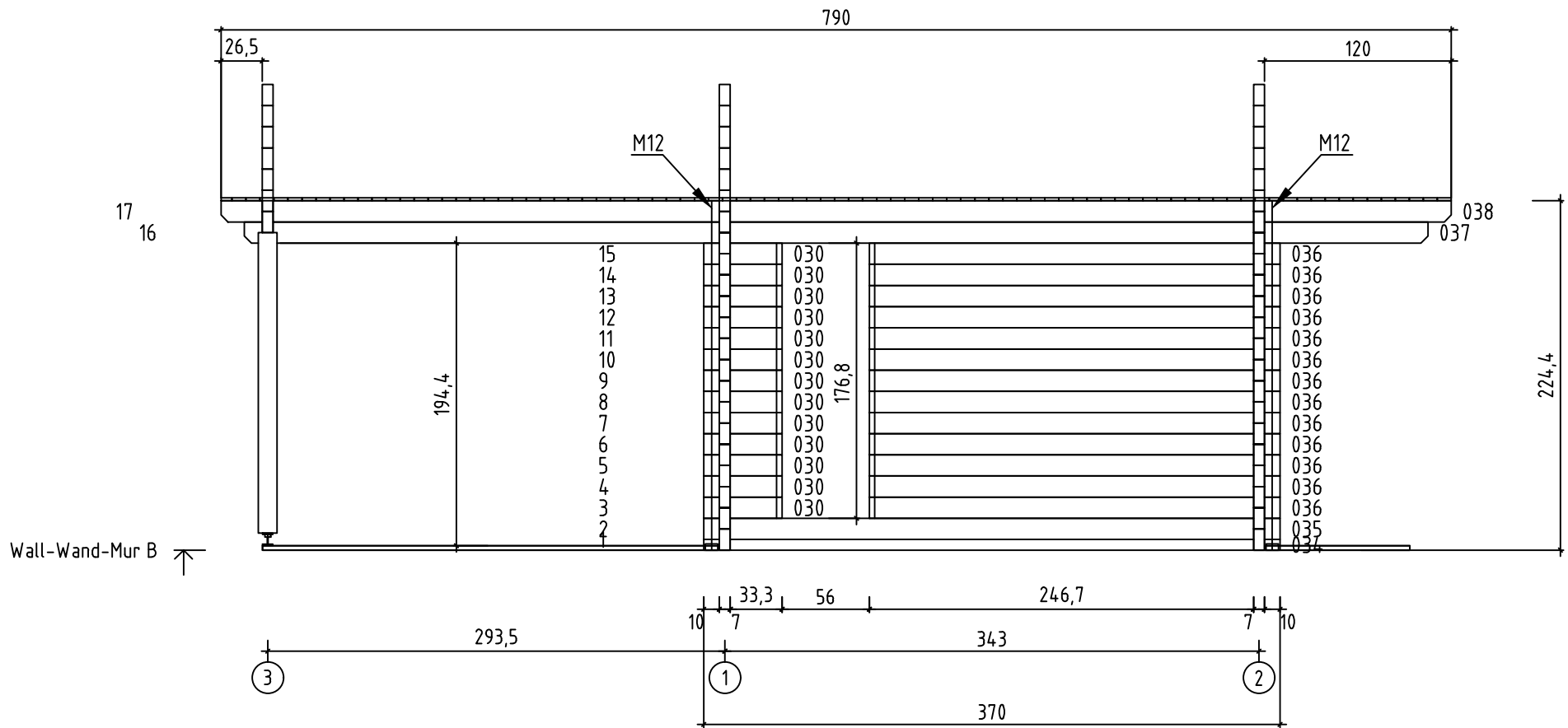

White Nile, Art.No. 702941

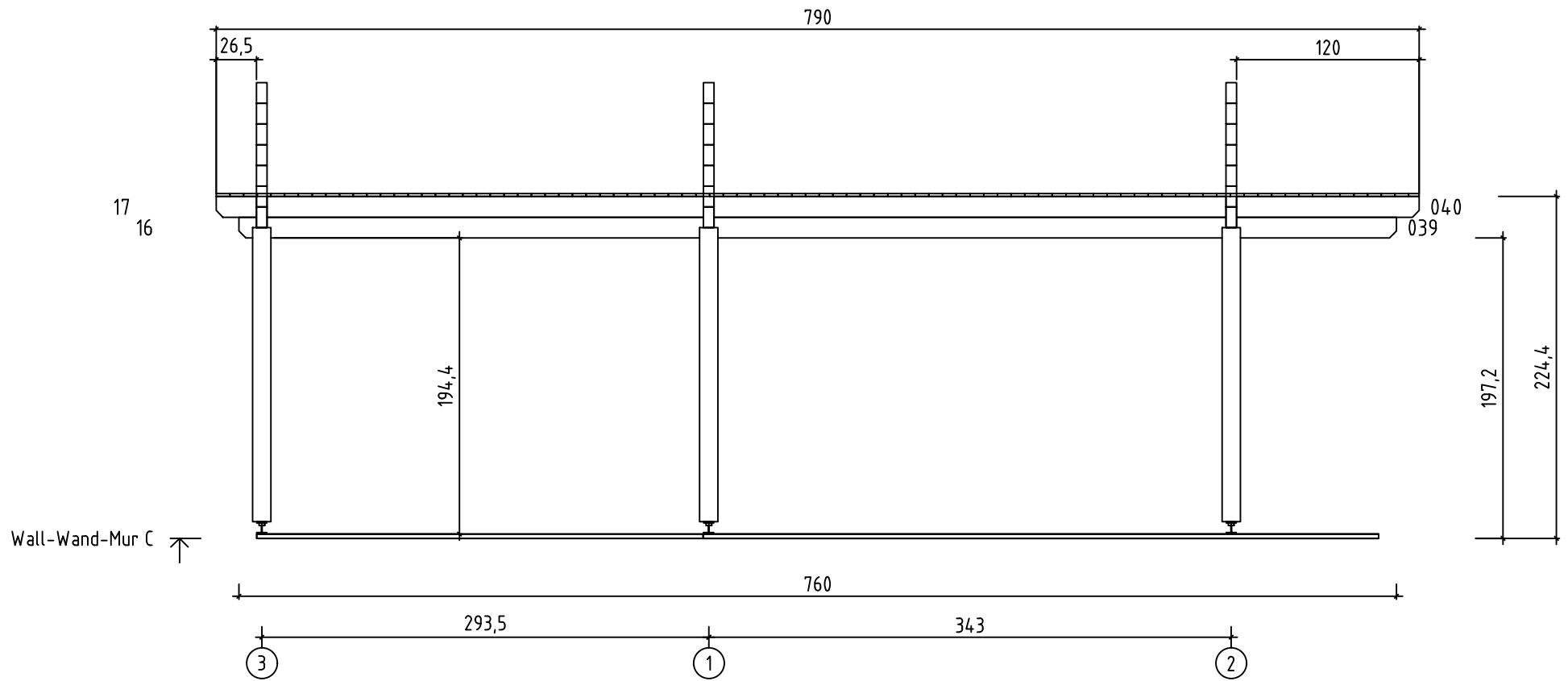

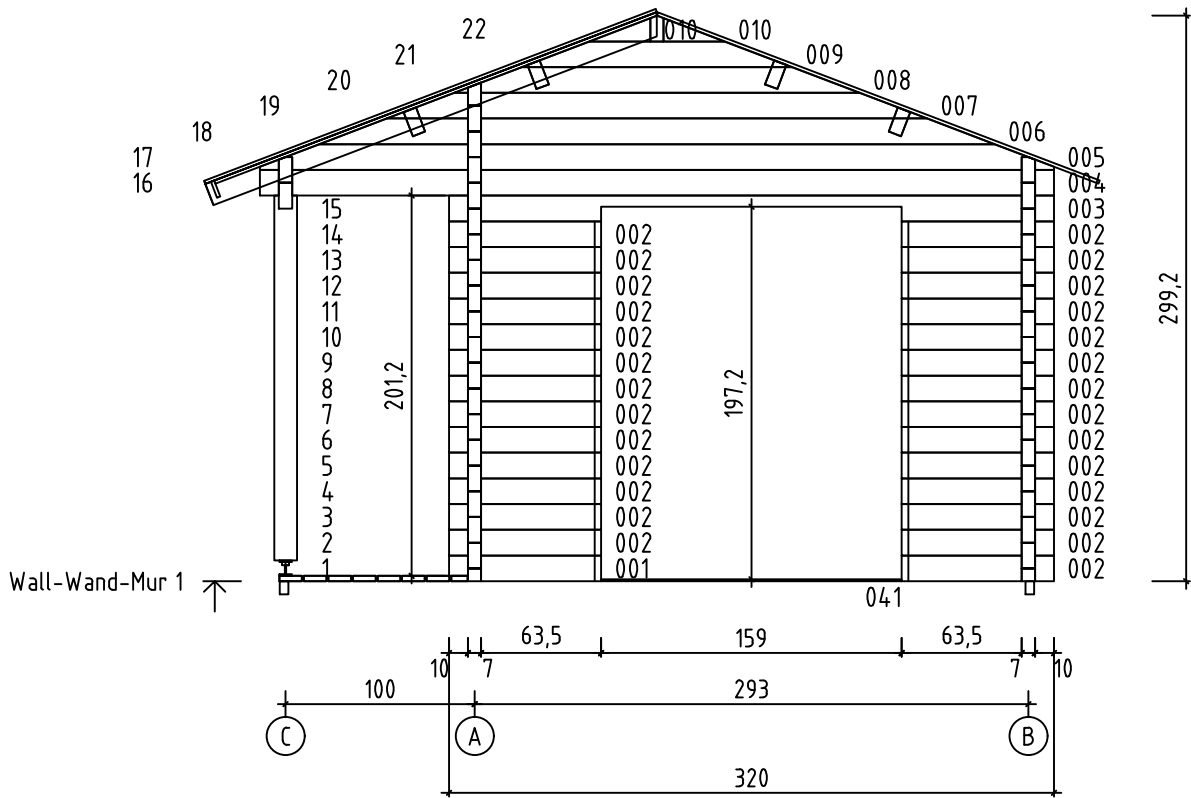

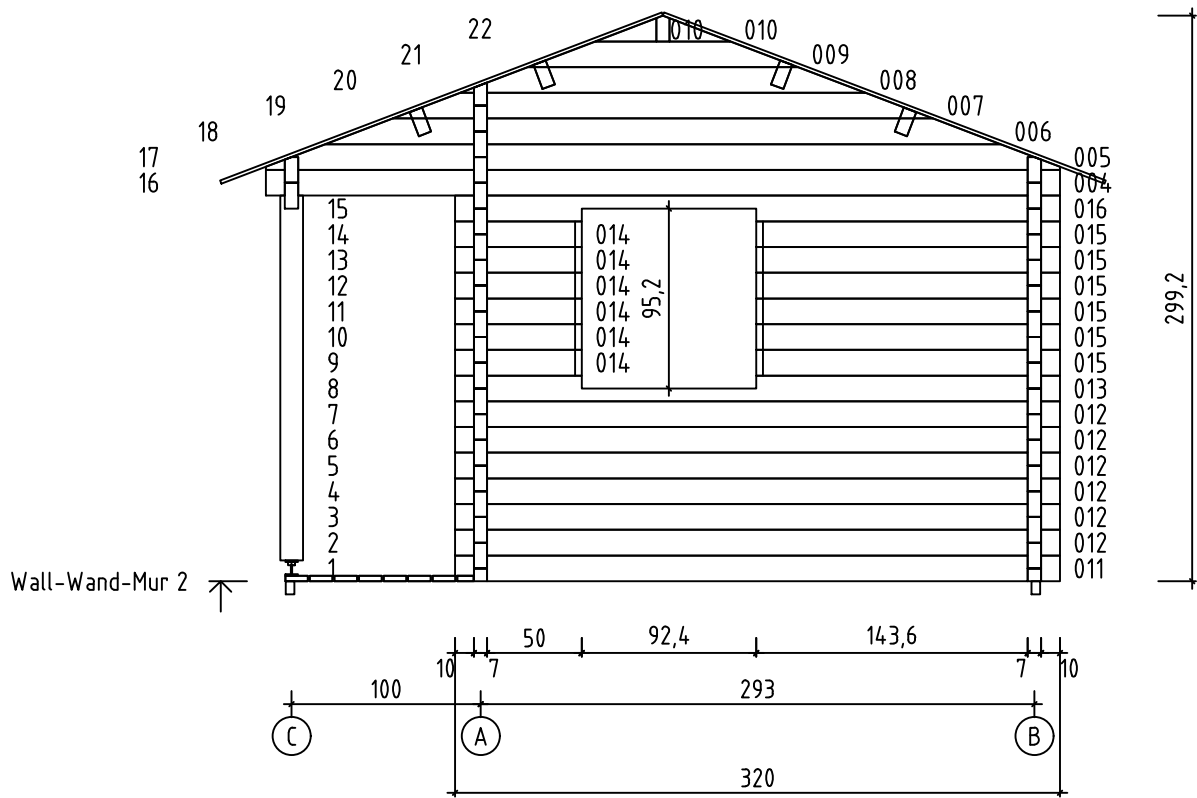

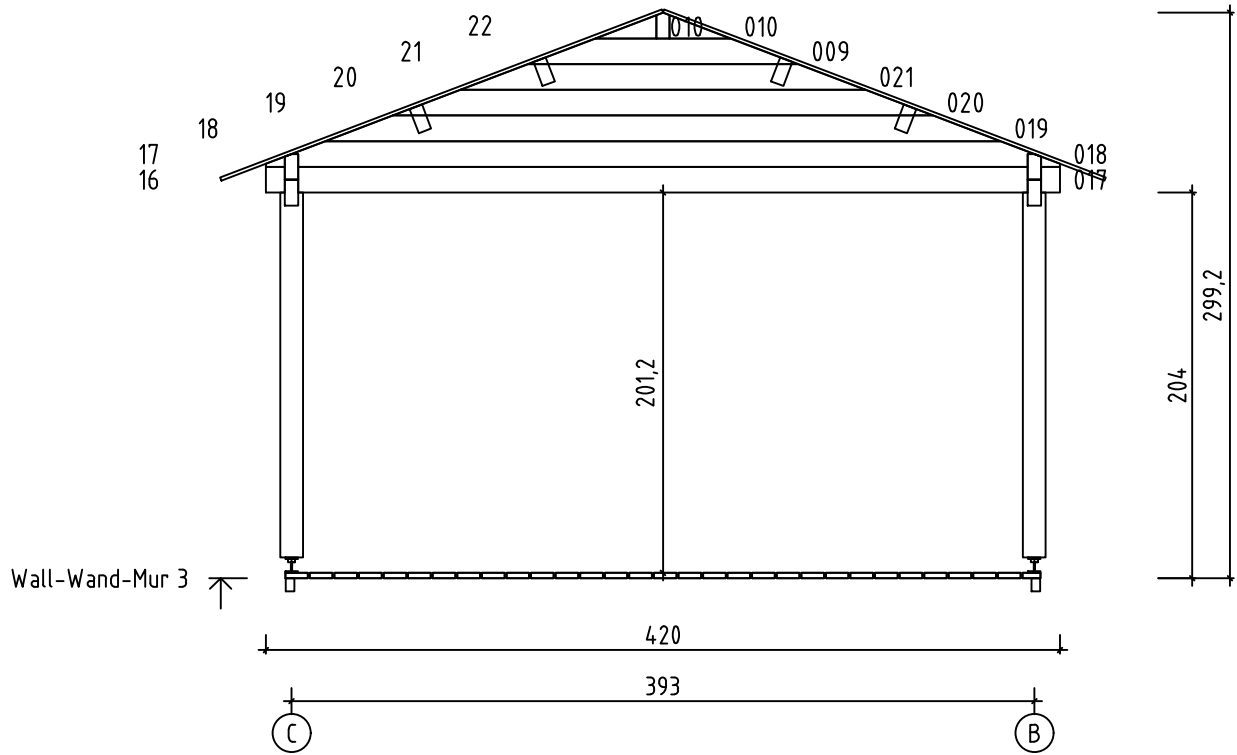

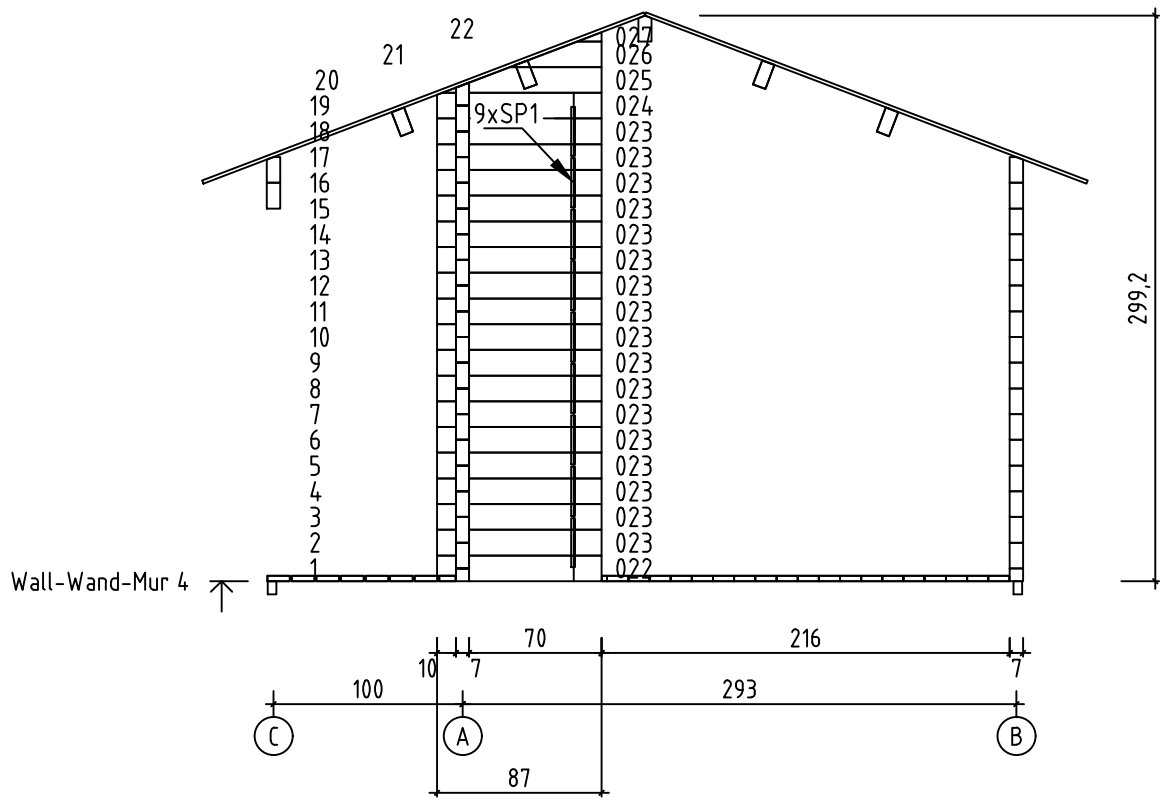



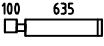
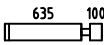
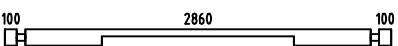
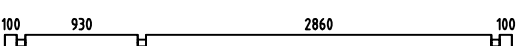
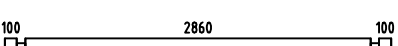
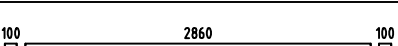
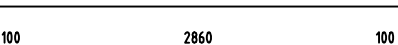

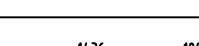
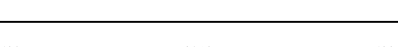
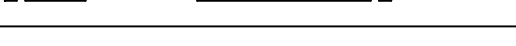
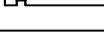
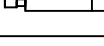
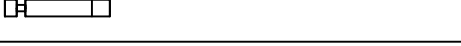
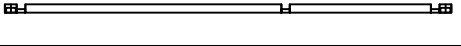



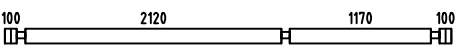
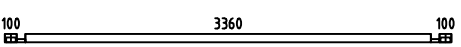

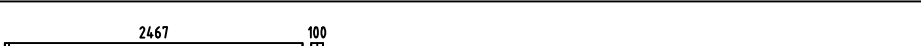
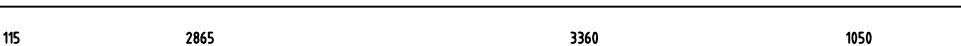
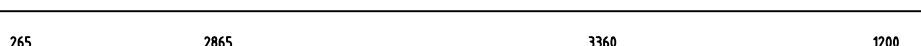

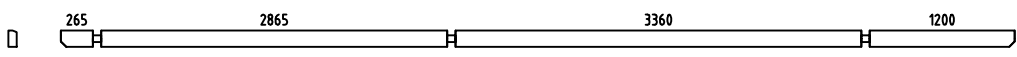

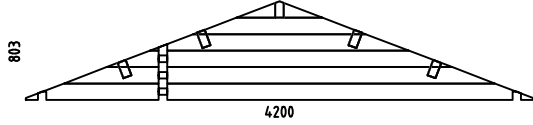
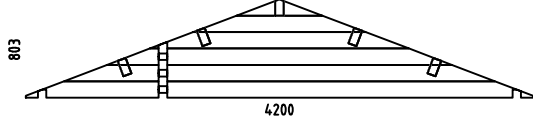
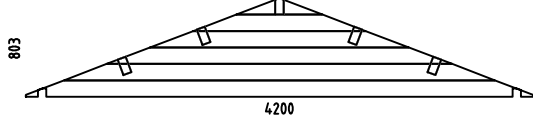
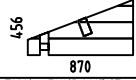
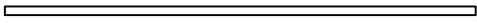
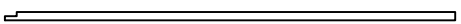
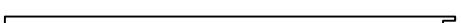
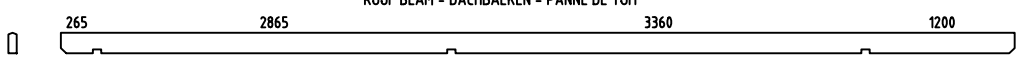
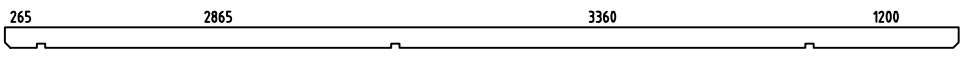
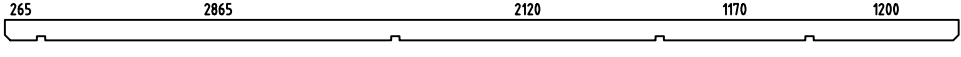







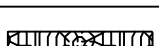















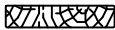



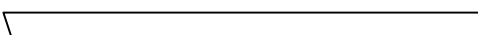

















White Nile, Art.No. 702941
 Piece list - Stückliste - Liste des pieces

Pos		Q.	P (mm)	L (mm)
001		1	70x136	805
002		27	70x136	805
003		1	70x136	3200
004		2	70x136	4200
011		1	70x136	3200
012		6	70x136	3200
013		1	70x136	3200
014		6	70x136	670
015		6	70x136	1606
016		1	70x136	3200
017		1	70x136	4200
022		1	70x136	870
023		17	70x136	870
028		1	70x68	3700
029		5	70x136	3700
030		26	70x136	503
031		13	70x136	334
032		13	70x136	1743
033		1	70x122	3700
034		1	70x68	3700
035		1	70x136	3700
036		13	70x136	2637
037		1	70x136	7600
038		1	70x136	7900
039		1	70x136	7600

Pos	White Nile, Art.No. 702941 Piece list - Stückliste - Liste des pieces	Q.	P (mm)	L (mm)
040		1	70x136	7900
041		1	70x10	1590
W1-1		1		
W2-1		1		
W3-1		1		
W4-1		1		
IAR3	FOUNDATION - FUNDAMENT - FONDATION 	17	45x70	3900
IAR2	FOUNDATION - FUNDAMENT - FONDATION 	2	45x70	3730
IAR1	FOUNDATION - FUNDAMENT - FONDATION 	2	45x70	3730
PR1	ROOF BEAM - DACHBALKEN - PANNE DE TOIT 	1	70x170	7900
A-PR1	ROOF BEAM - DACHBALKEN - PANNE DE TOIT 	3	70x170	7900
A-PR2	ROOF BEAM - DACHBALKEN - PANNE DE TOIT 	1	70x170	7900
PTL	FLOOR BOARDS - FUSSBODENBRETTER - LAME DE PLANCHER 	20	112x28	3356
PTL	FLOOR BOARDS - FUSSBODENBRETTER - LAME DE PLANCHER 	6	112x28	2116
PTL	FLOOR BOARDS - FUSSBODENBRETTER - LAME DE PLANCHER 	6	112x28	1166
	ROOF BOARDS - DACHBRETTER - VOLIGES 	176	90x18	2500
SV2	TERRACE BOARDS - TERRASSENBRETTER - PLANCHER DE TERRASSE 	4	120x28	4592
SV2	TERRACE BOARDS - TERRASSENBRETTER - PLANCHER DE TERRASSE 	4	120x28	4435
SV2	TERRACE BOARDS - TERRASSENBRETTER - PLANCHER DE TERRASSE 	27	120x28	2931
SV2	TERRACE BOARDS - TERRASSENBRETTER - PLANCHER DE TERRASSE 	4	120x28	2774
SV2	TERRACE BOARDS - TERRASSENBRETTER - PLANCHER DE TERRASSE 	23	120x28	931
	FLOOR FILLET-FUSSBODENLEISTE - CORNIERE DE FINITION DU PLANCHER 		15x40	13.8 m.

Pos	White Nile, Art.No. 702941 Piece list - Stückliste - Liste des pieces	Q.	P (mm)	L (mm)
DPL	ROOFING FELT FILLET - DACHPAPPENLEISTE - BAGUETTE DE FIXATION DU FEUTRE BITUMEUX 	4	18x58	2550
M12	TREADED ROD M12 - GEWINDESTANGE M12 - TIGE FILETÉE M12 	2		235
M12	TREADED ROD M12 - GEWINDESTANGE M12 - TIGE FILETÉE M12 	2		630
M12	TREADED ROD M12 - GEWINDESTANGE M12 TIGE FILETÉE M12 	4		2000
LPL	FIXING FILLET - FIXIRUNGSLEISTE - PROFIL DE FIXATION 	6	20x70	512
LPL	FIXING FILLET - FIXIRUNGSLEISTE - PROFIL DE FIXATION 	2	20x70	876
LPL	FIXING FILLET - FIXIRUNGSLEISTE - PROFIL DE FIXATION 	2	20x70	916
LPL	FIXING FILLET - FIXIRUNGSLEISTE - PROFIL DE FIXATION 	1	20x70	1540
LPL	FIXING FILLET - FIXIRUNGSLEISTE - PROFIL DE FIXATION 	6	20x70	1729
LPL	FIXING FILLET - FIXIRUNGSLEISTE - PROFIL DE FIXATION 	2	20x70	1933
P	POST - PFOSTEN - POTEAU 	4	120x120	1930
TB	EAVES BOARD - TRAUFBRETT - BANDEAU DE TOIT 	4	18x90	3950
DRV	ROOF EDGE REINFORCEMENT - DACHRANDVERSTÄRKUNG - CORNIERE DE RENFORT DE BORD DE TOIT 	4	28x34	3950
TBE6	FIXING FILLET FOR WINDOW - FIXIRUNGSLEISTE FÜR FENSTER - PROFIL DE FIXATION DES FENETRES 	2	28x34	748
TBE6	FIXING FILLET FOR WINDOW - FIXIRUNGSLEISTE FÜR FENSTER - PROFIL DE FIXATION DES FENETRES 	6	28x34	1729
TBE6	FIXING FILLET FOR DOOR - FIXIRUNGSLEISTE FÜR TÜR - PROFIL DE FIXATION DES PORTES 	2	28x34	1826
GL	GABLE MOULDING - GIEBELLEISTE PLANCHE DE RIVE 	4	18x120	2550
KL4	LENGTHENING BOLT FOR TREADED ROD - VERLÄNGERUNGSMUTTER FÜR GEWINDESTANGE - MANCHON DE RACCORDEMENT DE TIGE FILETÉE 	4		
KL1	DRIVE NUT TREADED ROD - EINSHLAGMUTTER FÜR GEWINDESTANGE - ÉCROU A FRAPPER POUR TIGE FILETÉE 	4		
KL2	NUT FOR TREADED ROD - MUTTER FÜR GEWINDESTANGE - ÉCROU POUR TIGE FILETÉE 	4		
KL3	PLAIN WASHER TREADED ROD - UNTERLEGSSCHEIBE FÜR GEWINDESTANGE - RONDELLE PLATE POUR TIGE FILETÉE 	4		
HS12	SCREW FOR GABLE SEGMENT - SCHRAUBEN FÜR DECKBLATT - VIS POUR FIXATION LOSANGE DE FINITION 	4	3.5x35	
HS83	SCREW FOR FIXING FILLET - SCHRAUBEN FÜR FIXIRUNGSLEISTE - VIS POUR PROFIL DE FIXATION 	85	3.5x50	
HS84	SCREW FOR FIXING FILLET - SCHRAUBEN FÜR FIXIRUNGSLEISTE - VIS POUR PROFIL DE FIXATION 	48	3.5x50	
HS16	SCREW FOR GABLE MOULDING - SCHRAUBEN FÜR GIEBELLEISTE - VIS DE FIXATION POUR PLANCHE DE RIVE 	32	3.5x50	

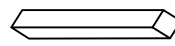
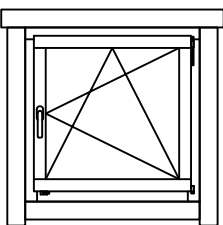
Pos	White Nile, Art.No. 702941 Piece list - Stückliste - Liste des pieces		Q.	P (mm)	L (mm)
HS32	SCREW FOR EAVES BOARDS - SCHRAUBEN FÜR TRAUFBRETTTER - VIS DE FIXATION POUR BANDEAU DE TOIT		36	4x40	
HS26	SCREW FOR ROOF EDGE REINFORCEMENT - SCHRAUBEN FÜR DACHRANDVERSTÄRKUNG - VIS POUR RENFORT DE BORD DE TOIT		36	4x40	
HS34	SCREW FOR POST - SCHRAUBEN FÜR PFOSTEN - VIS DE FIXATION DES POTEAUX		8	4x60	
HS40	SCREW FOR 1. WALL BEAM - SCHRAUBE FÜR 1. BOHLENREIHE - VIS DE FIXATION DES FONDATIONS		8	5x120	
HS42	SCREW FOR GABLE - SCHRAUBEN FÜR GIEBEL - VIS POUR FIXATION DES PIGNONS		17	5x120	
HS43	SCREW FOR ROOF BEAMS - SCHRAUBEN FÜR DACHBALKEN - VIS POUR PANNE DE TOIT		14	5x120	
HS39	SCREW FOR FUNDAMENT - SCHRAUBEN ZUR BEFESTIGUNG FUNDAMENT - VIS POUR FONDATION		42	5x90	
HS49	SCREW FOR POST HEIGHT ADJUSTMENT - SCHRAUBEN FÜR REGULIERUNGSSCHRAUBE FÜR PFOSTEN - VIS DE FIXATION DE SUPPORT RÉGLABLE DE POTEAU		32	6x50	
MS	SCREW FOR DOORSTEP - SCHRAUBEN FÜR TÜRSCHWELLE - VIS DE FIXATION DU SEUIL DE PORTE		3	4.5x65	
SH70	HAMMER BLOCK - SCHLAGHOLZ - CALLE DE FRAPPE		1		
NFD	ZN NAIL FOR ROOFING FELT FILLET - ZN NÄGEL FÜR DACHPAPPENLEISTE - POINTE POUR BAGUETTE FIXATION FEUTRE BITUMEUX		24	2x40	
NF3	ZN NAIL FOR TERRACE - ZN NÄGEL FÜR TERRASSENBRETTTER - POINTE POUR PLANCHER DE TERRASSE		720	2x50	
NFF	ZN NAIL FOR FLOOR FILLETS - ZN NÄGEL FÜR FUSSBODENLEISTEN - POINTE POUR PANNEAUX DE PLANCHER		28	1.4x40	
NF2	ZN NAIL FOR ROOF - ZN NÄGEL FÜR DACHBRETTTER - POINTE POUR TOIT		740	2x50	
NH1	ZN NAIL FOR FLOOR - ZN NÄGEL FÜR FUSSBODENBRETTTER - CLOUS POUR PLANCHER		220	2x50	
ORZ	MONTAGE SET FOR DOORS AND WINDOWS - MONTAGE-SET FÜR TÜREN UND FENSTER - JEU DE MONTAGE PORTES ET FENETRES		1		
GS	GABLE SEGMENT-DECKBLATT - LOSANGE DE FINITION		2		
SP1	HIDDEN FIXING - HOLZDÜBEL - TOURILLON BOIS		9		
RFP	POST HEIGHT ADJUSTMENT - REGULIERUNGSSCHRAUBE FÜR PFOSTEN - SUPPORT RÉGLABLE DE POTEAU		4		
2+ A.OP	WINDOW-FENSTER-FENETRE 916x916 		1		

