

# Technische Daten



Spiegelverkehrte Montage möglich.

## Artikelnummer:

350 160

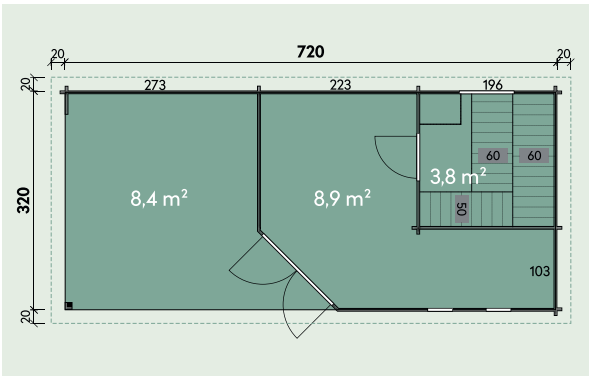

Kontrolliert durch:

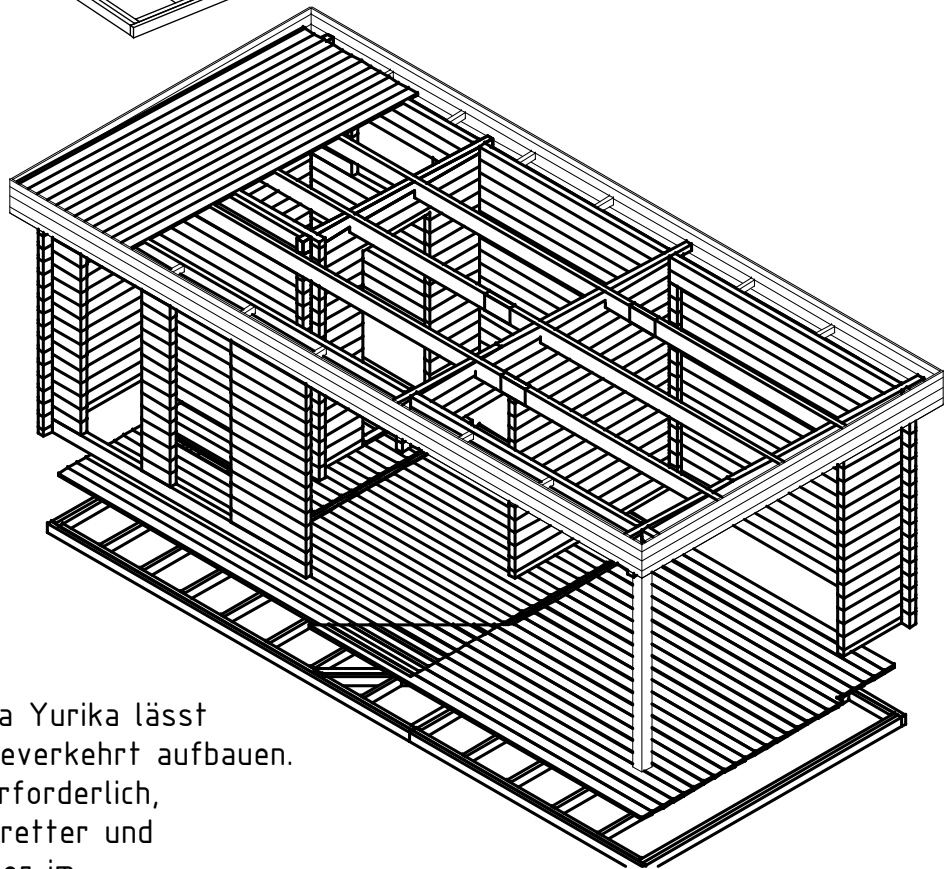
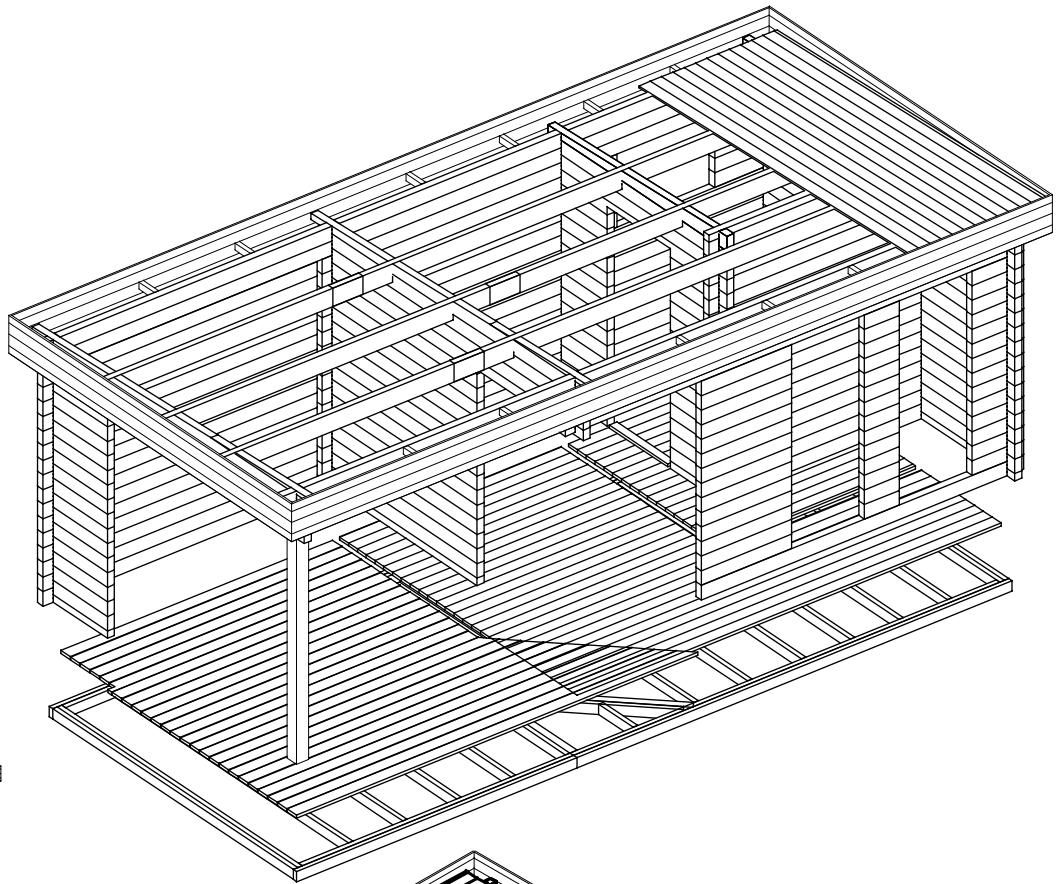

Das Haus Sauna Yurika lässt sich auch spiegeverkehrt aufbauen. Darum ist es erforderlich, die Fussbodenbretter und Terrassenbretter im Eingangsbereich laut beigefügter Zeichnung selbst zuzuschneiden.

**Saunahaus Aufbau mit Terrasse links**

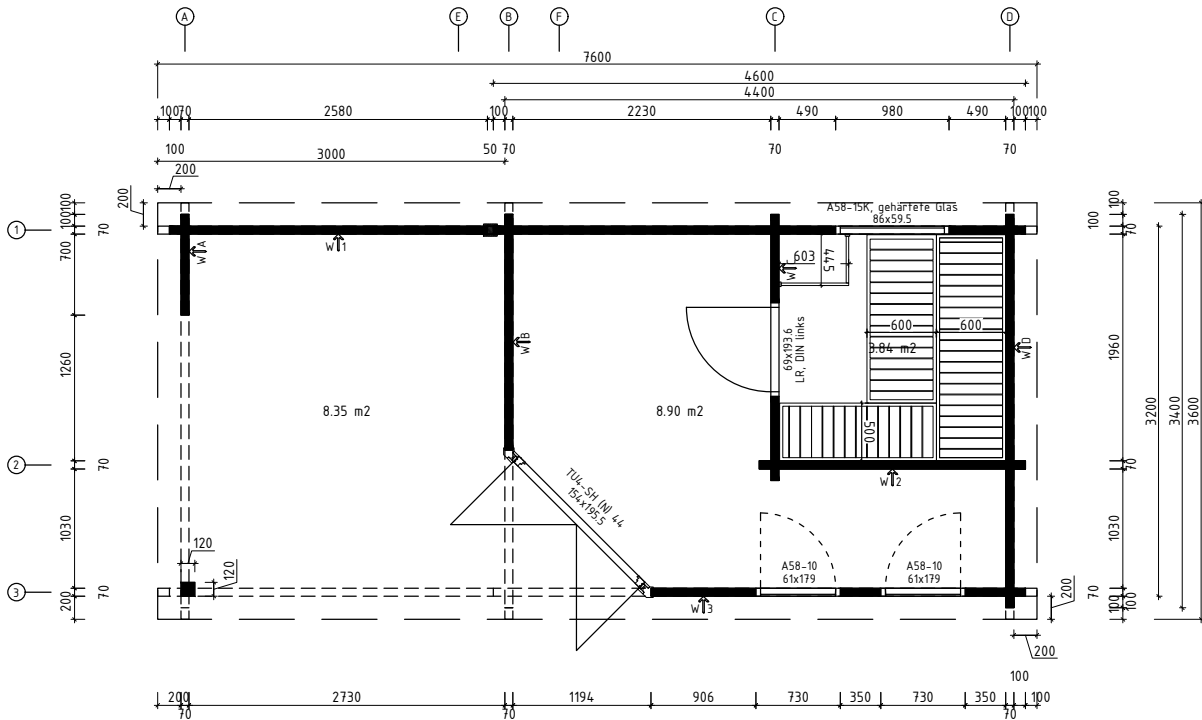

\* Fenster und Türen sind ohne Sprossen  
**Q4** – Qualitätsklasse für Fenster und Türen

**Saunahaus Aufbau mit Terrasse rechts**

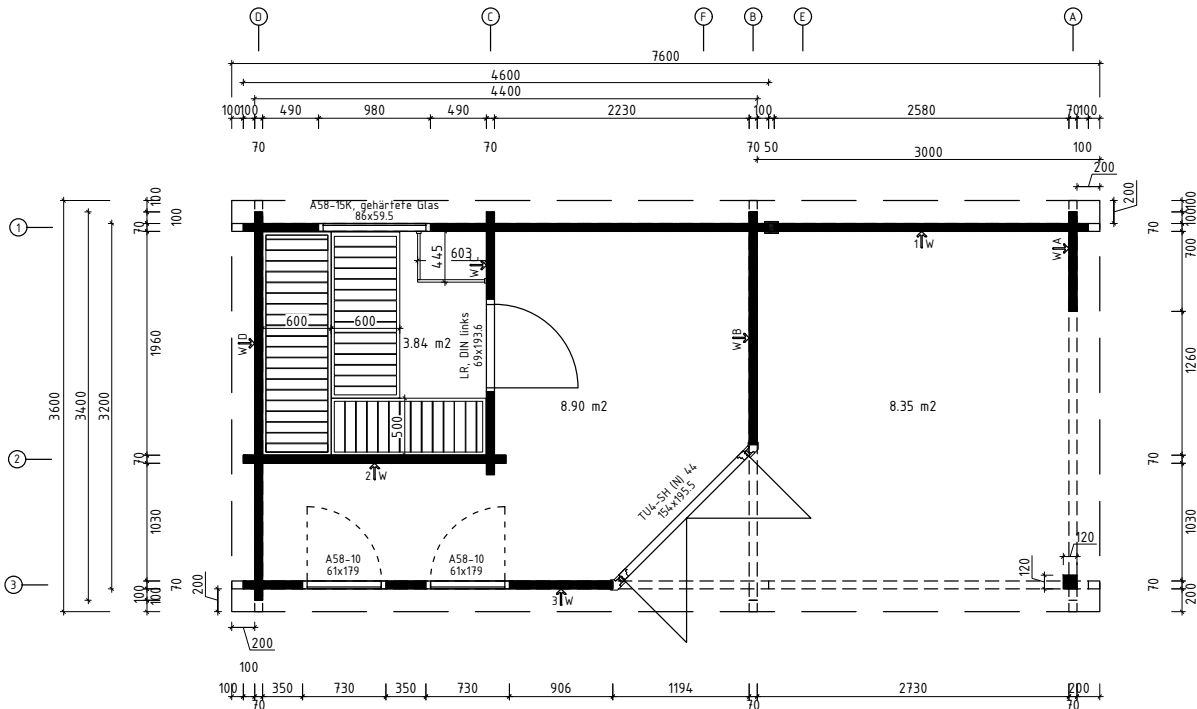

\* Fenster und Türen sind ohne Sprossen  
**Q4** – Qualitätsklasse für Fenster und Türen

**Wir empfehlen als Fundament für Ihr Gartenhaus eine vollflächig festgegründete, gepflasterte oder betonierte Fläche. Wahlweise ist auch ein Punkt- oder Streifenfundament möglich.**

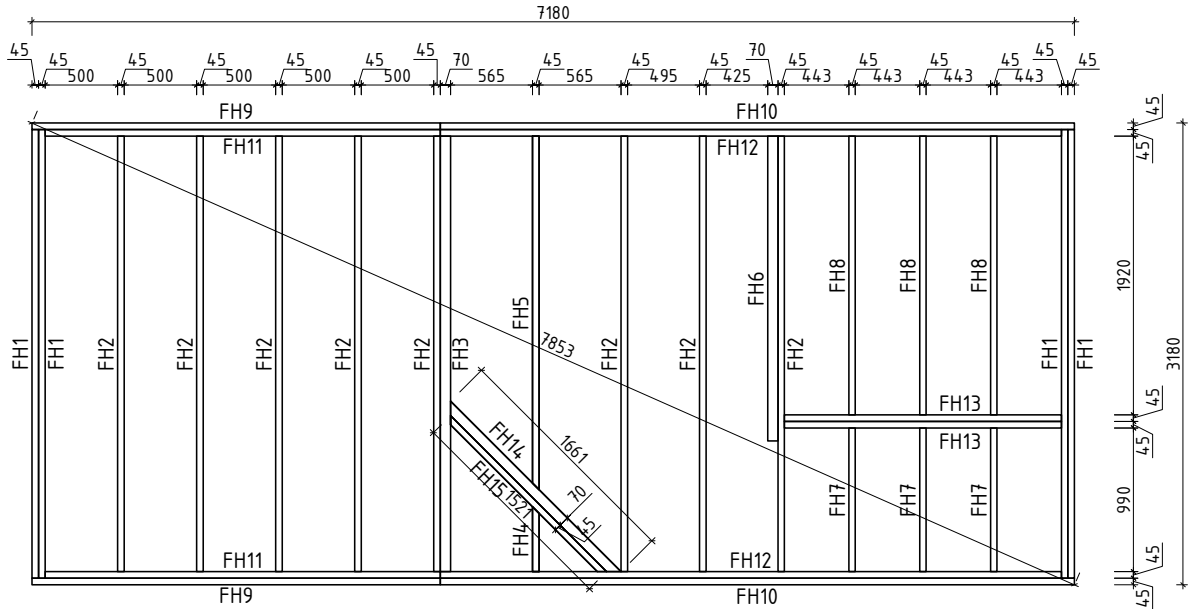



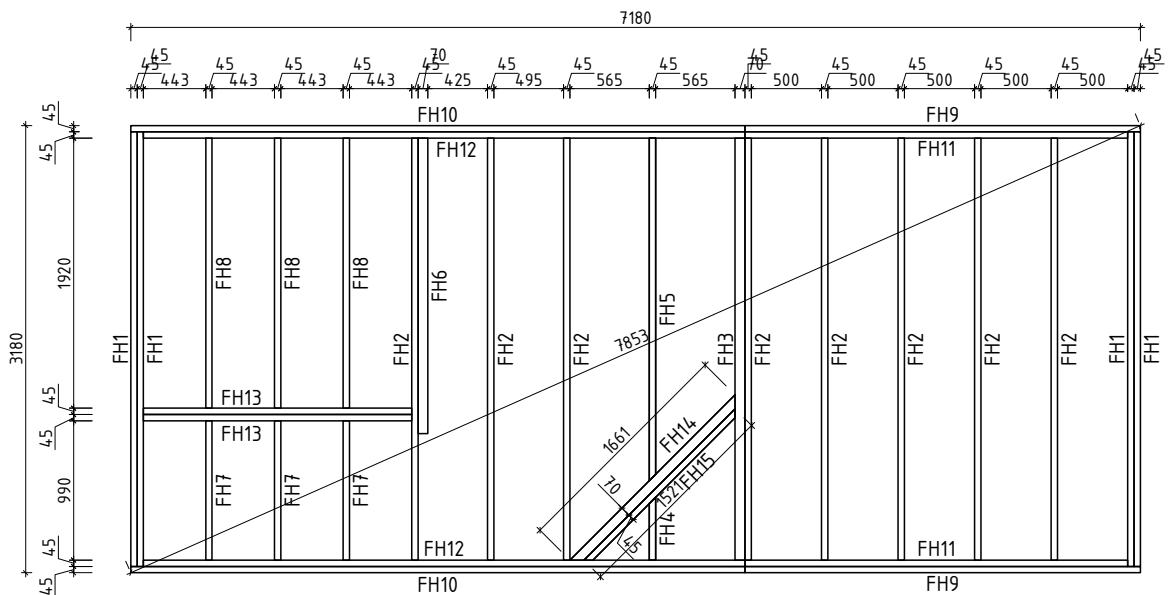



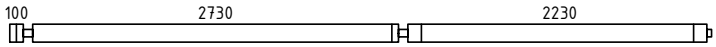
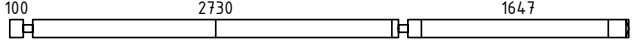
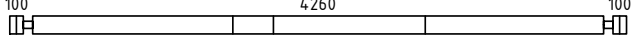
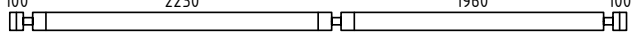
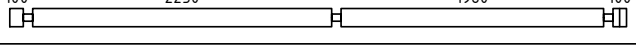
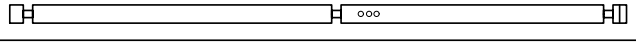
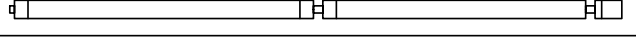
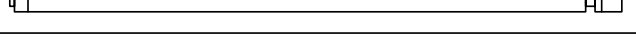
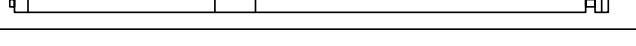
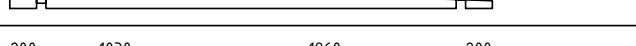
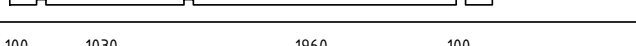
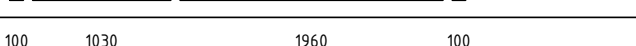
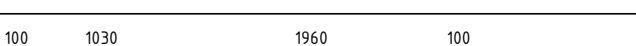
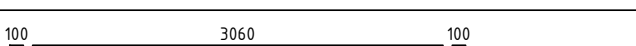
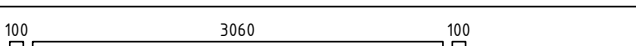
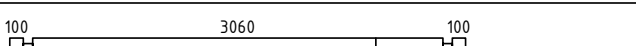
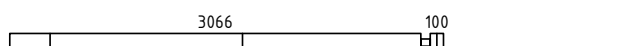
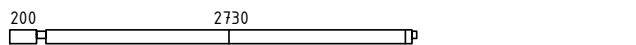
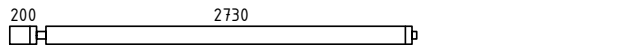
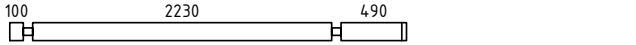
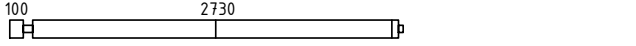
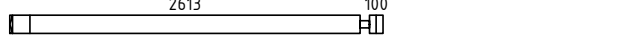
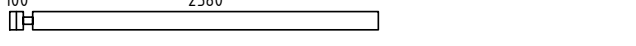
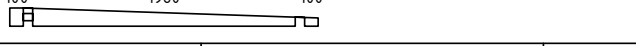
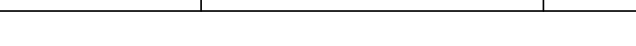



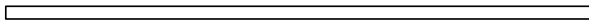
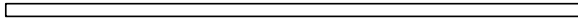
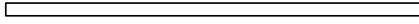
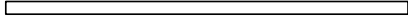
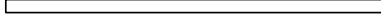

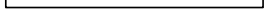
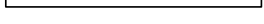

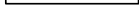
**Fundamentplan für Aufbau Terrasse links**



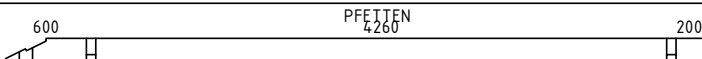
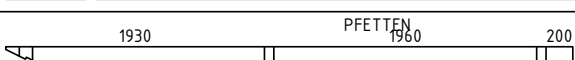
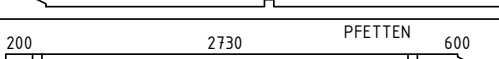
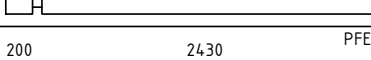
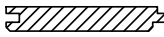

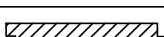

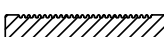



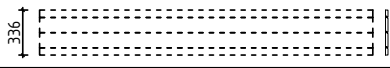
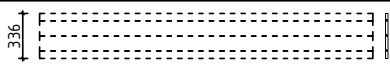
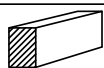
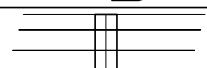





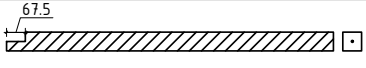

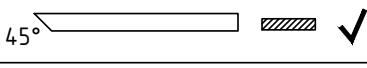

**Fundamentplan für Aufbau Terrasse rechts**



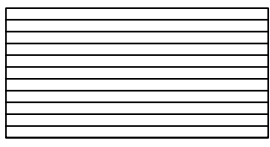

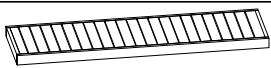
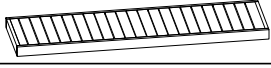
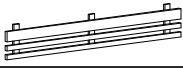





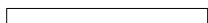

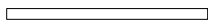

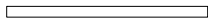

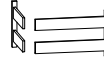



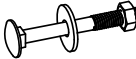

Pos		Stck	Profil (mm)	Länge (mm)
001		1	70x135	5235
002		1	70x135	4617
003		1	70x135	4600
004		1	70x135	4600
005		9	70x135	4600
006		1	70x135	4600
007		1	70x135	4565
008		1	70x104	4565
009		1	70x135	4465
010		2	70x135	3600
011		1	70x135	3600
012		15	70x135	3400
013		2	70x135	3400
014		1	70x68	3400
015		1	70x135	3400
016		3	70x135	3400
017		1	70x135	3400
018		1	70x135	3236
019		1	70x104	3035
020		1	70x135	3035
021		5	70x135	2960
022		1	70x135	2935
023		1	70x135	2783
024		16	70x135	2750
025		1	70x135	2300

Pos		Stck	Profil (mm)	Länge (mm)
026		1	70x68	2300
027		20	70x135	2300
028		1	70x135	2300
029		1	70x135	2165
030		14	70x135	2036
031		1	70x68	2036
032		3	70x43	1300
033		7	70x135	906
034		4	70x135	906
035		3	70x135	906
036		8	70x135	870
037		4	70x135	870
038		3	70x135	870
039		1	70x68	870
040		1	70x68	763
041		14	70x135	763
042		1	70x68	728
043		14	70x135	728
044		5	70x135	660
045		14	70x135	520
046		10	70x135	350
047		4	70x135	350
FH3	FUNDAMENTHÖLZER (imprägniert) 	1	70x95	3000
FH6	FUNDAMENTHÖLZER (imprägniert) 	1	70x95	2100
FH14	FUNDAMENTHÖLZER (imprägniert) 	1	70x95	1661

Pos		Stck	Profil (mm)	Länge (mm)
FH10	FUNDAMENTHÖLZER (imprägniert) 	2	45x95	4368
FH12	FUNDAMENTHÖLZER (imprägniert) 	2	45x95	4278
FH1	FUNDAMENTHÖLZER (imprägniert) 	4	45x95	3090
FH2	FUNDAMENTHÖLZER (imprägniert) 	8	45x95	3000
FH9	FUNDAMENTHÖLZER (imprägniert) 	2	45x95	2813
FH11	FUNDAMENTHÖLZER (imprägniert) 	2	45x95	2723
FH5	FUNDAMENTHÖLZER (imprägniert) 45° 	1	45x95	2435
FH8	FUNDAMENTHÖLZER (imprägniert) 	3	45x95	1920
FH13	FUNDAMENTHÖLZER (imprägniert) 	2	45x95	1908
FH15	FUNDAMENTHÖLZER (imprägniert) 45°  45°	1	45x95	1521
FH7	FUNDAMENTHÖLZER (imprägniert) 	3	45x95	990
FH4	FUNDAMENTHÖLZER (imprägniert) 45° 	1	45x95	447
HS1	HOLZSCHWELLE (unter der Saunatur)  ✓	1	75x28	750
PF2	 PFETTEN	1	58x170	5200
PF5	 PFETTEN	1	58x170	5200
PF4	 PFETTEN	1	58x170	4230
PF3	 PFETTEN	1	58x170	3670
PF1	 PFETTEN	2	58x170	2700
	DACHBRETTER 	68+1	113x18	3500
	FUSSBODENBRETTER  ✓	10+1	113x28	4255
	FUSSBODENBRETTER 	18	113x28	2225
	FUSSBODENBRETTER 	18	113x28	1955
	TERRASSENBRETTER (imprägniert)  ✓	10+1	120x28	2904-4029
	TERRASSENBRETTER (imprägniert) 	15	120x28	2795
	ABDECKLEISTEN  ✓		15x28	23.0lfm

Pos		Stck	Profil (mm)	Länge (mm)
	FUSSBODENLEISTEN 	✓	14x55	23.0lfm
BL-1	DACHBLENDEN 336mm 	2	18x336	3600
BL-2	DACHBLENDEN 336mm 	4	18x336	3818
BS-1	DACHBLENDEN- Blendenstützen 44x65 	12	44x65	200
VL-1	DACHBLENDEN- Verbindungsleisten 	2	18x120	336
UPB-1	DACHBLENDEN- U-Profil für Blenden 	✓	65x44	23.0lfm
DPL-1	DACHPAPPENLEISTEN 15x28 	✓	15x28	15.0lfm
T06-1	TRAUFENLEISTEN 18x40 	✓	18x40	15.5lfm
A70-1	ADAPTER 70  Obere seite 	✓	120x106	2260
TP1 20-1	STÜTZPFOSTEN 120x120 	✓	120x120	2090
TL70-1	T-LEISTE 70 	2	45x70	625
TL7 0-2	T-LEISTE 70 	4	45x70	1840
TL7 0-3	T-LEISTE 70 	2	45x70	1910
DzT 58-1	ECKTÜR- Deckbrett zum Tür 58 	1	18x58	1750
VK3-1	ECKTÜR- Verkleidungsleisten 95 für Vordachelement 	✓	95x18	1250
P9L4-1	ECKTÜR- linke Türpfoste 70 	1	90x90	2035
P9R 4-1	ECKTÜR- rechte Türpfoste 70 	1	90x90	2035
VE3	ECKTÜR- Vordachelement 1600x825 	1		
	DECKENISOLATION  	2 Elemente		ca 1950x975
SA0 2-1	SAUNA - Saunabank 50cm 	1	500x90	1355
SA01-1	SAUNA - Saunabank 60cm 	2	600x90	1955
SA16 -2-1	SAUNA - Bänke Zwischenstück 2 	1	46x300	1955
SA15 -2-1	SAUNA - Rücklehne 2 	2	72x250	1860

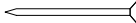

Pos		Stck	Profil (mm)	Länge (mm)
SA11-1	SAUNA - Stützpfosten für Saunabänke 	✓ 1	44x65	500
SA11-2	SAUNA - Stützpfosten für Saunabänke 	✓ 2	44x65	1000
SA10-1	SAUNA - Trägleiste für Saunabänke 	✓ 1	30x40	500
SA10-2	SAUNA - Trägleiste für Saunabänke 	✓ 2	30x40	600
SA10-3	SAUNA - Trägleiste für Saunabänke 	✓ 2	30x40	1200
SA20-1	SAUNA - Trägleiste für Deckenisolation 	✓ 4	35x35	2010
SA37	SAUNA - Bodenrost 	1		
SA30	SAUNA - Heizung Umbau (set 1) 	1		
SA35	SAUNA - Kopfstütze 	2		
SA36	SAUNA - Luftschieber 	3		
SA25-1	SAUNA - Dichtungsband für Deckenisolationselemente 	✓		8.0lfm
HK2	HOLZ-KLOTZEN für verbinden der Wandbohlen (122mm) 	1		
SH	Schlaghölzer 	3		
KP-1	DACHPAPPE 	✓	8.3m-5'st	45.0lfm
SS023	Schloßschrauben M8x70 Mutter M8 U-Scheibe Ø25 - Befestigung für Saunabänke 	2		
VS	VERBINDUNGSSTREIFEN für verbinden der Wandbohlen 	4		
VP3	Verstellbare Pfostenstütze M20 	1		
ML1	Metallstange 	1	D10	1040
ML2	Metallstange 	1	D10	970
ML3	Metallstange 	5	D10	900
ML4	Metallstange 	2	D10	770
ML5	Metallstange 	5	D10	360
ML6	Metallstange 	1	D10	330
NG01	DACHPAPPNÄGEL 2.8x15 	560		
NG04	NÄGEL 2.5x50 Dachbretter 	680		

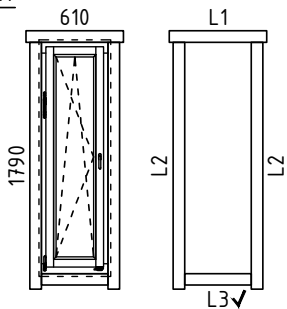
Pos		Stck	Profil (mm)	Länge (mm)
SR32	SCHRAUBEN 3.0x30 Abdeckleisten, Fussbodenleisten, Verbindungsleisten Dachpappenleisten, Traufenleisten 40x18 Bänke Zwischenstück, Luftschieber	191		
SR37	SCHRAUBEN 3.5x45 Heizung Umbau, Verbindungsstreifen	24		
SR3 547	SCHRAUBEN 3.5x45 C3 Fenster- und Türleisten	138		
SR3 547	SCHRAUBEN 3.5x45 C3 U-Profil	48		
SR44	SCHRAUBEN 4.0x60 Trägleiste für Saunabänke Trägleiste für Deckenisolation	49		
SR4 257	SCHRAUBEN 4.2x55 C2 28mm Fussbodenbretter	289		
SR4 267	SCHRAUBEN 4.2x65 C3 28mm Terrassenbretter	350		
SR57	SCHRAUBEN 5.0x100 Fundamenthölzer Stützpfeiler 120x120	145		
SR55	SCHRAUBEN 5.0x70 Blendenbefestigung Verstellbare Pfostenstütze Stützpfeiler für Saunabänke	74		
SR509 0-001	SCHRAUBEN 5.0x90 Sauna- Rücklehne 2, LR	20		
SR61	SCHRAUBEN 6.0x140 Blendenstützen	24		
KL-1	Gewindestange M12 - für die Pfetten	6		170
MUT26	Mutter M12 U-Scheibe Ø30 - für die Pfetten	12		
KL1	Gewindestange M8	3		2000
KL2	Gewindestange M8	1		564
KL3	Gewindestange M8	1		509
KL4	Gewindestange M8	2		460
KL5	Gewindestange M8	1		374
KV M UT M8	Mutter M8	10		
KV S EIB M8X25	U-Scheibe M8 Ø25	10		
KV MU TJ M8	Befestigungsmutter M8	3		
	<p>FENSTER Q4</p>  <p>610x1790</p> <p>A58-10 spez</p> <p>L1 18x90 L=850mm 2* L2 18x90 L=1910mm 4* L3 18x90 L=610mm 2* ✓</p> <p>1x DIN links / 1x DIN rechts</p>	2		





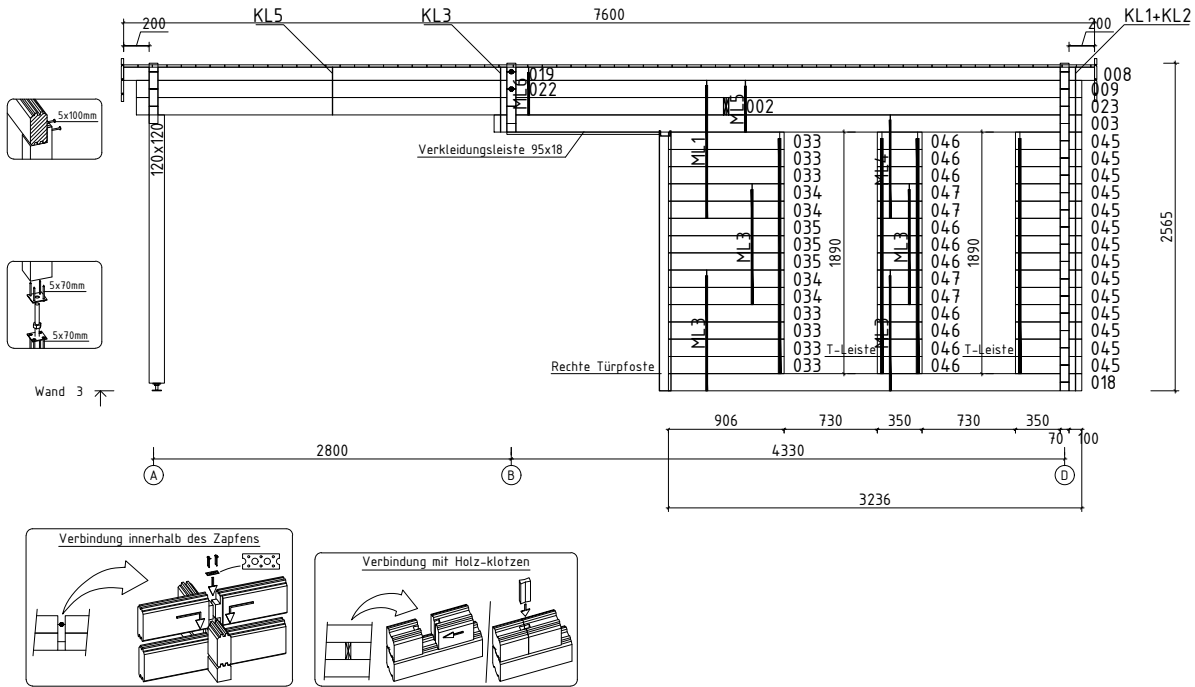

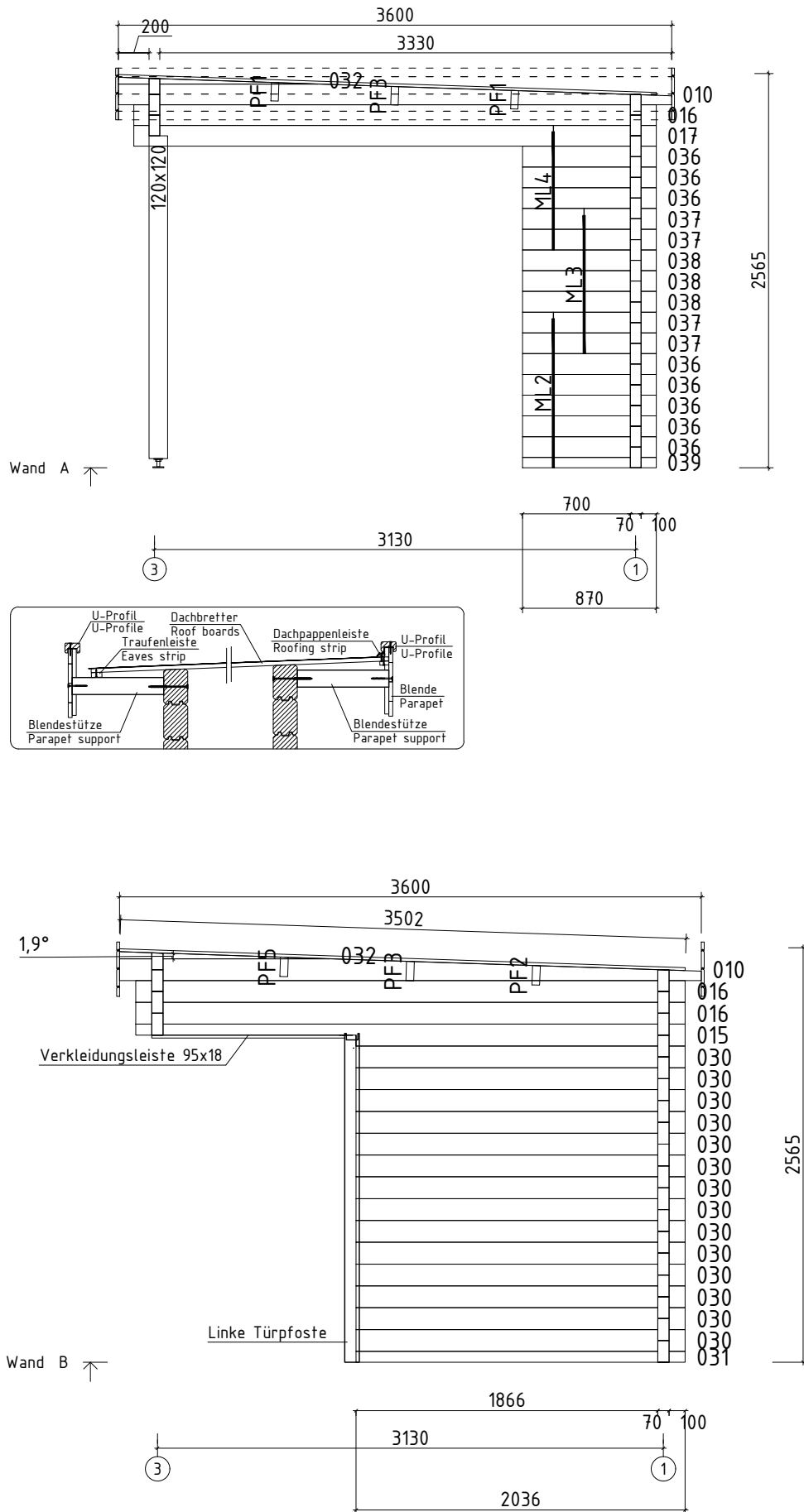



### Zuschneiden der Terrassenbretter 120x28mm

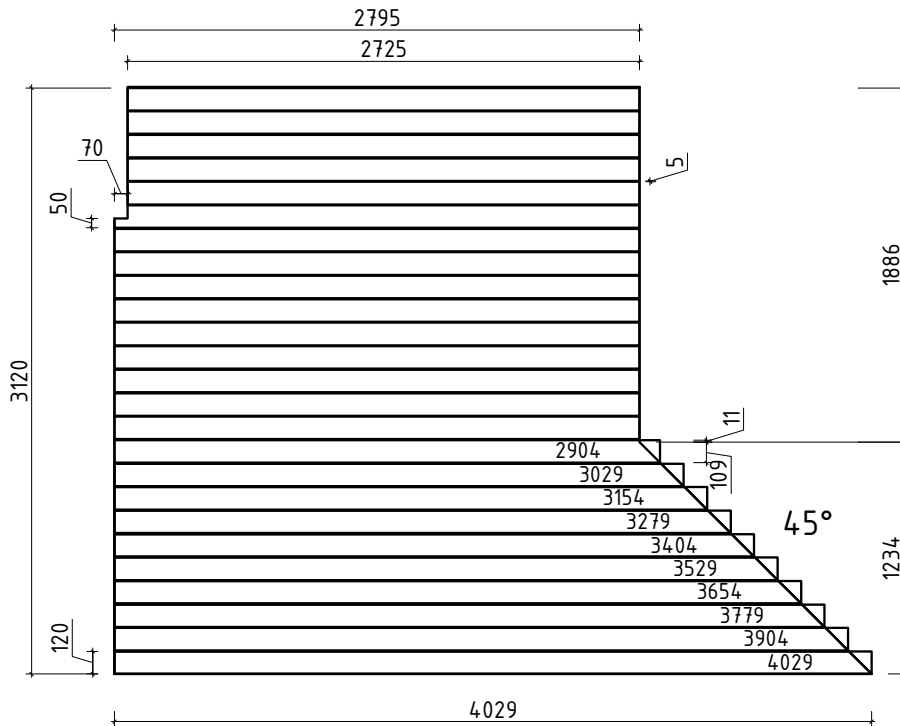

### Zuschneiden der Fussbodenbretter 113x28mm

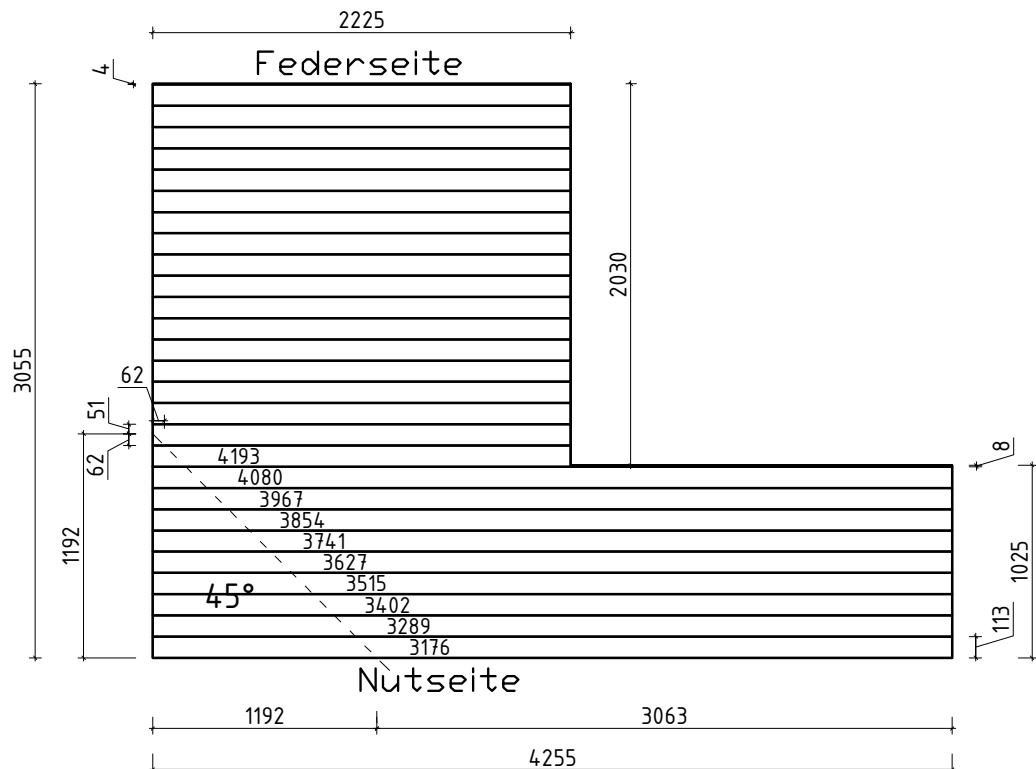



## Montageanleitung für T-leisten / Installing the door and window supports / Tenderliistu paigaldusjuhend.

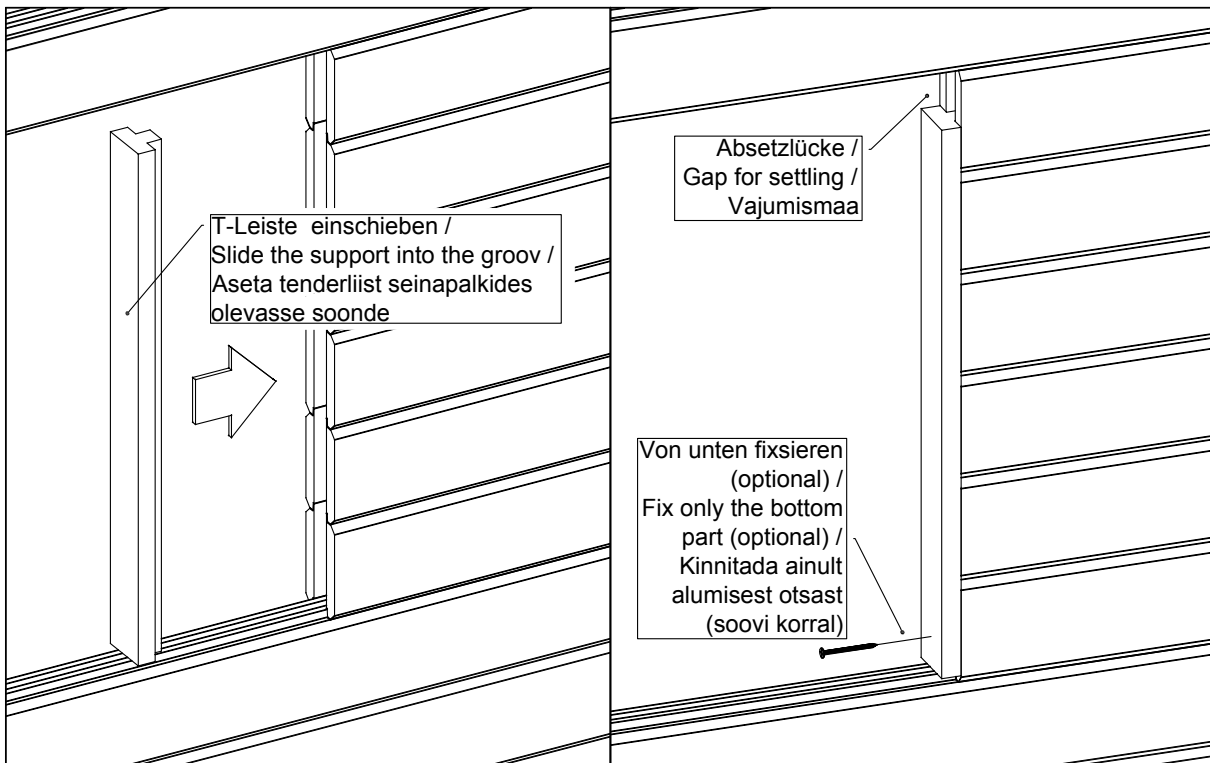

- Q4-Q6 - paigaldusjuhised
- Q4-Q6 - assembly instructions
- Q4-Q6 - Montageanleitung

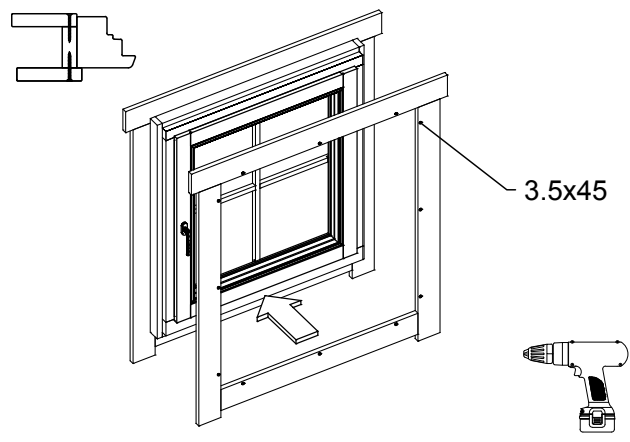
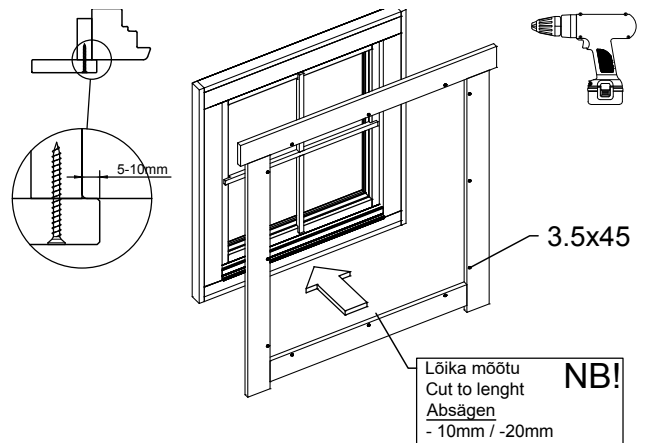
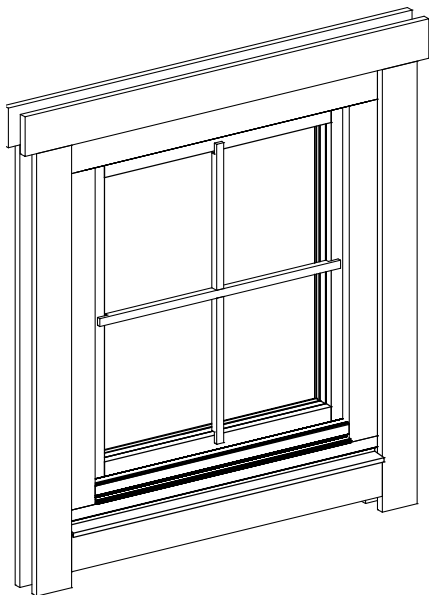

Veeplekk / Window sill / Fensterbank

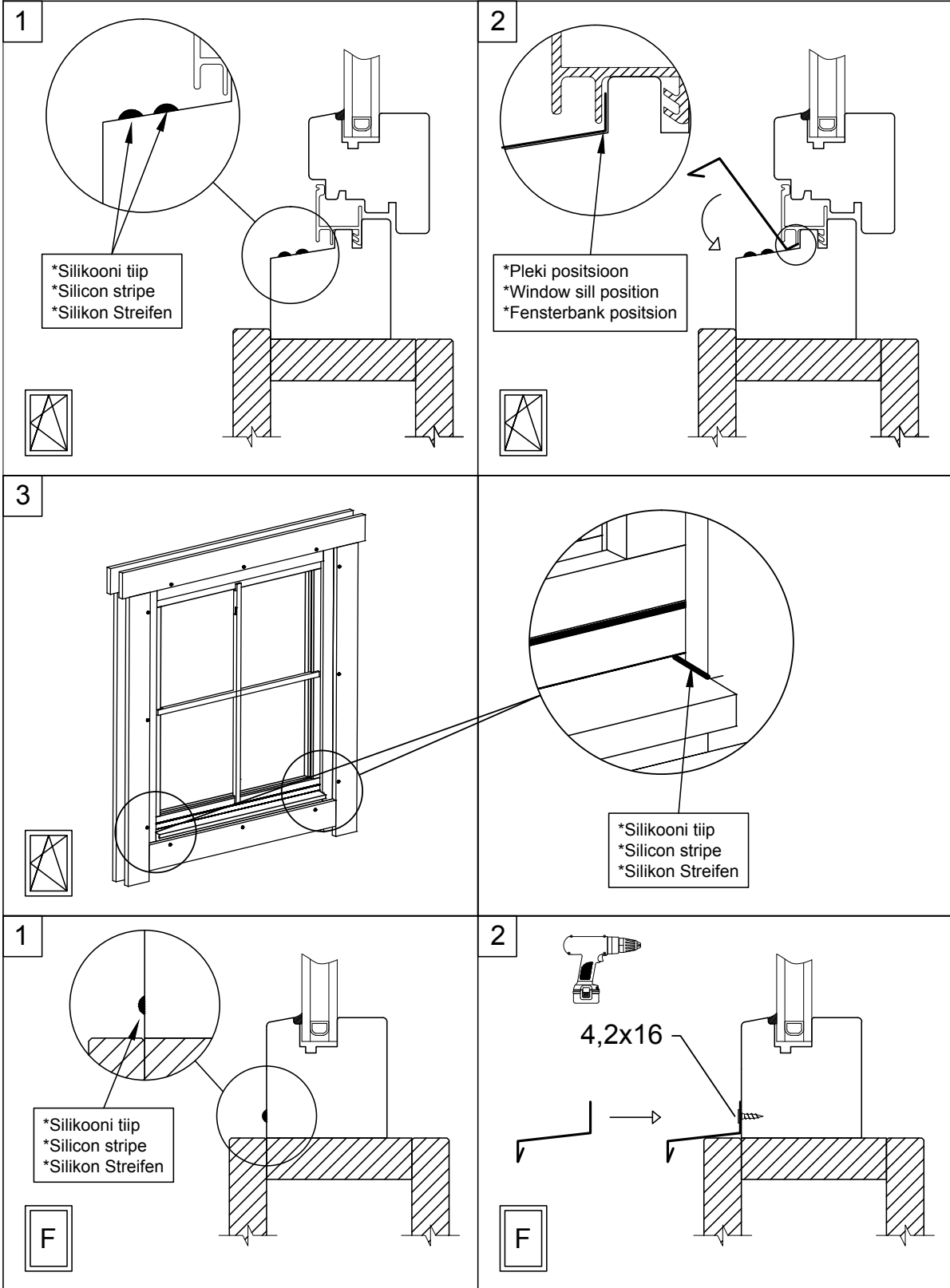

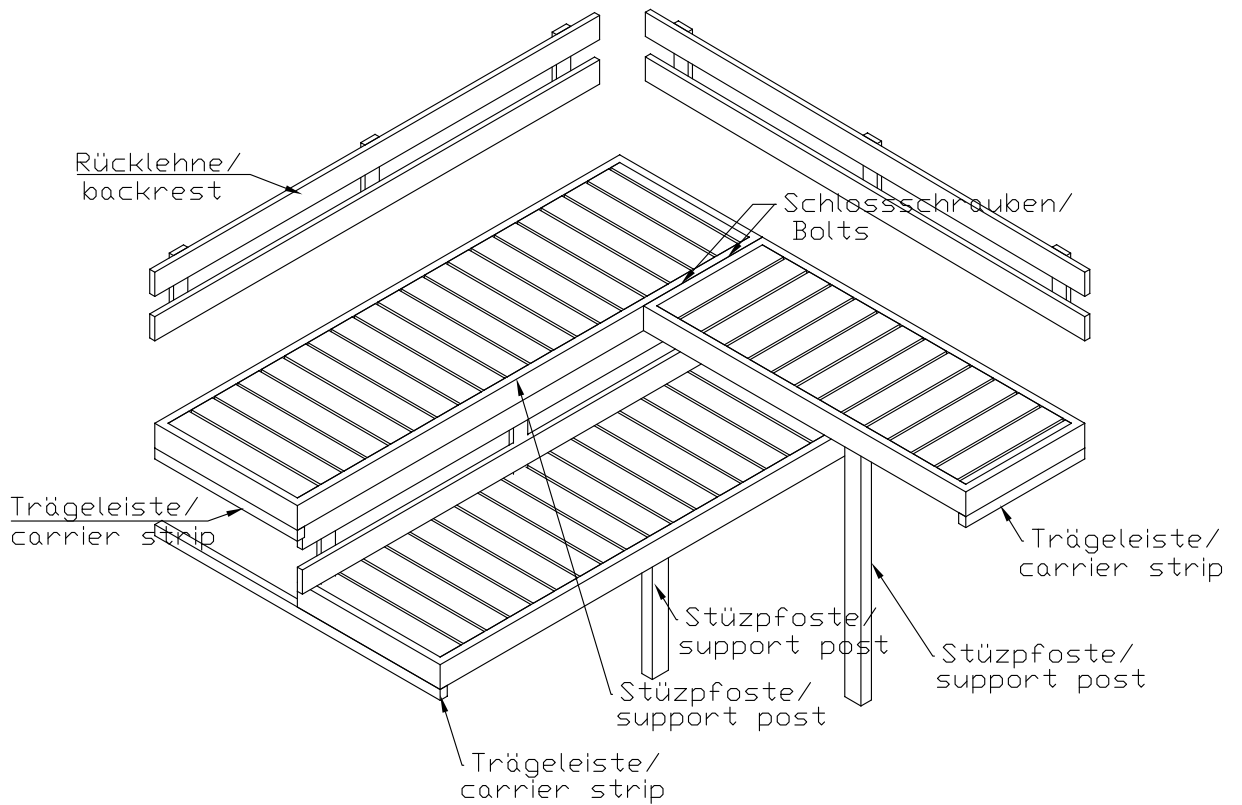

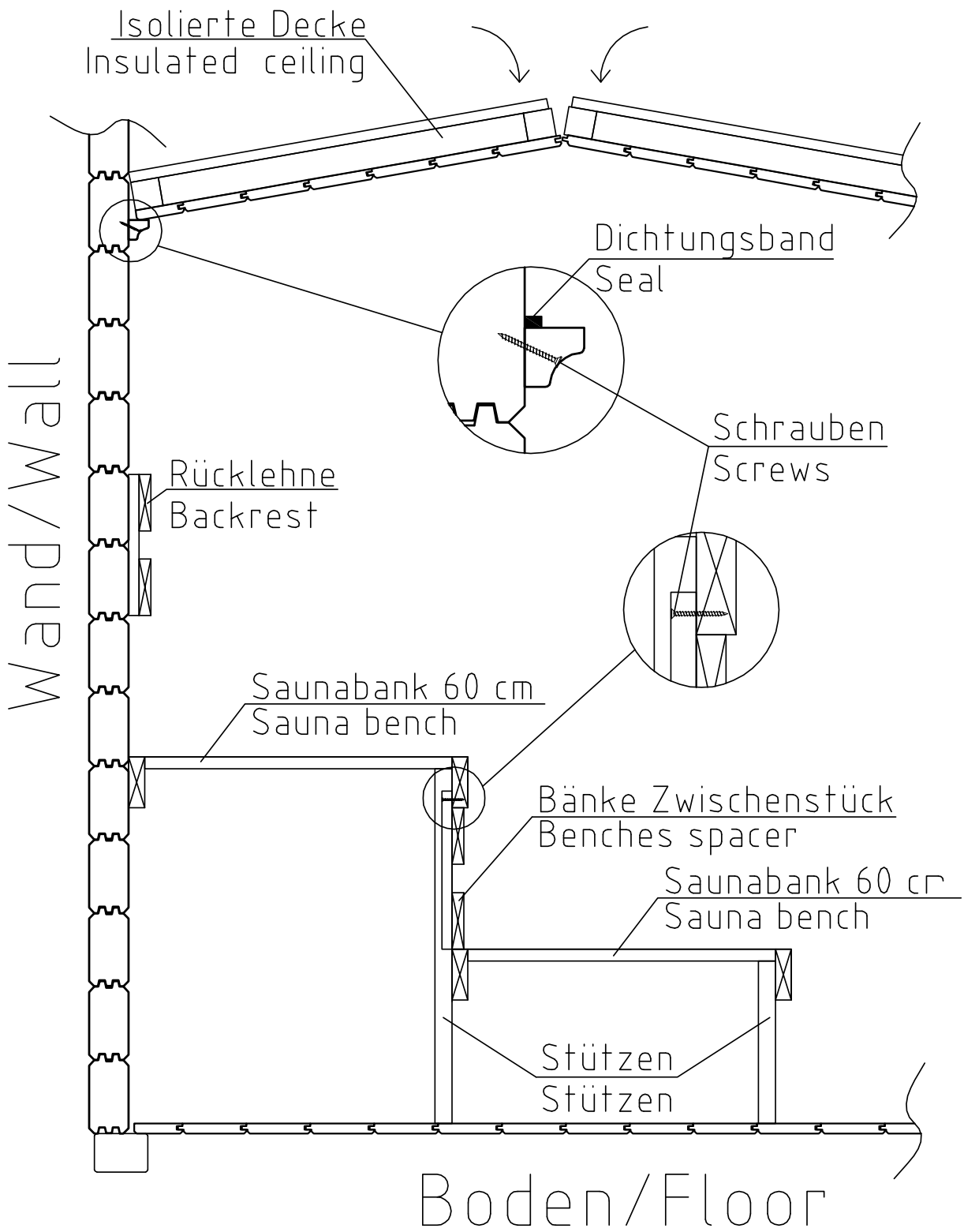

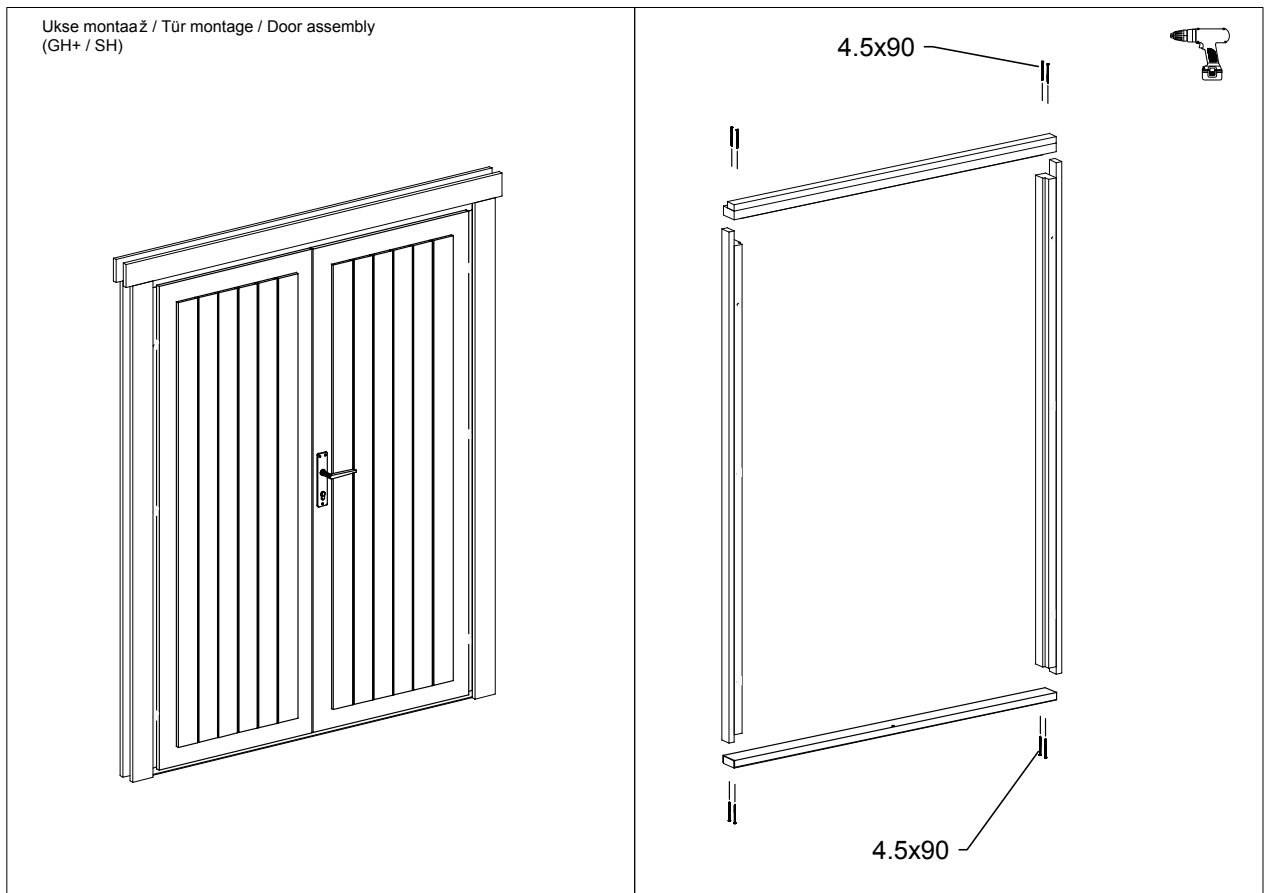

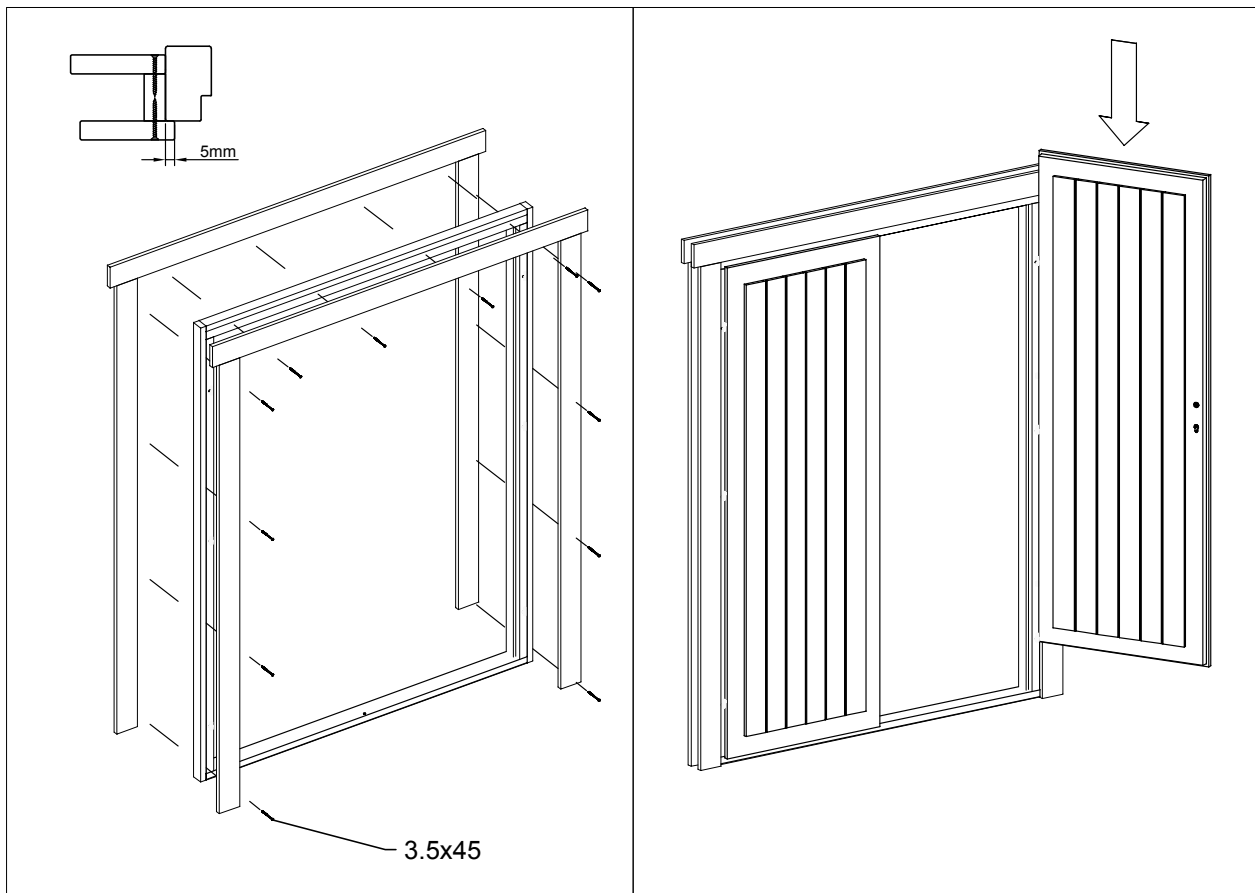

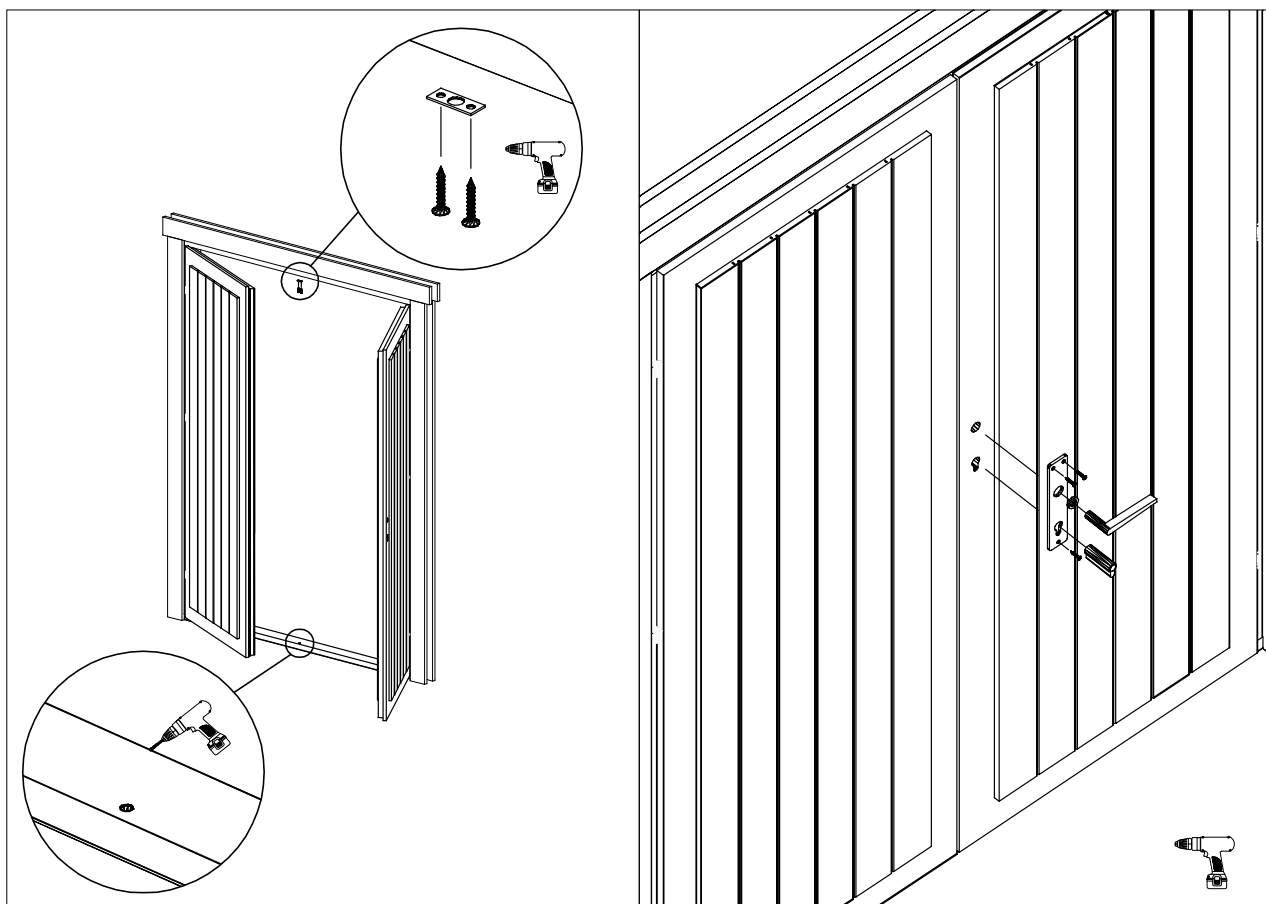



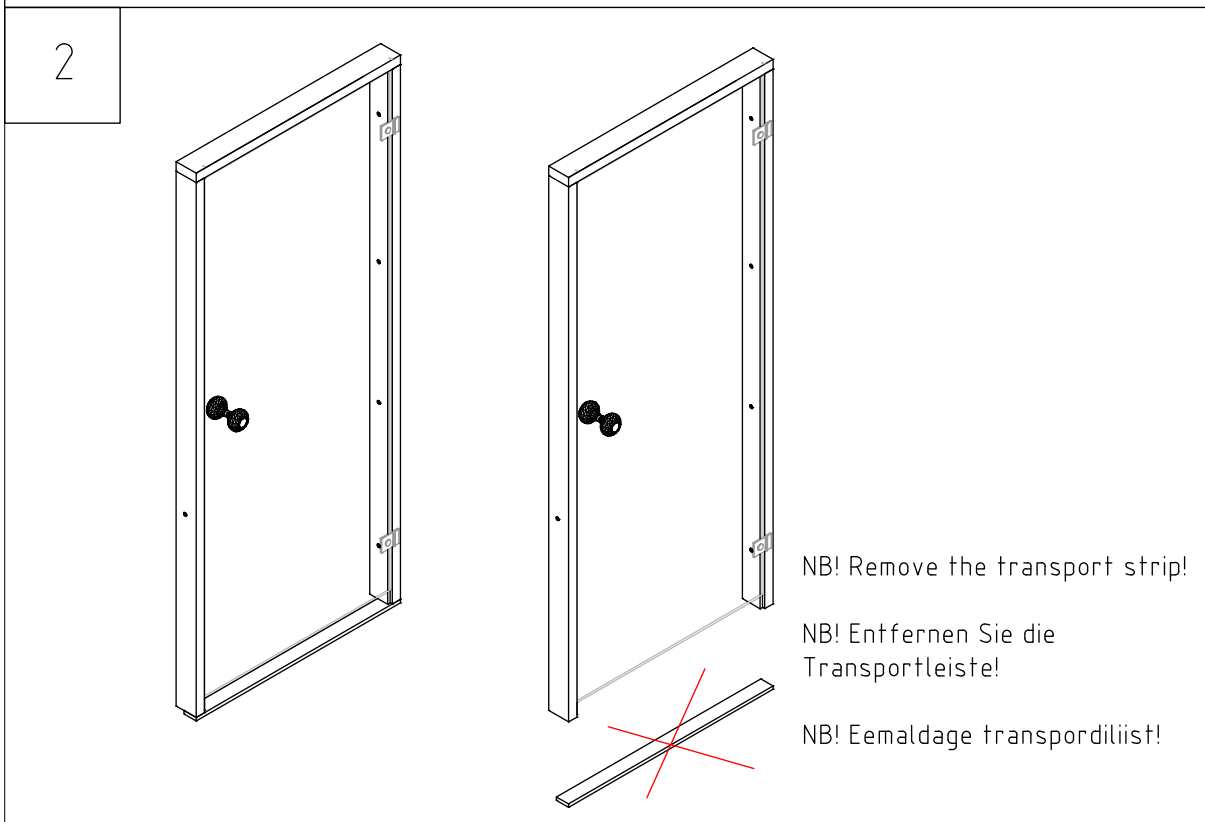
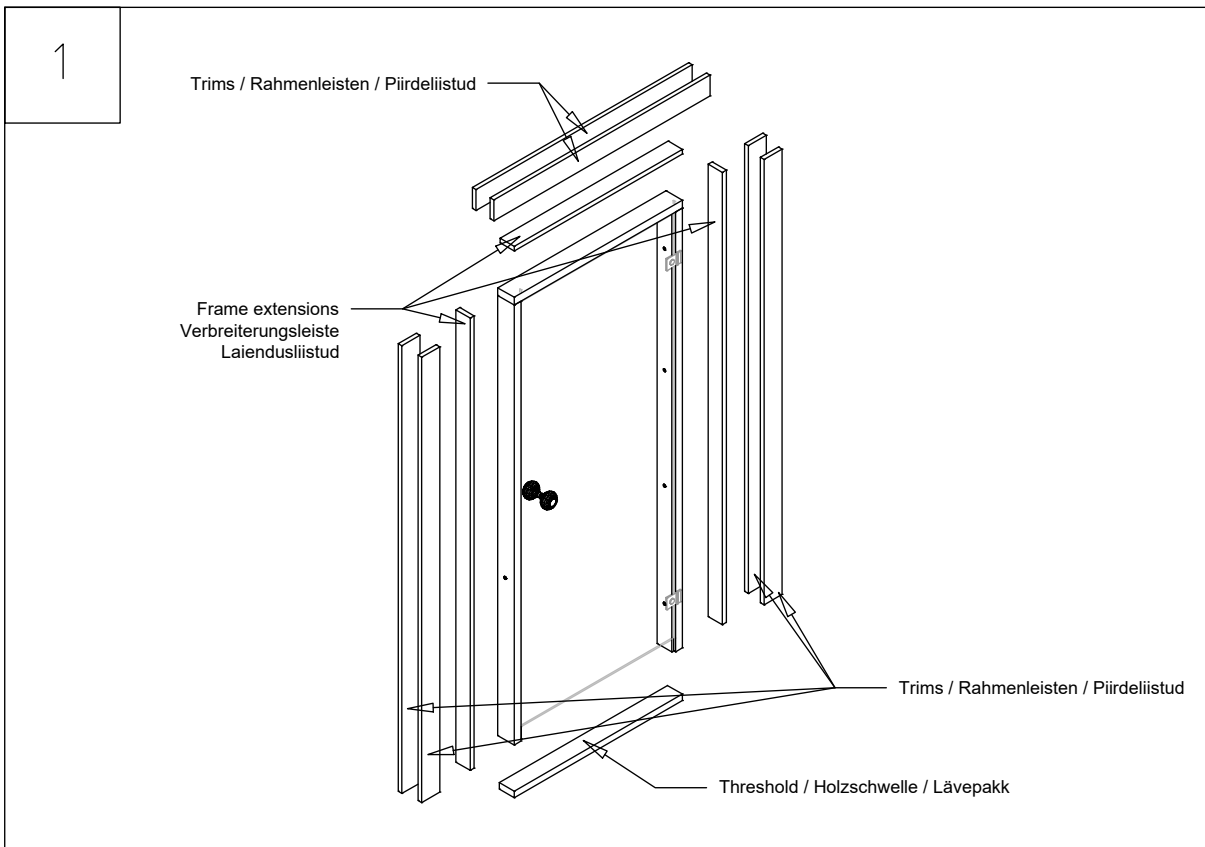

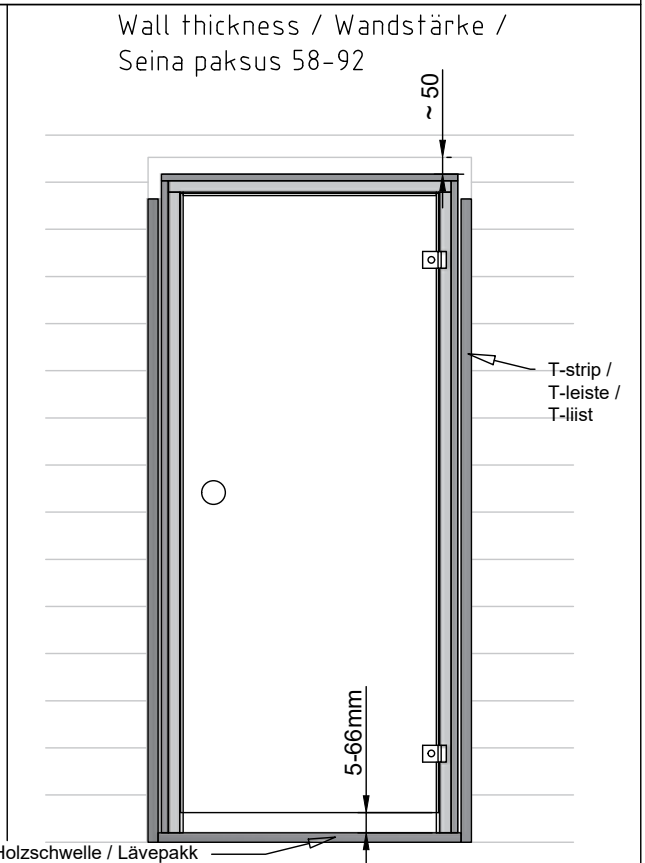
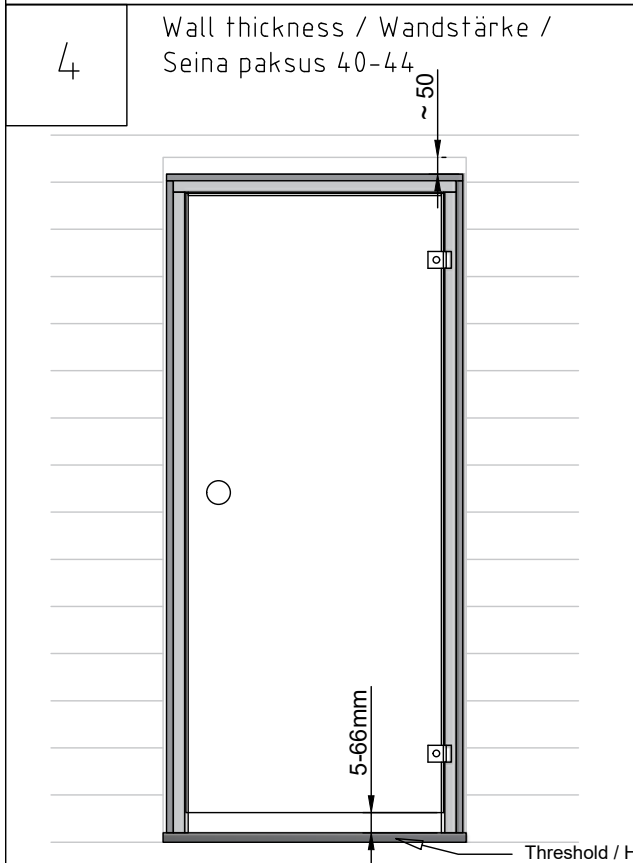
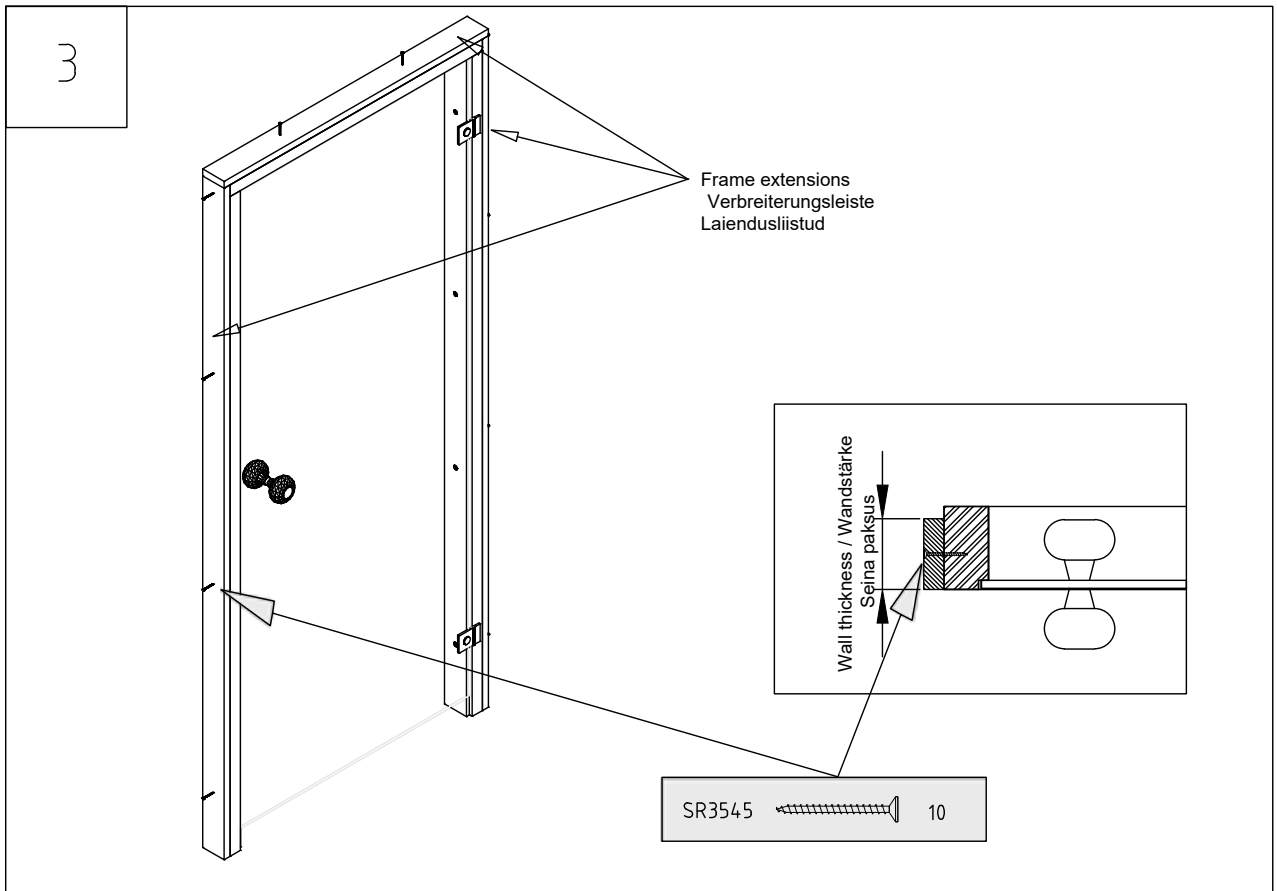

5

Wall thickness / Wandstärke / Seinä paksus 40-44

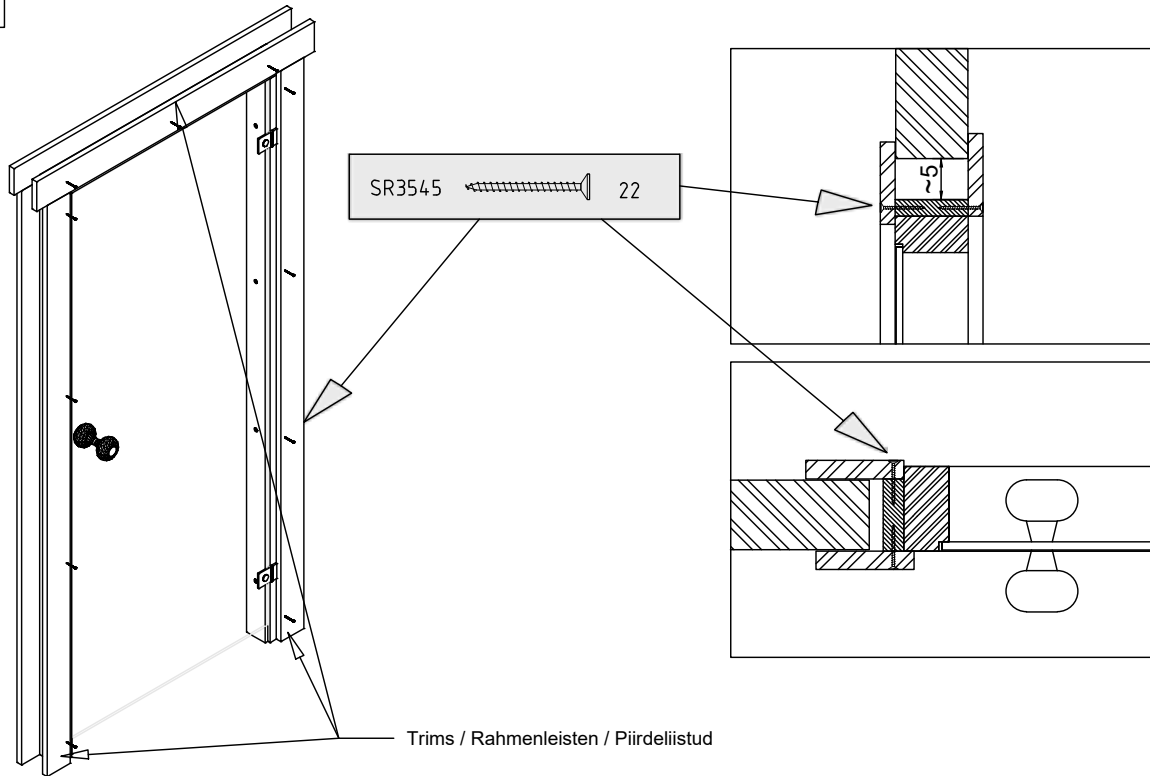

5

Wall thickness / Wandstärke / Seinä paksus 58-92

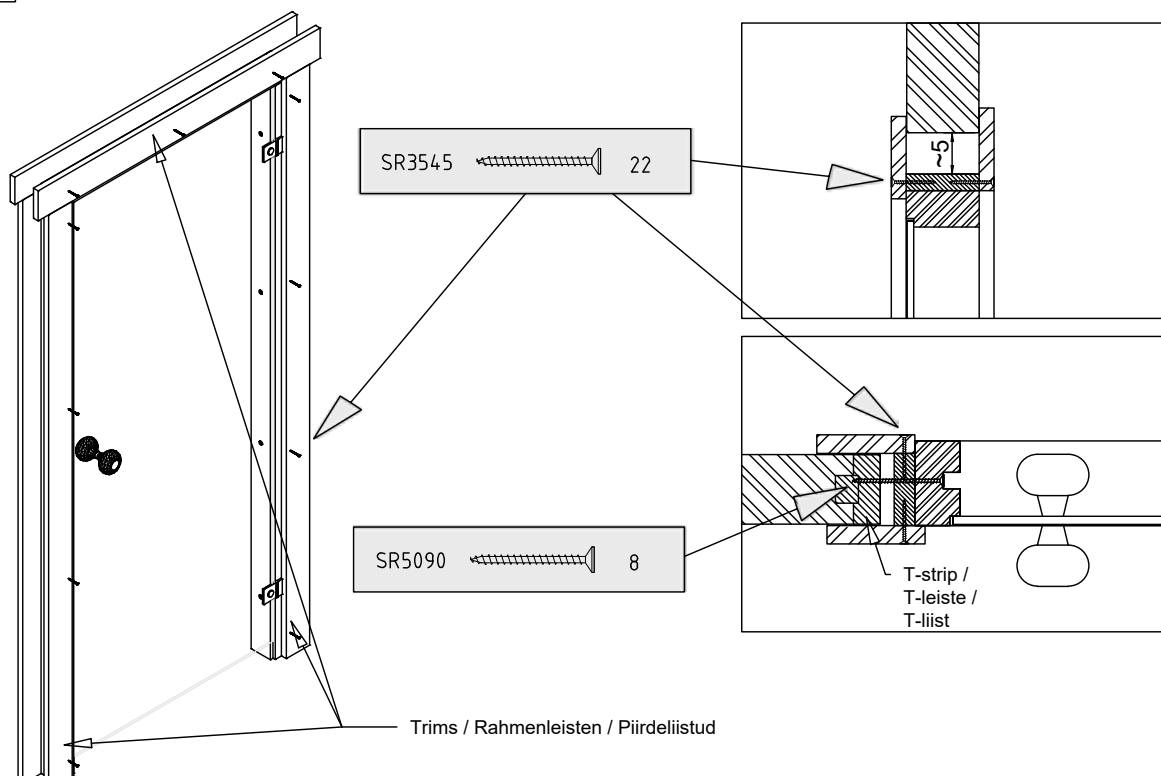

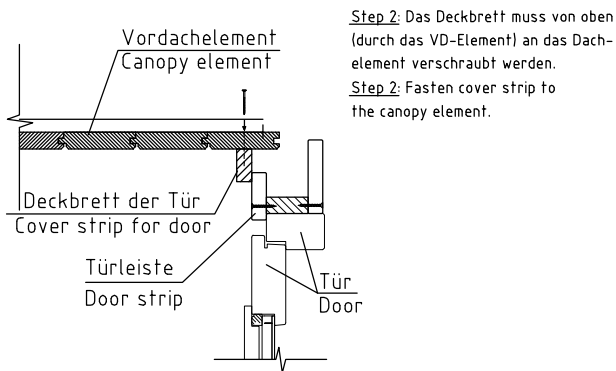
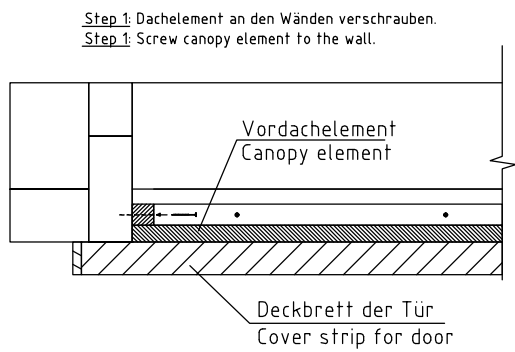

**Step 3:** Die Verkleidungsleisten in die richtige Länge schneiden und unter das VD-Element befestigen.  
**Step 3:** Cut trim strips to size and fasten under the canopy element.

