

Dallas 40
Art. Nr. 4023650
1/6

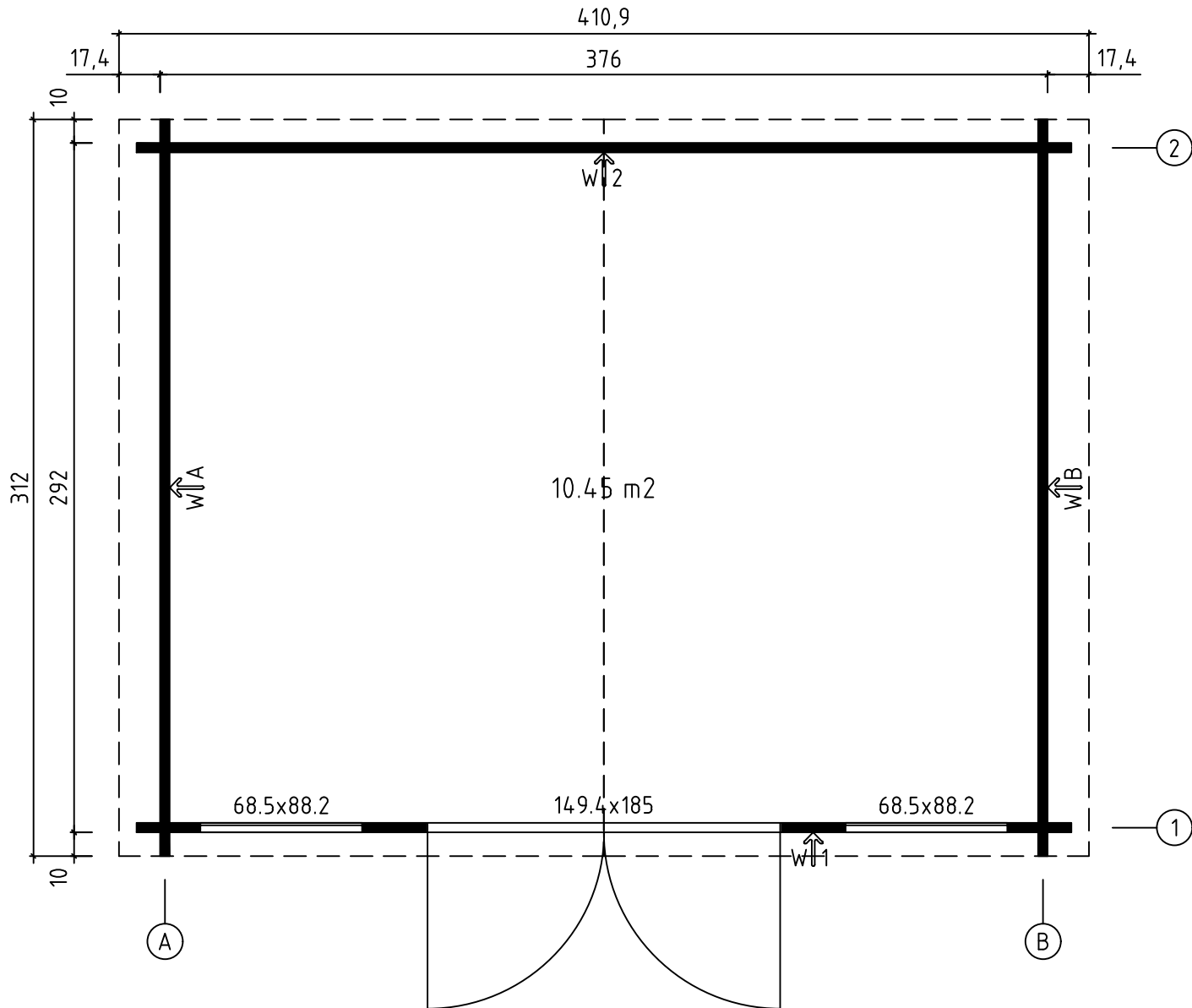

Art. Nr. 4023650

Groundplan - Grundplan - Plan de masse - Planimetria - Plattegrond - Põhiplaan









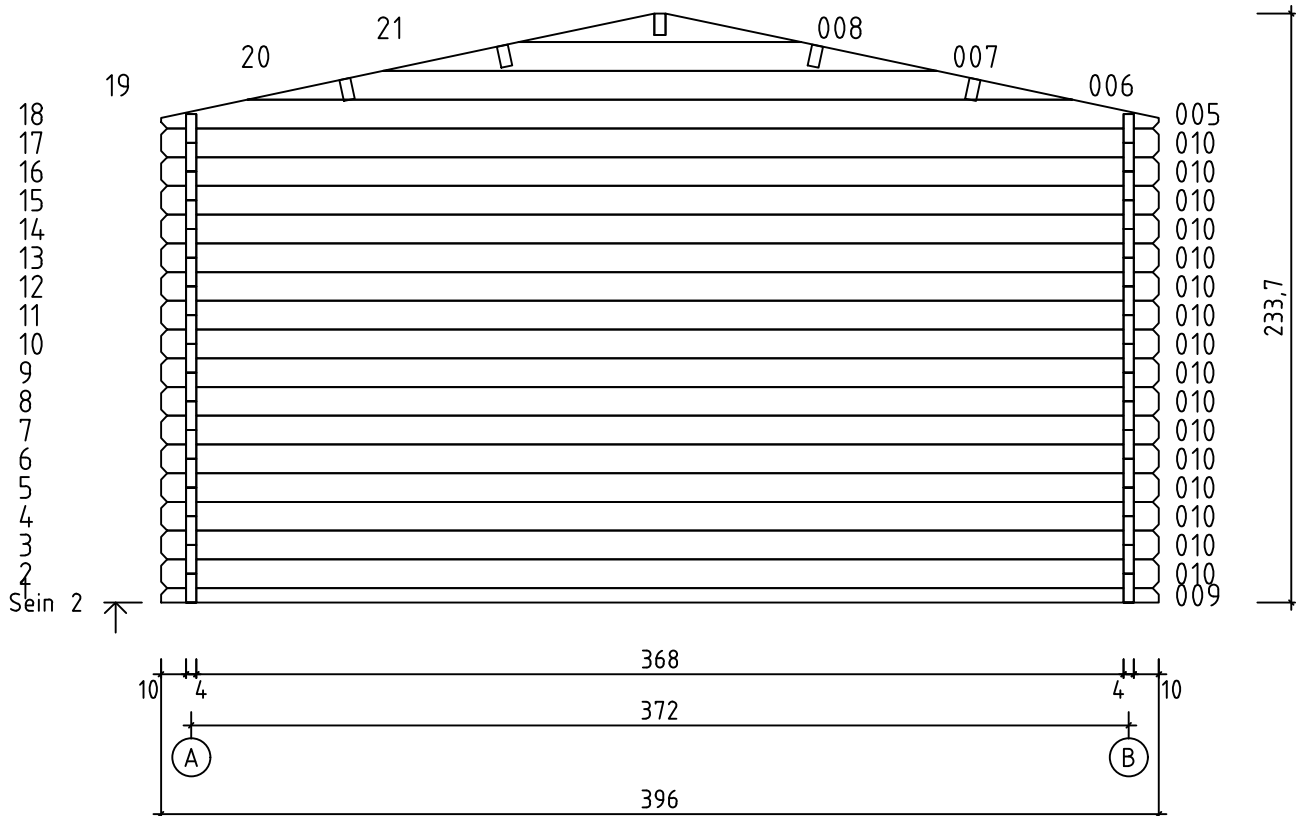
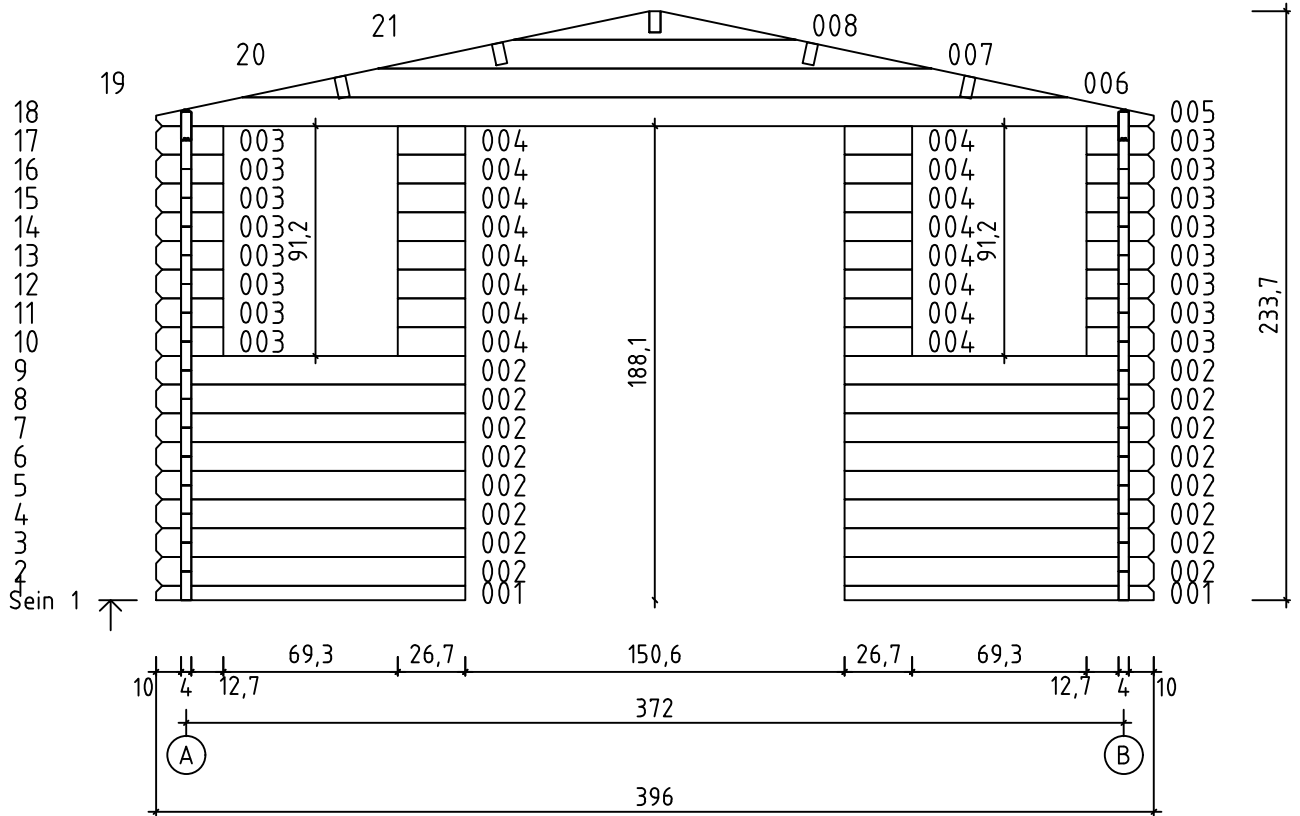

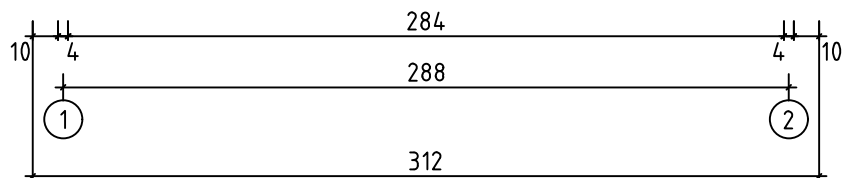
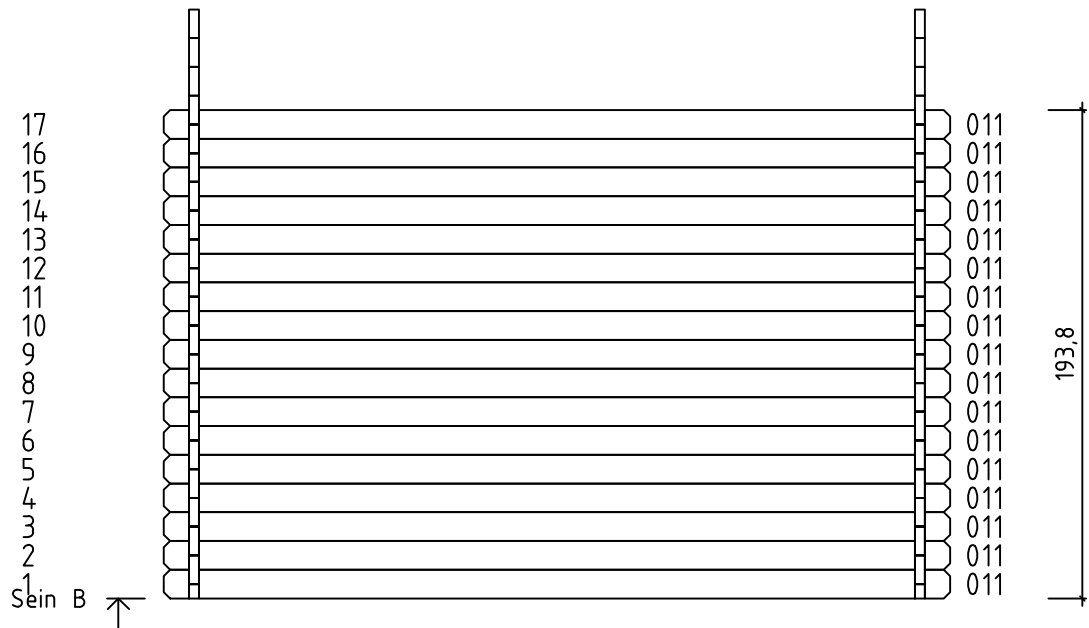
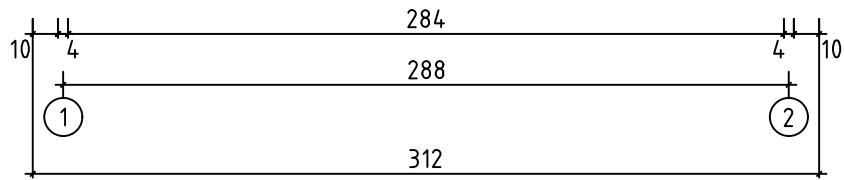
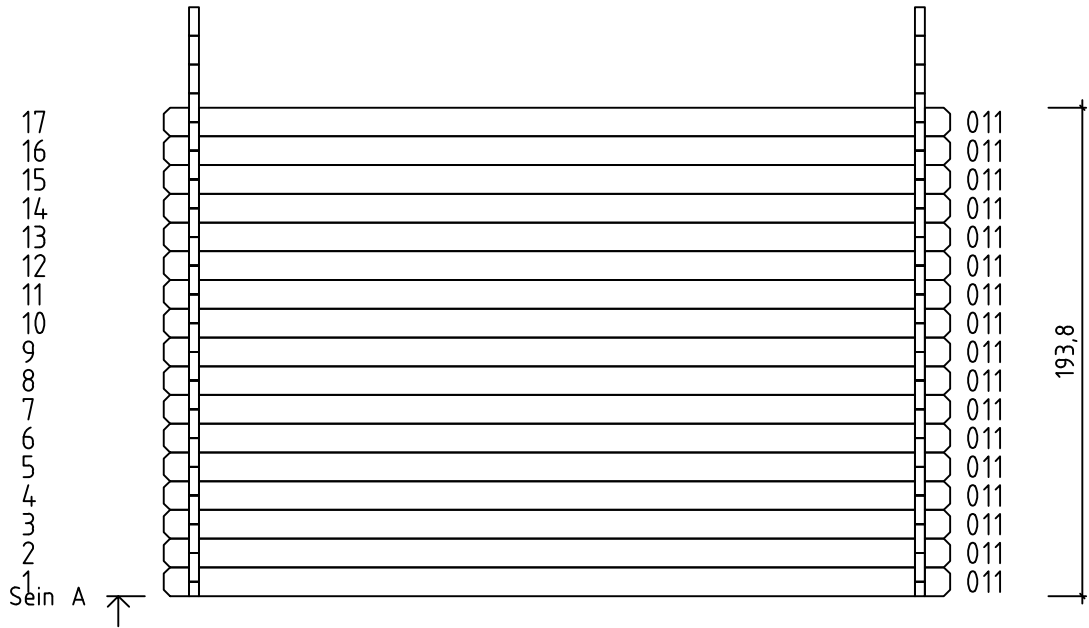

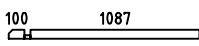
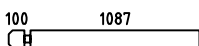
03.03.2022

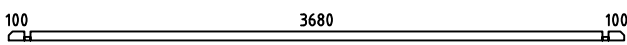
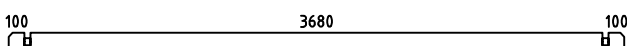
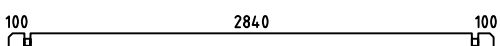
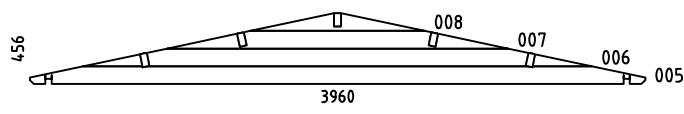
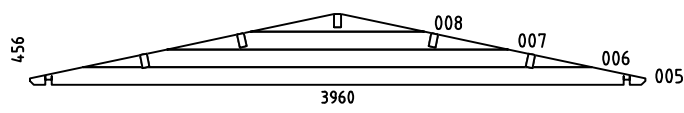
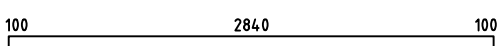
2/6

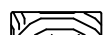
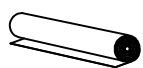

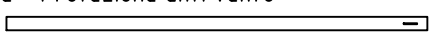
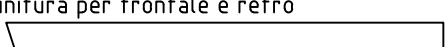
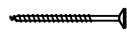

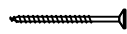

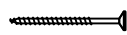
Art. Nr. 4023650

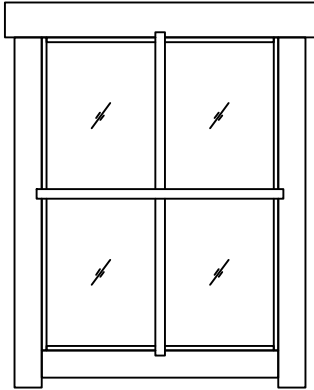
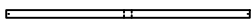
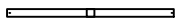
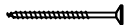

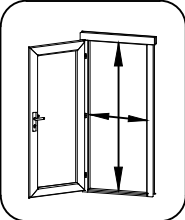
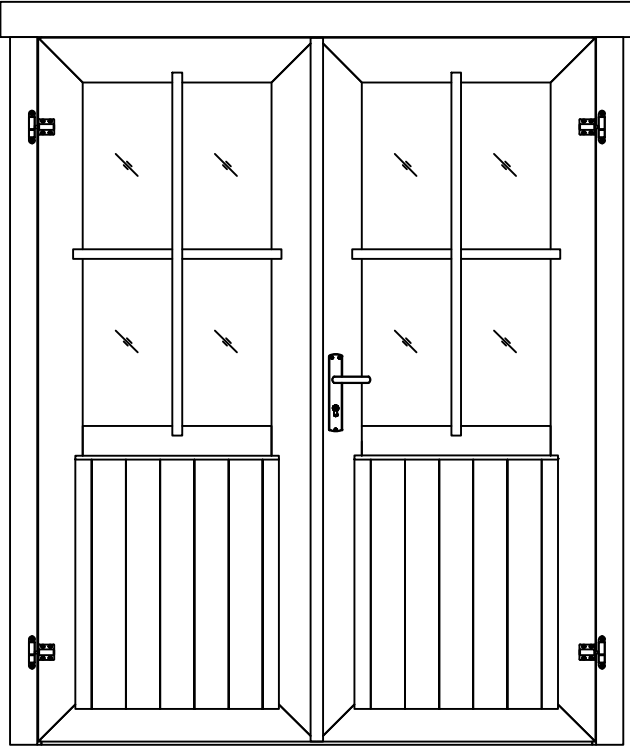

Pos	03.03.2022 Piece list - Stückliste - Liste des pièces - Elementi - Stuklijst - Tükitalabel Art. Nr. 4023650 5/6	Q	P (mm)	L (mm)
001		2	40x57	1227
002		16	40x114	1227
003		16	40x114	267
004		16	40x114	267
009		1	40x57	3960
010		16	40x114	3960
011		34	40x114	3120
W1-1		1		
W2-1		1		
A-PR1		5	44x140	3120
	Roof boards - Dachbretter - Voliges - Perlina per tetto - Dakhout - Katuselaud 	70	90x15	2100
	Roofing felt fillet - Dachpappenleiste - Baguette de fixation du feutre bitumeux - Asse per fissaggio guaina bituminosa - Afdeklijst asfaltpapier - Katusepapiilist 	4	15x45	2150
DPP-1	Roofing felt (strip) - Dachpappe (bahnen) - Feutre bitumeux (bande) - Cartone catramato - Asfaltpapier (baan) - Katusepapp 	5		3220
DRV-1	Roof edge reinforcement - Dachrandverstärkung - Corniere de renfort de bord de toit - Rinforzo x tetto - Dakrand versterking - Räästatugevdus 	2	15x45	3120
KFS-1	Storm protection - Sturmleiste - Latte anti-tempete - Protezione anti vento - Stormverankering / beveiliging - Tormikinnitusliist 	4	22x45	2050
	Gable moulding - Giebelleiste - Planche de rive - Finitura per frontale e retro del tetto - Gevellijst - Viilulaud 	4	15x120	2150
HS8	Screw for gable segment - Schrauben für deckblatt - Vis pour fixation losange de finition - Viti x frontali tetto - Schroef voor gevelpunt segment - Kruvi rombile 	4	3.5x35	
HS9	Screw for gable moulding - Schrauben für giebelleiste - Vis pour fixation planche de rive - Vite per fissare finiture davanti e dietro del tetto - Schroef voor gevellijst - Kruvi viilulauale 	32	3.5x50	
HS4	Screw for roof edge reinforcement - Schrauben für dachrandverstärkung - Vis pour fixation corniere de renfort de bord de toit - Viti x rinforzo bordo tetto - Schroef voor dakrand versterking - Kruvi räästatugevdusele 	14	3x30	
HS18	Screw for roof beams - Schrauben für dachbalken - Vis pour fixation pannes de toit - Viti per perline del tetto - Schroef voor gordingen / dakbalken - Kruvi pärlinitele 	10	5x120	
HS18	Screw for gable - Schrauben für giebel - Vis pour fixation des pignons - Viti per timpano - Schroef voor gevelpunt - Kruvi viilude kinnitamiseks 	4	5x120	

Pos	Piece list - Stückliste - Liste des pièces - Elementi - Stuklijst - Tükítabel 685x882 AK.1.104.SM0.f SGA	1/1	Q	P (mm)	L (mm)
	Glass size - Glasgröße - Taille de la vitre - Misura del vetro - Glas afmeting - Klaasi mõõt: 605x802 mm				
					
1	Georgian bars - Sprossen - Croisillons - La griglia georgiana - Raamverdeling - Petteliistud		1	15x25	832
2	Georgian bars - Sprossen - Croisillons - La griglia georgiana - Raamverdeling - Petteliistud		1	15x25	635
HS1	Screw for georgian bars - Schraube für sprossen - Vis pour croisillons - Viti per unire la griglia georgiana della finestra - Schroeven voor raamverdeling - Kruvi akna petteliistule		4	2.5x20	

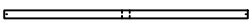
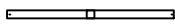
Pos	18.12.2017	Piece list - Stückliste - Liste des pièces - Elementi - Stuklijst - Tükítabel 14.94x1850 TUK.2.044.SVP.MX28 SGA+28	1/2	Q	P (mm)	L (mm)
Glass size - Glasgröße - Taille de la vitre - Misura del vetro - Glas afmeting - Klaasi mõõt: 502x900 mm					 1418x1794 mm	
						
1	Upper door jamb - Türrahmen oben - Cadre de porte supérieur - Telaio superiore della porta - Bovendorpel - Ukse ülemine leng			1	66x100	1628
2	Left door jamb - Türrahmen links - Cadre de porte gauche - Telaio montante sinistro della porta - Linkerstijl deurframe - Ukse vasak leng			1	66x80	1850
3	Right door jamb - Türrahmen rechts - Cadre de porte droit - Telaio montante destro della porta - Rechterstijl deurframe - Ukse parem leng			1	66x80	1850
4	Doorstep - Swelle - Barre de seuil - Soglia della porta - Deurdorpel - Lävepak			1	18x18	1418
5	Connection strip - Deckleiste - Baguette de battement - Profilo verticale della porta - Stulplijst - kokkuvaltsiliist			1	13x32	1812
6	Georgian bars - Sprossen - Croisillons - La griglia georgiana - Raamverdeling - Petteliistud			2	15x25	934
7	Georgian bars - Sprossen - Croisillons - La griglia georgiana - Raamverdeling - Petteliistud			2	15x25	536

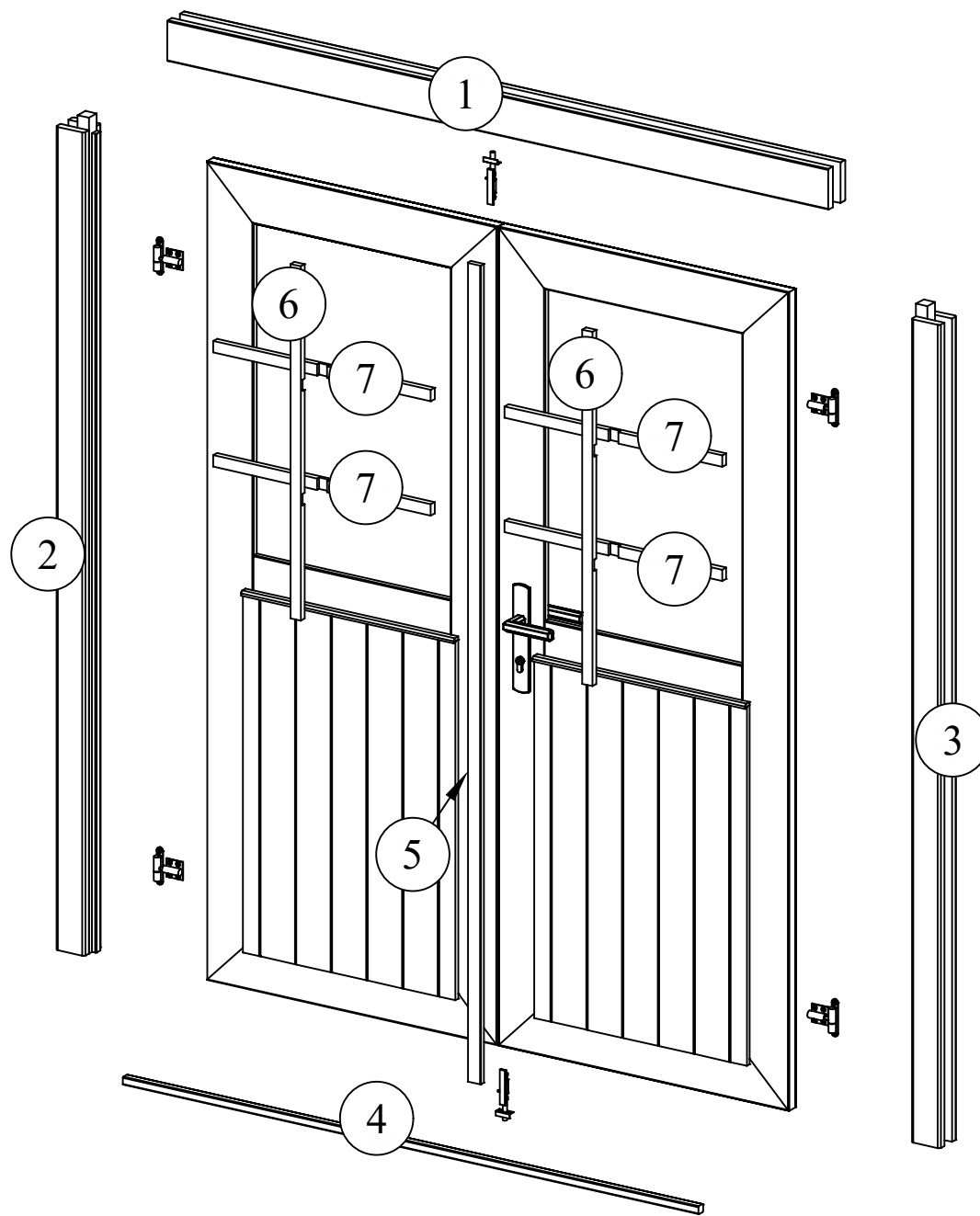

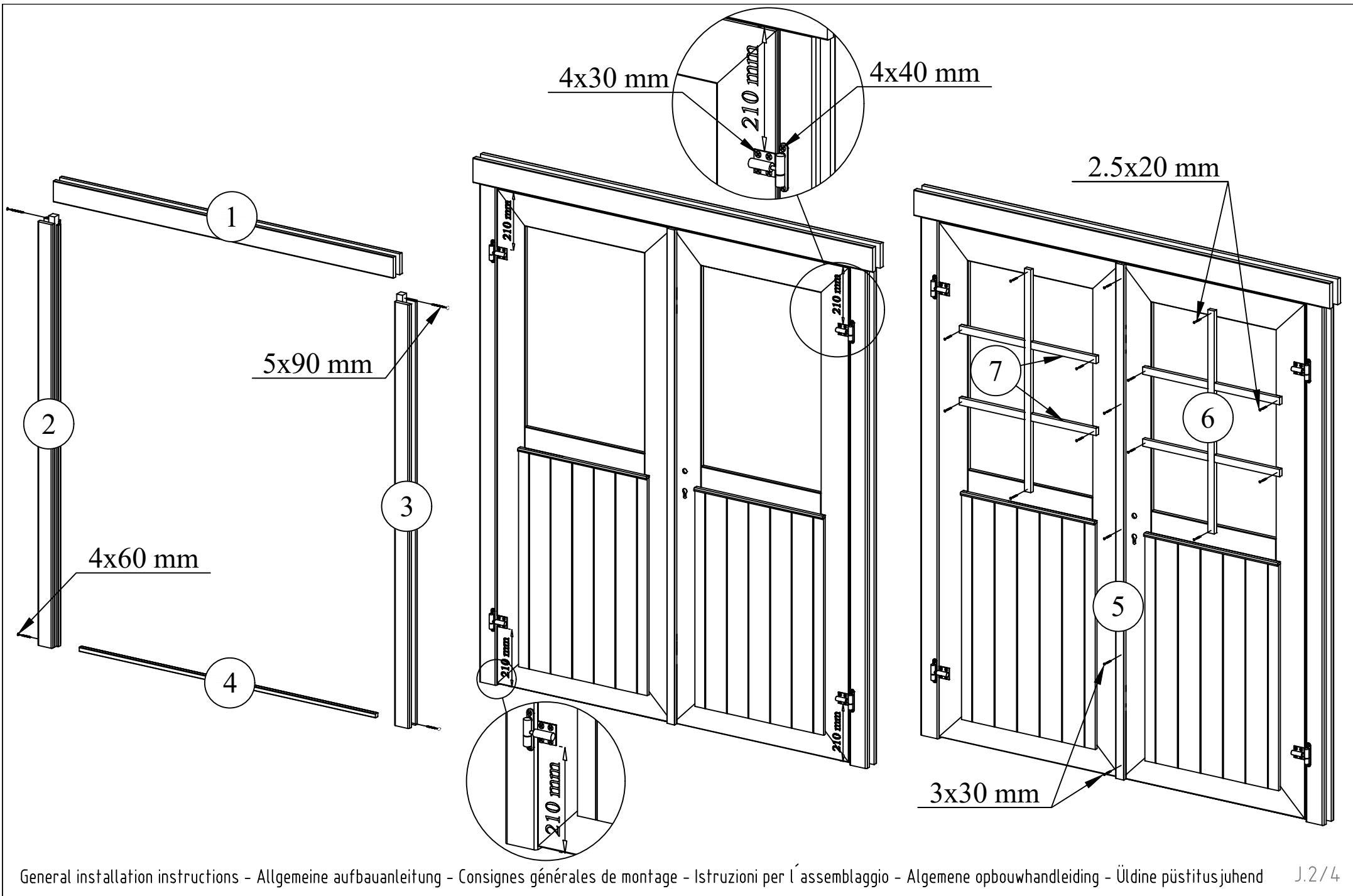

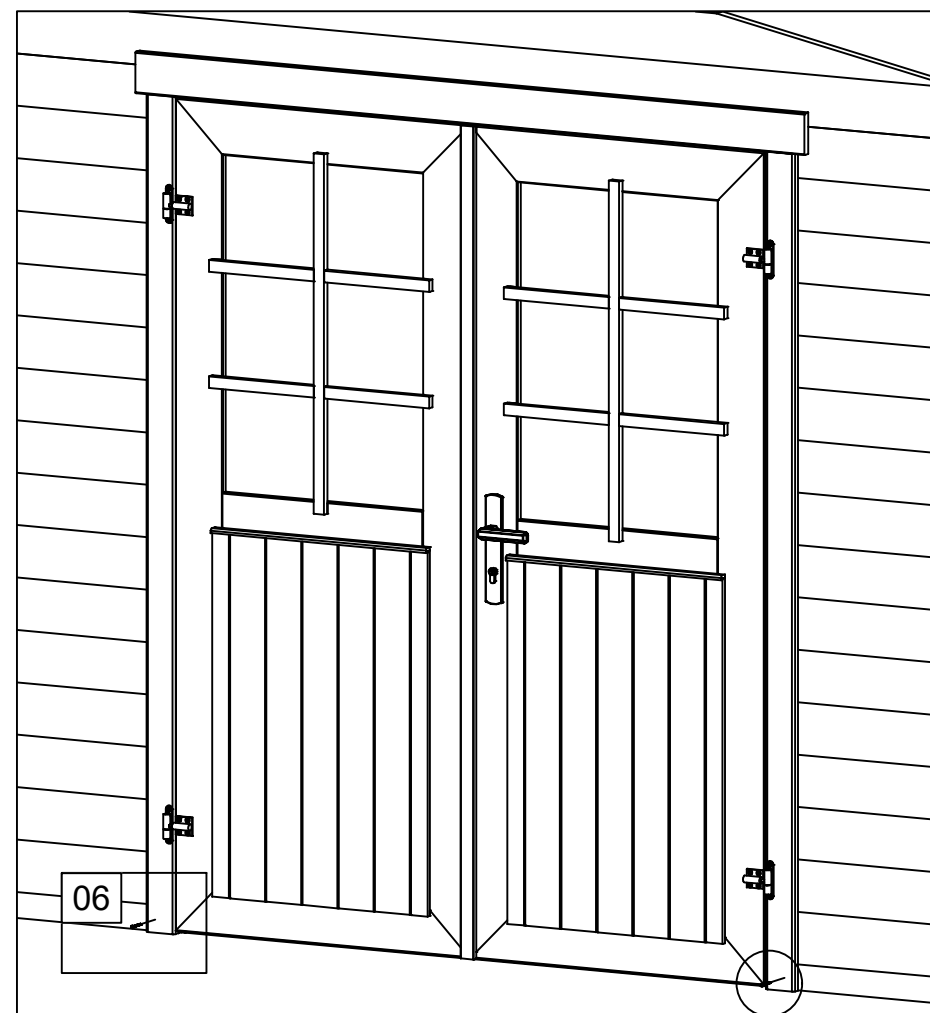
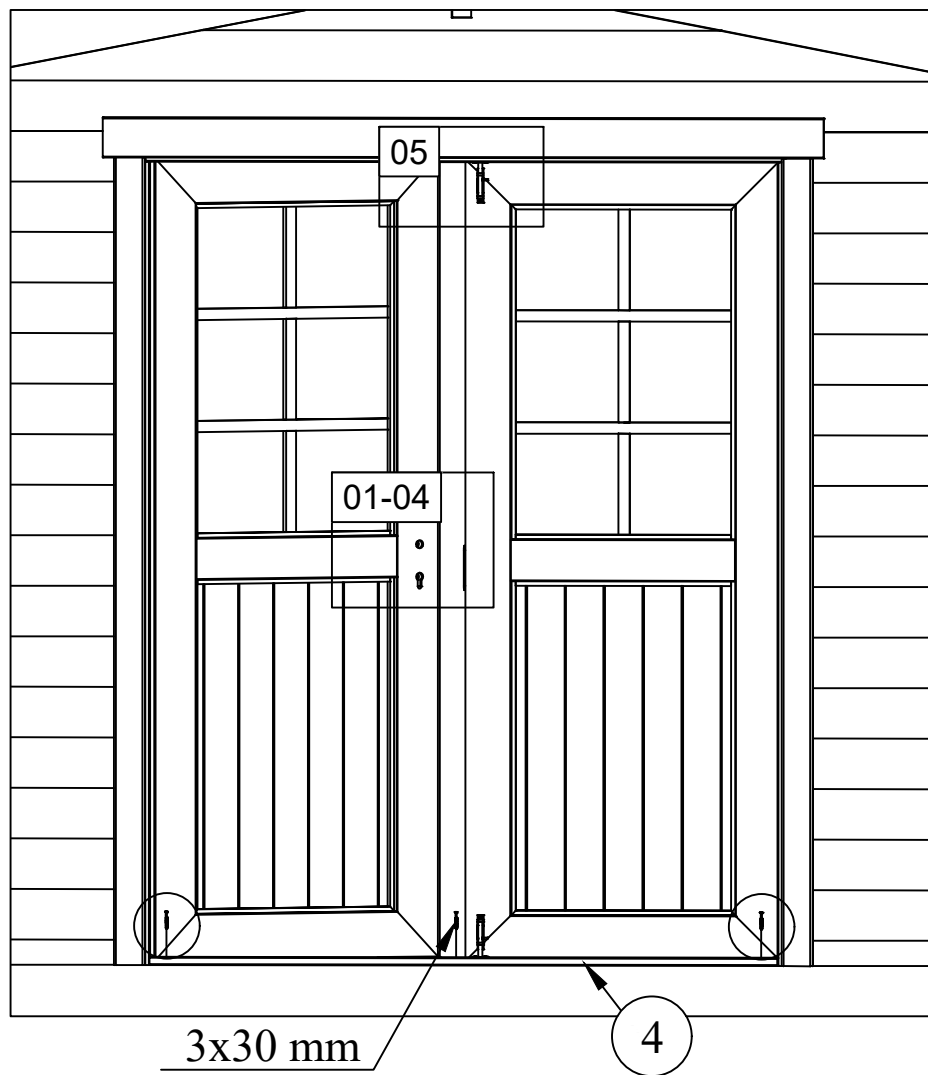

01

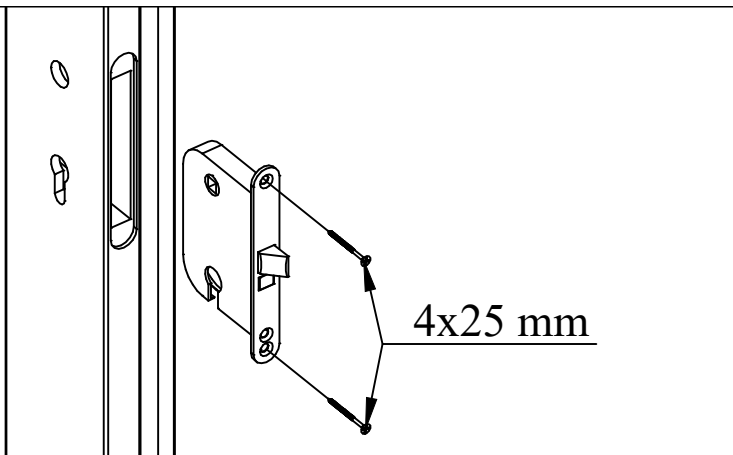

04

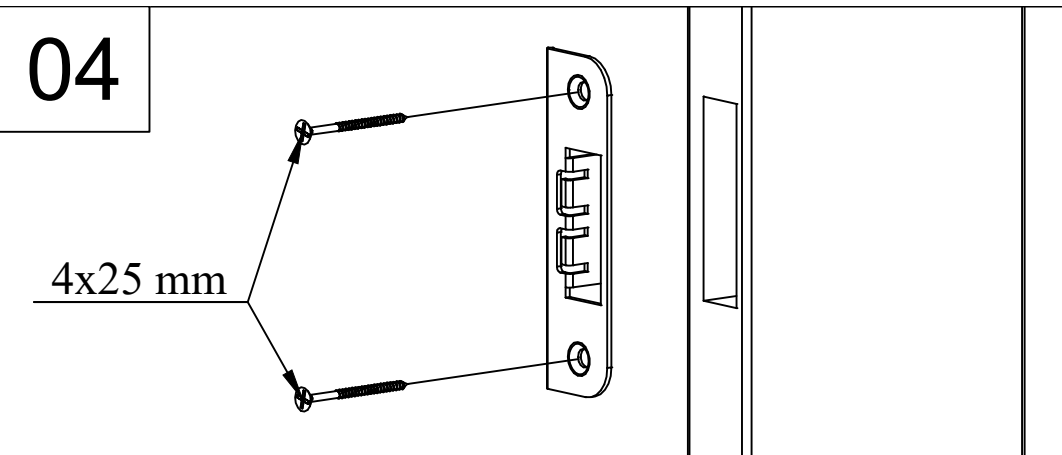

02

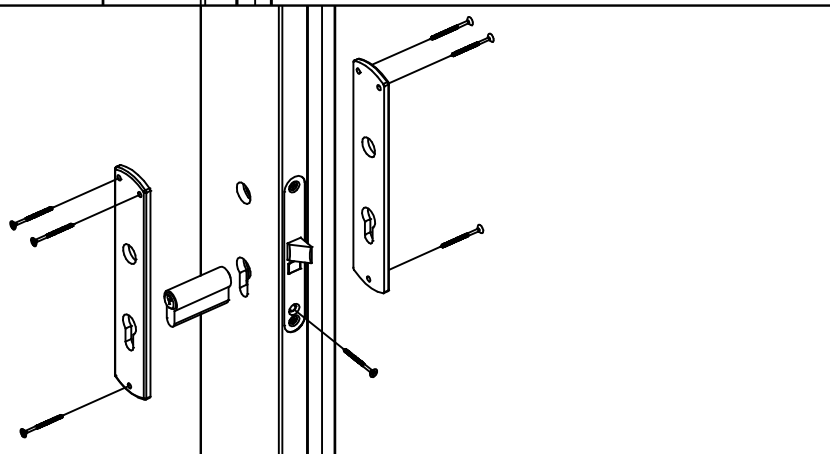

05

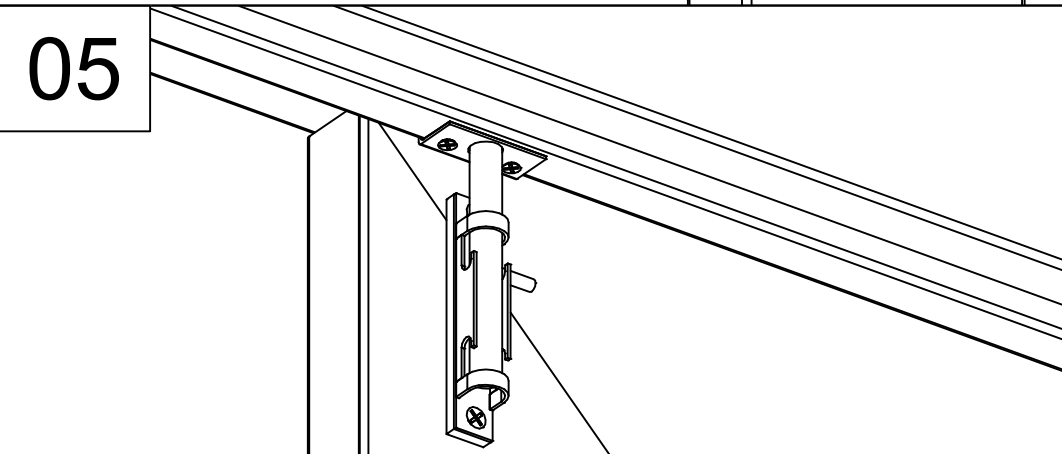

03

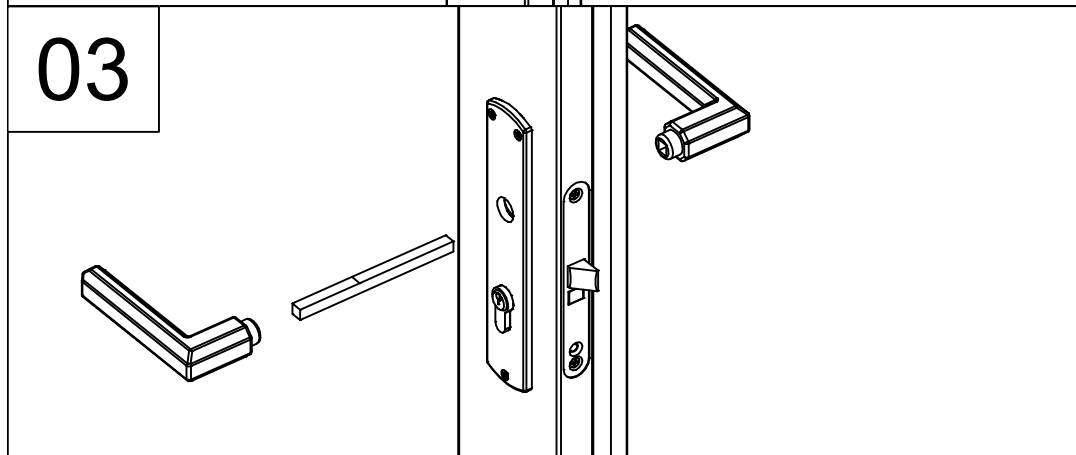

06

